



CITY OF YELLOWKNIFE  
NORTHWEST TERRITORIES, CANADA

# 2012 Budget Update

Programs

Services

Capital Improvement Plan



# THE CITY OF YELLOWKNIFE, NORTHWEST TERRITORIES

## 2012 Budget Update - Programs, Services and Capital Improvement Plan

### OUR VISION STATEMENT:

#### Community Vision:

A welcoming, inclusive, vibrant and family-oriented City with a strong sense of community pride and volunteerism. We will strive to be self-sufficient leaders in business and education, while actively promoting and protecting our unique history, culture and natural beauty.

#### Council Mission:

Council will provide leadership, vision and direction in responding to the needs and aspirations of the community. To meet those needs and aspirations, Council will work co-operatively with staff and residents to provide municipal infrastructure, programs and services that are fiscally responsible and sustainable.

#### Corporate Vision:

To be the most inclusive, progressive and well-managed community in Canada.

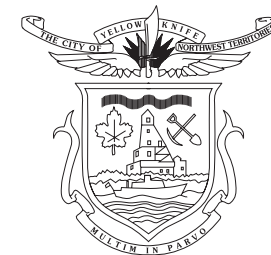

**PHOTO CREDITS**

**Cover:** Les Girrior  
**Page 31:** Jiri Hermann  
**Page 32:** Jiri Hermann





GOVERNMENT FINANCE OFFICERS ASSOCIATION

*Distinguished  
Budget Presentation  
Award*

PRESENTED TO

**City of Yellowknife**

**Northwest Territories**

For the Fiscal Year Beginning

**January 1, 2011**

*Linda C. Danson Jeffrey R. Egan*

President

Executive Director

## GFOA AWARD

The Government Finance Officers Association of the United States and Canada (GFOA) presented a Distinguished Budget Presentation Award to the City of Yellowknife for the triennium budget beginning January 1, 2011. In order to receive this award, a government unit must publish a budget document that meets program criteria as a policy document, as an operations guide, as a financial plan and as a communications device.



**PREPARED BY THE CITY OF YELLOWKNIFE**

4807 52 Street

Yellowknife, NT X1A 2N4

Canada

(867) 920-5600

*[www.yellowknife.ca](http://www.yellowknife.ca)*

**FOR MORE INFORMATION CONTACT:**

CARL BIRD - Director, Corporate Services

*[cbird@yellowknife.ca](mailto:cbird@yellowknife.ca)*

CHRISTINE SIU - Manager of Taxation, Budget & Evaluation

*[csiu@yellowknife.ca](mailto:csiu@yellowknife.ca)*

at the above address or e-mail



## TABLE OF CONTENTS

---

1)	<b>Budget Message</b> .....	1
2)	<b>Reader's Guide</b> .....	11
3)	<b>Budget Policies</b> .....	19
4)	<b>Community Profile</b> .....	29
5)	<b>Council's Goals</b> .....	37
6)	<b>Budget Summary</b> .....	39
7)	<b>Staffing Summary</b> .....	43
8)	<b>General Fund</b> .....	47
	a) Fiscal Services .....	51
	b) Mayor & Council .....	53
	c) City Administrator .....	57
	d) Corporate Services .....	69
	e) Economic Development .....	85
	f) Community Services .....	95
	g) Public Safety .....	125
	h) Planning & Development .....	139
	i) Public Works & Engineering .....	149
9)	<b>Solid Waste Management Fund</b> .....	177
10)	<b>Water &amp; Sewer Fund</b> .....	181
11)	<b>Land Development Fund</b> .....	189
12)	<b>Service Connection Failure Assistance Fund</b> .....	193
13)	<b>Capital Fund</b> .....	197
	a) 2012 Capital Projects	
	• General Government .....	205
	• Community Services .....	227
	• Public Safety .....	245
	• Planning & Development .....	251
	• Public Works & Engineering .....	254

## TABLE OF CONTENTS

---

b)	2013 Capital Projects	
	• General Government.....	309
	• Community Services.....	314
	• Public Safety.....	324
	• Planning & Development .....	324
	• Public Works & Engineering.....	327
c)	2014 Capital Projects	
	• General Government.....	333
	• Community Services.....	336
	• Public Safety.....	343
	• Planning & Development .....	343
	• Public Works & Engineering.....	347
14)	Reserve Fund .....	353
15)	Long-Term Debt.....	355
16)	10-Year Financial Plan.....	361



## SUPPLEMENTARY BUDGET MESSAGE

---

December 5, 2011

At the Special Council meeting held December 5, 2011, Council approved changes to the draft 2012 – 2014 Budget as follows:

- That the 2012 citizen survey be deferred until 2013;
- That the Solid Waste levy increase be reduced to \$2.5 in 2012 and a \$2 increase be added in 2013;
- That the tipping fee increase be reduced to 10% in 2012 and a 10% increase be added in 2013;
- That the Side Door Youth Centre Lease Agreement \$45,000 be reallocated from Core Grant to Community Services O&M;
- That the Core Grant be reduced by \$40,000 and the Special Grant be reduced by \$5,000;
- That the transfer from Solid Waste to General Fund be reduced by \$24,400.

Council adopted the 2012 Budget with revenues of \$60,419,000, expenditures of \$61,578,000 including capital investments of \$17,968,000, amortization of \$9,192,000, debt proceeds of \$0 and debt principal repayments of \$649,000. Council also adopted the 2013 and 2014 Budgets in principle.

---



THIS PAGE LEFT BLANK INTENTIONALLY



## BUDGET MESSAGE

---

### 2012 Budget Message

In the proposed 2012 Budget, the City maintains the quality of service levels while meeting the pressures created by reduced growth in the commercial and residential assessment base, changing community needs and increasing cost to provide services to residents.

The guiding principles in the preparation of this budget can be summarized as follows:

- Maintain existing service levels;
- Incorporate a proactive infrastructure renewal plan, specifically the replacement of corrugated metal sewer pipe;
- Identify and incorporate efficiencies wherever possible;
- Implement a progressive development incentive program;
- Align with and support Council's goals and objectives;
- Align with and support Council's adopted financial and budget policies.

Council and staff strive to provide services and programs in a cost-efficient and effective manner. The City will continue to evaluate programs and services on an ongoing basis, with any cost reductions being incorporated and reported in future budgets. The performance measures reported in this budget document will continually be refined and modified to assist in the decision making processes of both Council and Administration.

Prior to examining the highlights and challenges in the 2012 Budget, it is beneficial to discuss some of the highlights from 2011.

### 2011 Highlights

\$22.7 million increase in taxable assessment in 2012.

- This represents a 1.1% increase in assessed value and would equate to a \$290,000 increase in tax revenue for 2012.
- Not a sustainable level without tax increases. While assessment growth is on the rise, it is still too low to fully address the expenditure pressures on the City.
- In order to have zero tax increase, an additional \$649,000 in revenue growth would be required. That would require an additional \$50.8 million increase in taxable assessment.

The Smart Growth Development Committee

- Deals with issues relating to land use and development density, transportation, ecological preservation, and urban design.

- The Downtown Enhancement Committee has been dissolved and its roles and budget have been rolled into the Smart Growth Development Implementation Committee's mandate.

Community Energy Plan (CEP)

- A follow-up community energy profile was initiated. The process builds on the 2004 energy baseline work and will be used to track the progress of the Community Energy Plan. The process is the final step in the City's Partners for Climate Protection five-step process.
- The City worked with Northland Utilities to test 20 LED streetlights in four residential street locations. The intent of the pilot program was to confirm the technology can meet roadway standards, examine its overall performance and identify preferred suppliers.
- Facilities managers completed a number of small energy efficiency projects including a lighting upgrade at the Baling Facility.

District Energy System

- Failed borrowing referendum
- Continued to pursue a relationship with a private sector partner in order to attempt to move this project forward without municipal borrowing.

The Infrastructure Gap

- The Infrastructure Needs Assessment of 2006 estimated the infrastructure gap at \$67.8 million by 2016.
- Undertook an Infrastructure Asset Analysis during 2011 as part of the development of a long-term Asset Management Plan.
- Analysis indicates that without an increase in investment, the infrastructure gap will have grown to \$74.1 million by the end of 2016.
- In 2011 the City worked on a number of projects:
  - New water treatment plant. Total cost for this project will exceed \$20 million.
  - \$7.2 million on water and sewer projects
    - \$2.8 million on water and sewer replacement:
    - \$4.4 million on water treatment plant, pumphouse and liftstation upgrades.
  - \$2.8 million on roads and sidewalks repair.
  - In order to better address the infrastructure gap, the City began the process of developing a long-term asset management plan.

Long-Term Strategic Plan

- Developed by the City to guide decision making over the next 10 - 20 years. The plan is community-based, and the City has committed to fulfill the community vision through four overriding goals in the years to come.

# BUDGET MESSAGE

## Budget Summary

For 2012, The City of Yellowknife is budgeting for total revenues for all funds of \$60,672,000 from all sources. \$23.6 million (38.96%) will be from user charges, \$23.2 million (38.22%) from taxation, \$13.7 million (22.63%) from government transfers and investment income and \$120,000 (0.2%) from investment income.

### Revenues by Source

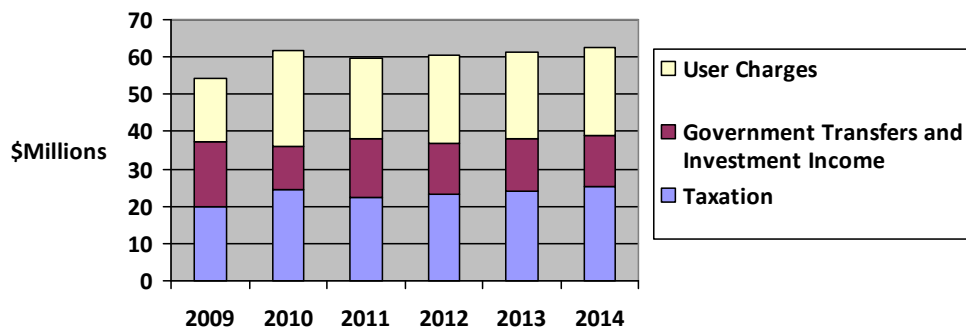

Total expenditures, net of amortization expense, will be \$61,575,000. The allocation of those expenditures is as per the following:

### Expenditures by Object (2012)

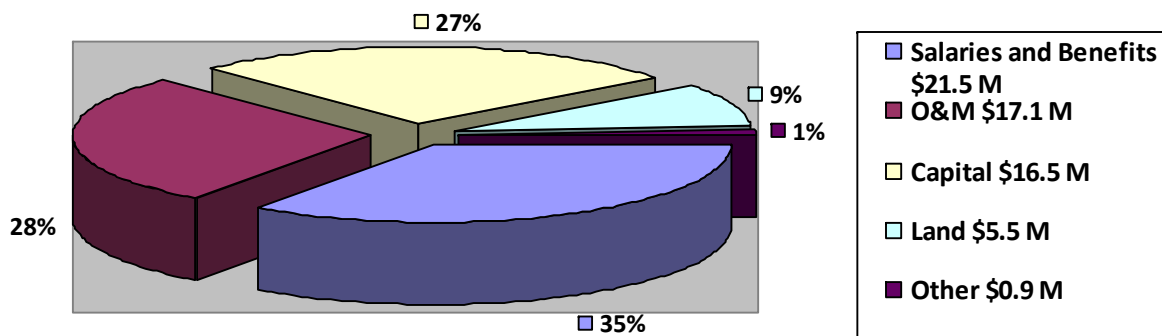

# BUDGET MESSAGE

## General Fund

The General Fund is in fair condition, after taking into consideration the inflationary and growth-oriented cost concerns and the slower than anticipated growth in the residential and commercial assessment base.

For the 2012 budget, the City of Yellowknife developed a Municipal Pricing Index (MPI) to demonstrate what the inflationary pressures are on the City's expenditures. Using that MPI and accounting for revenue growth, the City can demonstrate what would be the tax increase necessary to meet those inflationary pressures on operations. The MPI will be reviewed each year and adjustments made as necessary.

The City is experiencing some growth in the commercial and industrial sector while at the same time adjusting to the continued demolition of buildings and facilities on the Con Mine property, resulting in a continuing reduction in the assessment value in the mining sector. Since

ownership of Miramar Con Mine was taken over by Newmont Mining Corporation, the demolition of buildings and infrastructure has escalated and was completed in 2011. The remaining revenue sources are stable. The growth in the residential sector shows signs of improving after the economic downturn of 2009. To date, 24 lots have sold in stage 1 of the Niven Lake Phase VII subdivision. Development is also occurring in the Con/Rycon subdivision. This bodes well for a positive increase in the assessment base for 2012.

Every department reviewed its expenditures in detail and, in many cases, expenditure increases were reduced or eliminated by implementing efficiencies and reducing duplication of effort.

The General Fund expenditures are funded 71.26% by property taxes, 22.91% by user fees, 4.88% by interfund transfers and 0.94% by other revenue sources.

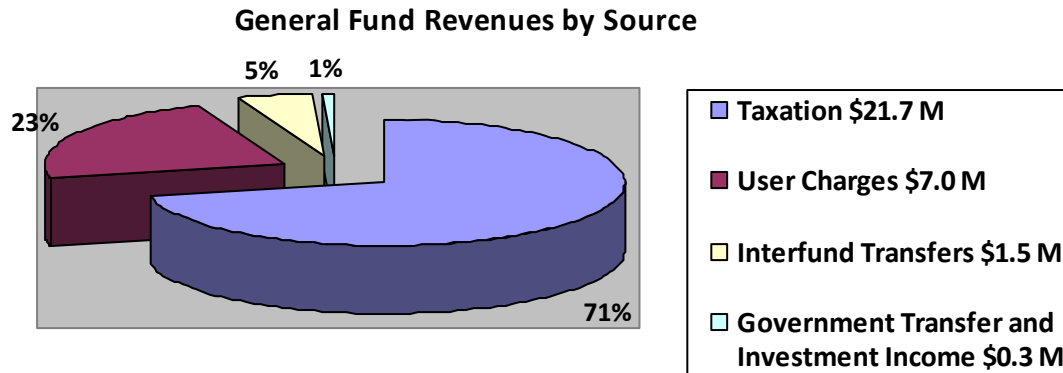

The City is experiencing inflationary and growth-oriented cost increases to provide existing services to the residents and these increases exceed the revenue growth. The most significant changes in revenues and expenditures are shown in the chart on the following page.

# BUDGET MESSAGE

## Adjustments in Proposed 2012 Budget

	Existing Standard				Sub-total	Service Level Changes			Sub-total	2012 Impact
	FTE's	Inflation	Growth	Capital Impact		FTE's	Service Level Changes	New Service/Program		
<b>GENERAL FUND</b>										
<b>Operating Expenditures</b>										
General Government - Staffing		164,000			164,000		49,200		49,200	213,200
Community Services - Staffing		137,200			137,200	0.38	12,700		12,700	149,900
Planning and Development - Staffing		8,200			8,200					8,200
Public Safety - Staffing		76,300			76,300					76,300
Public Works & Engineering - Staffing		23,600			23,600					23,600
City Clerk Advertising		51,836			51,836					51,836
Election/ Plebiscite		37,500			37,500					37,500
Public Transit Contracted Costs		30,900			30,900					30,900
IT O&M Costs		35,633	17,817		53,450					53,450
Insurance Premium		17,000			17,000					17,000
Radio Licensing					0		13,000		13,000	13,000
Corporate Services Contracted Costs		23,100			23,100					23,100
Power and Heating Fuel Costs		144,900			144,900					144,900
Vehicle O&M		68,880			68,880					68,880
Vehicle Fuel		46,200			46,200					46,200
Bad Debts		100,000			100,000					100,000
Credit Card Fees		14,600			14,600					14,600
Assessment Contracted Costs		7,800			7,800					7,800
MED Contracted Costs- Dog Pound		21,900			21,900					21,900
Emergency Services O&M Costs		30,000			30,000					30,000
Library O&M Costs		19,300			19,300					19,300
Other		73,800			73,800					73,800
	0.00	1,132,649	17,817	0	1,150,466	0.38	74,900	0	74,900	1,225,366
<b>Cuts to Operating Expenditures</b>										
Reduction in Pool's Maintenance Costs		(30,500)			(30,500)					(30,500)
Reduction in Communication Strategy Study		(50,000)			(50,000)					(50,000)
Reduction in Administration Contingency		(75,000)			(75,000)					(75,000)
Reduction in Accrued Future Benefits		(24,900)			(24,900)					(24,900)
Reduction in Long Service Bonus		(13,000)			(13,000)					(13,000)
	0	(193,400)	0	0	(193,400)	0	0	0	0	(193,400)
<b>Net Change in Operating Expenditures</b>	0.00	939,249	17,817	0	957,066	0	74,900	0	74,900	1,031,966
<b>Change in Operating Revenues</b>										
Assessment Growth (excluding Mill Rate Increase)										(290,000)
Decrease in Interest Income										25,000
Decrease in Tax Penalties										31,000
Decrease in Power Distribution Franchise										15,000
Decrease in Planning & Development User Fees										60,600
Increase in Public Safety User Fees										(118,000)
Increase in Community Services User Fees										(42,550)
Increase in Public Transit Revenue										(12,000)
Increase in Transfer to Capital Fund										16,000
Increase in Transfer from SWM & W&S Fund										(106,700)
Other										38,000
										<u>648,316</u>

Tax revenue increase resulting from recommended adjustments

**2.87%**



## BUDGET MESSAGE

---

The chart shows that an additional \$409,300 in salaries is required simply due to inflationary pressures in order to maintain existing service levels. Other inflationary costs include \$145,000 increase in power and heating fuel costs for City facilities and \$115,000 increase in vehicle O&M and fuel. Cost increases related to service level increases and new programs are \$75,000, related primarily to communications improvements at the City. The City is also increasing its bad debt expense by \$100,000 per year based on our historical experience with debt collection. Other O&M increases of \$381,000 are partially offset by O&M reductions of \$194,000.

The proposed 2012 Budget contemplates a small increase in casual positions.

### General Fund Summary

Overall, the City would experience a net increase in revenues of \$384,000 without any tax increase, against a net increase in expenditures of \$1,032,000. In order to make up the net difference of \$648,000, this recommended budget proposes a 2.87% mill rate increase related to operations to balance the General Fund in 2012. This will result in an increase in municipal taxes of \$24 for each \$100,000 of assessed value for a single family residential home. The average homeowner will incur an increase of \$47 in municipal taxes per year. It is expected that in 2013 and 2014 property tax increases of 2.66% and 2.82% will be required to balance the General Fund.

Based on projected revenues and expenditures, the City will not meet the objectives of the Budget Stabilization Fund Policy, as the fund balance will be 6.81% of budgeted expenditures rather than the recommended 10%. As well, the fund will not be transferring the amount of tax revenue to the Capital Fund as required by policy. The proposed transfer of \$1.452 million is \$866,000 short of the 10% requirement under policy.

**General Fund Balance**

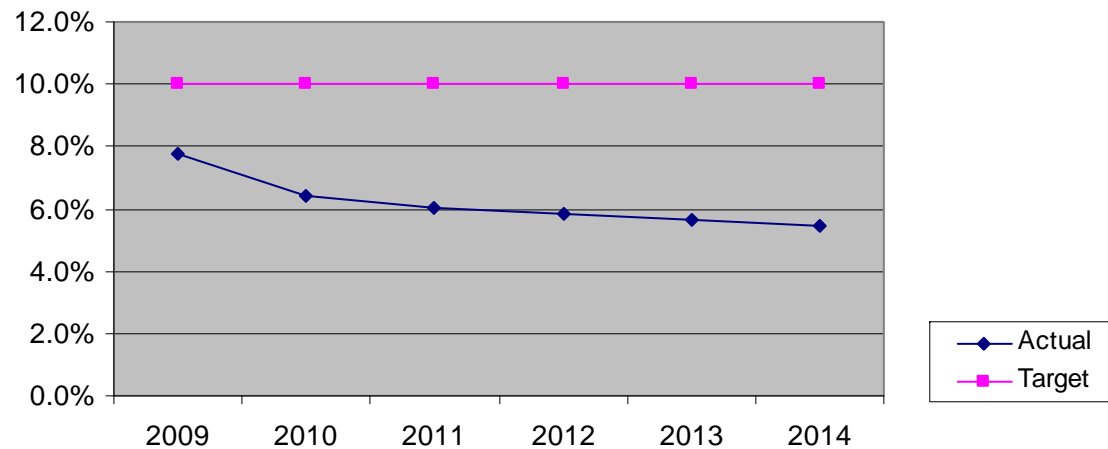

## BUDGET MESSAGE

---

### Water and Sewer Fund

The Water and Sewer Fund remains in a relatively stable position as a result of past initiatives that were taken by the City. The fund should continue to operate on a balanced basis, requiring minimal increases in rates for 2012 - 2014. The following actions are proposed to ensure continued stability of the Water and Sewer Fund:

- Rate increases of 3.0% on January 1 of each year for 2012 through 2014;
- A new utility account setup fee starting in 2012;
- The 30% transfer to the Capital Fund as required by budget policies will be reduced by \$200,000 plus the amount earned from the increase to the infrastructure replacement levy for 2012 through 2014.

The City will continue to review the water and sewer rate structure and water consumption to ensure continued improvement of the financial position of the fund.

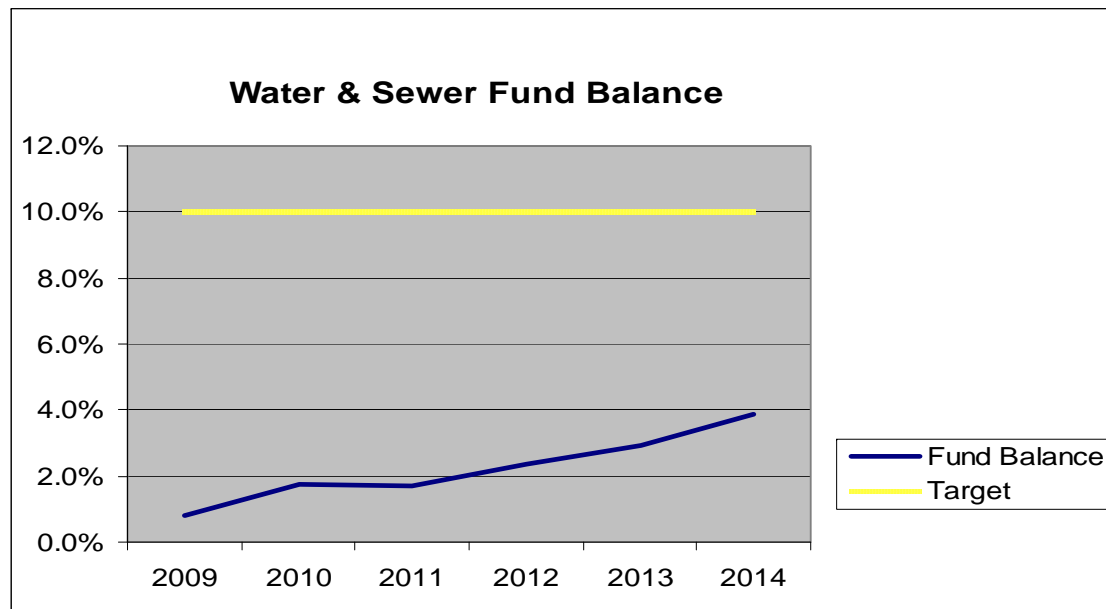

## BUDGET MESSAGE

### Land Development Fund

It is projected that the Land Development Fund will be in a deficit position of \$4.51 million by December 31, 2011. This is due to investments in land for resale in Engle Business District, Niven Lake Phase VII and projected investments on 50<sup>th</sup> Street.

During 2012-2014, the fund will continue to focus on planning and development of Niven Lake Phase VII & VIII and Engle Business District. Also, with the investment in land in the downtown core, the City will attempt to encourage downtown revitalization projects which would be eligible for tax incentives under the Development Incentive Program.

The steady pace of sales in Niven Lake Phase VII which started in 2010 continued for 2011. To date, 24 of 30 lots have sold in Stage 1 of that subdivision. For Stage 2 of Phase VII, 9 of 37 single-family homes have been sold in the first year of availability, and an additional 2.09 hectares of land have been sold and are currently being developed for a multi-residential subdivision. An additional 0.42 hectares are available to the same developer on a right of first refusal basis when the City is ready to develop that parcel.

The City has completed the design layout of Engle Business District (Phases I through III) for marketing and sale of industrial lots west of the airport. The Kam Lake bypass road – a four-kilometre road between Highway 3 just north of the golf course and the Kam Lake Industrial Park at Deh Cho Boulevard – has now been completed. Construction of the bypass road, a joint project between the GNWT's Department of Transportation and the City, which commenced early in 2009, was substantially completed in 2011. Completion of hard surfacing of the road and construction of a pedestrian and bike friendly greenway alongside the road is expected by 2013. The City is funding its share of the construction from the \$800,000 allocated from the Community Capacity Building Fund and from sales of industrial lots in the Engle Business District. If sales are light, the City may need to borrow money to pay for its share of the bypass road. The City will be implementing a Development Incentive Program, part of which will serve to encourage the transfer of commercial, industrial and light industrial activities from the Old Airport Road corridor to the Engle Business District. This should serve to increase the interest in the purchase of lots in the Business District.

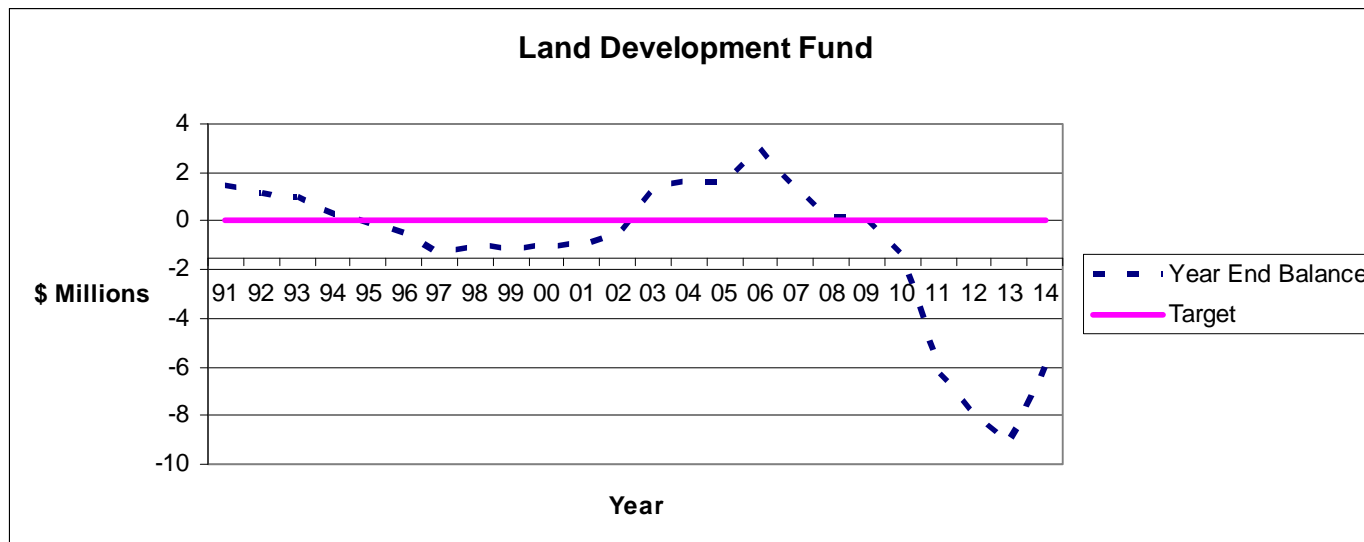



### Solid Waste Management Fund

The Solid Waste Management Fund generates revenues by charging a \$12 solid waste levy for single family residences, and relies on tipping fees collected at the landfill for multi-family (five units or more) and commercial/industrial operations, as these groups are charged for waste hauling and disposal by the waste collection operator. This system is designed on the user pay principle of the more waste you produce the more you should pay for disposal, and it encourages residents and businesses to reduce, recycle and reuse. According to data collected, the percentage of materials recycled/diverted increased from 7.5% in 2005 to 11.1% in 2006. This has increased to 14.2% for 2009 and is projected to increase to 16.1% for 2012.

O&M expenditures at the Solid Waste Management Facility have resulted in a forecast negative fund balance of \$349,000 for 2011. In order to mitigate this and ensure a balanced fund in future years, expenditures

have been reviewed and will be maintained at the 2011 levels. Fee increases are being proposed which will ensure that the Solid Waste Fund returns to a stable position over time. The proposed fee increases for 2012 are:

- A \$5 increase to the single-family unit solid waste monthly levy from \$12 to \$17 (41.7%);
- Tipping fees for multi-family and commercial/industrial operations are to be increased by 19.3%.

As a result of these fee increases, it is anticipated that the Solid Waste Management Fund balance will be \$135,000 by the end of 2014. This will not meet the budget policy requirements as the fund balance will be 6.2% of the expenditures instead of the required 10%.

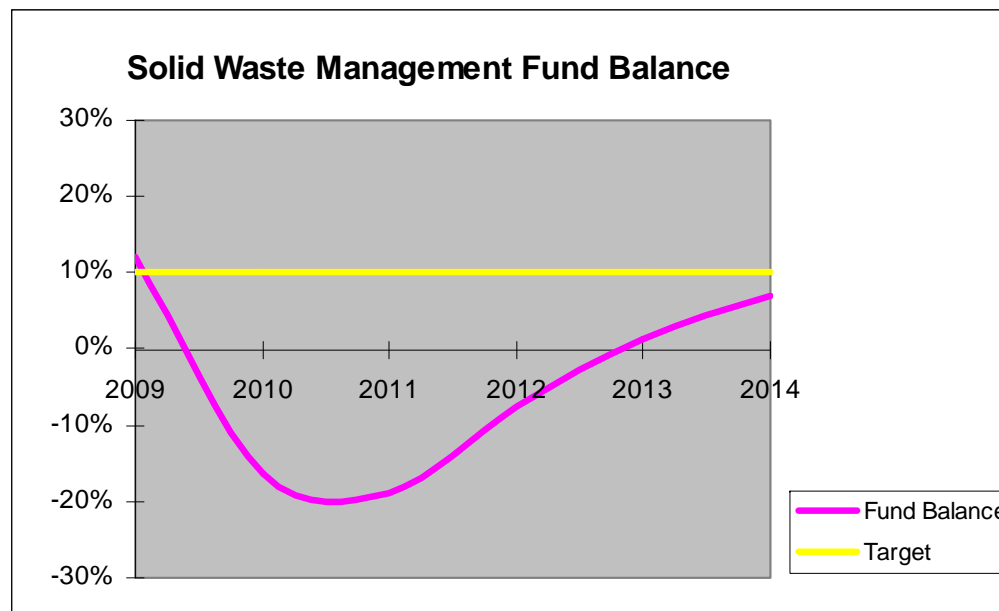

## BUDGET MESSAGE

---

### Capital Fund

Since 2007 City staff have also been successful in accessing over \$8 million in funding from various federal and territorial sources for important projects related to Smart Growth development, recreational facilities improvements, Community Energy Plan projects and economic development activities. Some significant examples include:

- Smart Growth funding from the federal government under the SINED and the Federation of Canadian Municipalities (FCM) Green Municipal Funding (GMF) envelopes
- Affordable Housing Strategy from Canada Mortgage and Housing Corporation and NWT Housing Corporation
- Geothermal Energy Potential at Con Mine from the federal government under both the SINED and GMF envelopes as well as from the GNWT – Environment and Natural Resources (ENR).
- Build Canada Program funding from Infrastructure Canada.

Capital Fund's sources of revenue, totaling \$18.5 million are as follows:

- GNWT Formula Funding \$6.75 million;
- Other government grants \$6.81 million (including Gas Tax Rebate Program of \$4.5 million, MACA Capital Grant of \$2.2 million);
- Property taxes \$1.4 million; and
- User fees \$3.4 million

The above revenue will be used to finance capital projects and reserve funds. The reserve funds, such as the Major Community Facility Reserve and the Mobile Equipment Reserve, are used to set aside funds for major capital expenditures and reduce the City's need to borrow.

As discussed in the 10-Year Financial Plan section of the budget document, the City has been able to reduce its reliance on long-term debt to fund core capital requirements, such as road rehabilitation. This practice will reduce the City's debt-servicing costs over the next ten years and allow Council to focus on financing issues related to major community projects. No borrowing is planned to support the capital projects included in the 2012 Budget.

In 2012 the proposed budget is planning for new capital projects worth \$25.4 million (2011 - \$ 26.4 million). The Gas Tax Rebate Program,

Build Canada Fund, Formula Funding and Capital Grants from MACA have enabled the City to maintain high levels of capital spending.

The City's future capital plans rely heavily on funding sources outside of the City's control. Grants from the federal and territorial governments are expected to continue. The long-term future of these funding arrangements has become more certain as the current federal government has entrenched the Gas Tax Rebate Program in budget legislation. However, either level of government could decide to reduce or eliminate these grant programs as a way to save money in their respective budgets. We can say with certainty that stimulus-type funding such as the Build Canada Program is one-time only funding and we cannot expect to see more of the same type of funding, especially at the levels we saw in 2008 and 2009.

Another concern is that transfers of tax revenues from the General Fund have decreased significantly over the past several years. Budget policy requires that at least 10% of tax revenues be directed to the Capital Fund each year. The proposed transfer of \$1.452 million for 2012 falls \$866,000 short of this target. This is being done in large part to reduce the requirement to increase taxes. However, it does reduce the funds available for capital spending and thus has a negative impact on the City's desire to reduce its infrastructure gap.

### Summary of Major Capital Projects

**Yellowknife Smart Growth Redevelopment Plan** – Several streetscaping and beautification projects impacting the City's core areas, primary commercial districts, and entranceways to the City will be undertaken. In addition the Kam Lake bypass road, including the development of a pedestrian and bike-friendly greenway, will be completed.

**Community Energy Plan** – In 2006, Council adopted the Community Energy Plan (CEP). In 2007, Council endorsed the implementation strategy recommended by the Community Energy Plan Committee. The 2012 Budget sets aside \$500,000 each year to implement the Community Energy Plan.

The City hopes to move forward on the Con Mine geothermal project in conjunction with a private sector partner. This project would provide a

## BUDGET MESSAGE

---

district heating system for commercial buildings in the downtown core and would significantly reduce private sector reliance on diesel and oil based heating systems. An implementation plan is being developed that will result in a project investment decision in 2012.

**Water Reservoir Expansion and Pumphouse Replacement** – The City continues to work on the replacement of Pumphouse #1, the expansion of the water reservoir and the replacement of the water treatment plant (WTP). The City is using the Gas Tax Rebate Program to finance this project. The contract for engineering and design of the WTP has been awarded. The contract for construction and installation will be awarded early in 2012, with completion targeted for 2014.

**Water and Sewer Infrastructure Replacement** – The City started its corrugated metal pipes (CMP) replacement program in 1984 and, based on planned expenditure levels, the program will be complete by 2016.

Over the next three years, the City is planning on spending \$8,725,000 for the replacement of CMP water and sewer mains. In 2012, work will be completed in the following areas:

- Knutsen Avenue, resurfacing;
- Matonabee Street, CMP replacement.

Equally as important as the underground systems are the buildings and equipment that are necessary to supply safe clean water to our residents. Important projects include the ongoing replacement of pumps in the City's pumphouses and liftstations and the replacement and maintenance of fire hydrants.

**Road Rehabilitation** – The 2012 Budget recommends spending \$6,800,000 on road rehabilitation over the next three years. Work will take place in N'dilo in 2012.

**Communications Infrastructure Upgrade** – The City's radio system supports voice radio communications for the Public Safety, Public Works and Community Services departments. A recent study determined that current infrastructure has significant shortcomings, in particular the lack of compliance with National Fire Prevention Association standards. The City is investing just under \$3 million over four years to bring our

communications infrastructure up to standard. This investment will be completed in 2012. In the long run, this should also reduce O&M costs. As well, the modernized infrastructure will be able to support an updated dispatch service in the city.

**Fleet Management and Other Projects** – Fleet management provides an ongoing preventive maintenance and readiness system. Other capital projects protect the City's investment in core assets which include but are not limited to the swimming pool, arenas, library, trail networks, pumphouses and liftstations. Equipment upgrades provide the City's workforce with the necessary tools to safely deliver high quality and efficient programs and services.



## READER'S GUIDE

---

This budget document contains all seven of the funds that the City operates: the General Fund, the Water and Sewer Fund, the Solid Waste Management Fund, the Land Development Fund, the Capital Fund, the Service Connection Failure Assistance Fund and the Reserve Fund.

### **BASIS OF BUDGETING**

Readers and users of governmental budgets and financial statements are frequently confused by what they see. This confusion stems from the style of accounting which is required for all government jurisdictions in order to segregate and account for resources.

The City of Yellowknife develops the revenue and expenditure estimates contained in its annual budget in a manner that follows generally accepted accounting principles (GAAP) for local governments. The City uses the accrual accounting method for recording expenditures and revenue. The budget is prepared on this basis.

The budget is organized on the basis of Funds. Each Fund is considered a separate budgetary and accounting entity; municipal resources are allocated to, and accounted for, in individual Funds based upon the purposes of carrying on specific activities or attaining certain objectives in accordance with special regulations, restrictions or limitations.

### **NEW ACCOUNTING STANDARDS**

The Canadian Institute of Chartered Accountants' (C.I.C.A.) *Public Sector Accounting Board* (P.S.A.B.) was created in 1981, after an in-depth C.I.C.A. research study found dramatic inconsistencies in the way the federal and provincial governments accounted for and reported their financial position and results. A study conducted in 1985 for local governments found similar problems.

In 1989 P.S.A.B. began its local government initiative of recommending standards of good municipal accounting and financial reporting practices. As in most provinces and territories, municipalities in the NWT are not yet required to follow the P.S.A.B. recommendations. Because changing financial reports and accounting records can be time consuming, the recommendations are being adopted slowly throughout Canada. The City of Yellowknife adopted the P.S.A.B. recommendations starting with the 2000 budget and 1998 financial statements.

One significant change is the presentation of the City's Statement of Revenue and Expenditures. This statement is now named the Statement of Financial Activities, as it includes more than just revenue and expenditures. The overall objective of the Statement of Financial Activities as identified by P.S.A.B. is to ensure that all revenues, expenditures and changes in fund balances are recorded and reported on the Statement of Financial Activities.

The Statement of Financial Activities is intended to present an understandable overview of the results of operations for the municipality as a whole. Thus, for each financial statement item, the Statement of Financial Activities would present the total for the municipality. As such, any interfund transactions would be eliminated.

Reporting all revenues and expenditures on the Statement of Financial Activities ensures that information is presented about the municipality's sources, allocations and uses of financial resources and provides the user with an indication as to whether revenues were sufficient to meet expenditures.

Another significant change is how municipalities are required to account for Tangible Capital Assets (TCA). Beginning with fiscal years starting in 2009, municipalities are required to amortize the cost of TCA over their useful lives in accordance with PSAB 3150. Prior to that, they were expensed in the year they were acquired or in which expenditures were incurred. The City of Yellowknife will prepare its financial statements in accordance with PSAB 3150. Starting in 2012 the budget will reflect this new method of presentation.

### **CITY FUNDS**

The City operates various Funds which are defined as follows:

#### **General**

This Fund's activities include the municipal services and programs not accounted for in other funds. These activity costs are recovered through municipal property taxes, user fees and grants from other levels of government.

#### **Land Development**

This Fund's activities include all aspects of

acquiring, developing and disposing of municipal lands including the following:

- preparation of secondary development plans and detailed urban designs for development areas;
- property appraisal, legal survey and mapping work related to lands for disposal;
- engineering and constructing infrastructure required in the development area; and
- recovering, through sale of public lands, all direct, indirect and associated costs related to municipal lands in accordance with the Land Administration By-law.

Utility infrastructure installed on public rights-of-way in new subdivisions/development areas becomes the responsibility of the Water and Sewer Fund upon final acceptance by the City. Until that time, it is the responsibility of the Land Development Fund.

### **Solid Waste Management**

This Fund's activities include all aspects of collection, processing and recycling. This includes landfill operation, baling facility operation and maintenance, as well as recycling, sorting and shipping. These direct and indirect costs are recovered through user fees.

### **Water & Sewer**

This Fund's activities include all aspects of establishing, operating and maintaining buildings, equipment and work related to the supply and process of potable water; the distribution of potable water; and the collection, treatment and disposal of sewage. These costs are recovered through charges to service users.

### **Capital**

This Fund accounts for capital projects relating to the delivery of services and programs in all Operating Funds.

### **Reserve**

This Fund accounts for the balances and transfers of reserve funds.

### **Service Connection Failure Assistance**

This Fund provides for the repair and maintenance of water supply and sewage lines from City mains to the customers' buildings and provides assistance to customers.

In order to match all costs associated with a particular Fund (e.g. billing and collection of revenues), each fund pays an administration fee to the General Fund. The administration fee for the Water & Sewer Fund is based on 15% of its revenue and the Solid Waste Management Fund is based on 10% of its revenue. For the Land Development Fund, the administration fee is based on estimated administrative costs.

## **ORGANIZATIONAL STRUCTURE**

The City's expenditures and revenues are organized into hierarchical categories: Departments, Divisions and Programs. To understand the Budget better, a basic understanding of these terms is required.

***Department*** A department represents the highest level of summarization used in the City's financial structure. The function classification represents a grouping of related operations and programs aimed at accomplishing a broad goal or rendering a major service. In addition to Administration, there are six departments in the City's financial structure as follows:

Department of Community Services  
Department of Corporate Services  
Department of Economic Development  
Department of Public Safety  
Department of Planning and Development  
Department of Public Works and Engineering



## READER'S GUIDE

### The Relationship Between Funds and Departments

Fund	Budget Summary	Department							
		Mayor & Council	City Administrator	Corporate Services	Economic Development	Community Services	Public Safety	Planning & Development	Public Works & Engineering
General Fund	X	X	X	X	X	X	X	X	X
Solid Waste Management Fund	X								X
Water & Sewer Fund	X								X
Land Development Fund	X						X		
Services Connection Failure Assistance Fund	X								X
Capital Fund	X	X	X	X	X	X	X	X	X
Reserve Fund	X								

**Division** Departments can be further subdivided into divisions which are usually associated with functioning working groups having more limited sets of work responsibilities. Their primary purpose is organizational and budget accountability. An example is the Building Inspections Division within the Department of Planning and Development.

**Program** Divisions may be further subdivided into programs (groups of activities). A program is used to account for a specific public service performed within a division in the pursuit of individual goals and objectives. A program is aimed at accomplishing a specific service or regulatory program for which the City is responsible. An example of a program would be Capital Planning Activities managed by Public Works & Engineering Directorate.

#### **FORMAT OF THE BUDGET DOCUMENT**

The budget document is organized in the following manner: Goals and objectives are set out at the Fund, Department, Division and Program levels: financial information is provided for the last completed fiscal year, budgeted current year expenditures, estimated current year expenditures and the recommended budget amounts for the next three years. The financial costs are summarized at the object level as well as at the activity level. In the summary section, financial costs are also presented by major function and by major object.

#### **DEFINITIONS**

To assist readers in understanding the budget document, the following definitions are provided:

**Accrual Basis Accounting** A basis of accounting in which transactions are recognized at the time they are incurred, as opposed to when cash is received or spent.

**Activity** The department/division's effort which contributes to the achievement of a specific set of program objectives, which is the smallest unit of the program budget.

**Assessed Valuation** The valuation set upon real estate and certain personal property by the Assessor as a basis for levying property taxes.

**Budget** A plan that sets out the City's goals and objectives for a specific period of time (fiscal year) and all planned revenues and expenditures for the budget period. The budget is also a policy document, an operations guide and a communication device that is written so that all citizens have an equal opportunity to review the document and understand where their taxes are being spent.

**Capital Lease** A capital lease is one which, from the point of view of the lessee, transfers substantially all the benefits and risks incident to ownership of property to the lessee. The lessee should account for a capital lease as an asset and an obligation (debt).

**Consumer Price Index (CPI)** A statistical description of price levels provided by Statistics Canada. The index is used as a measure of the increase in the cost of living (i.e. economic inflation).

**Debt Service** The cost of paying principle and interest on borrowed money according to a predetermined schedule.

**Deficit** The excess of an entity's liabilities over its assets or excess of expenditures over revenues during a single accounting period.

**Environmental Services** A function encompassing all activities relating to solid waste management, mosquito abatement and other related activities.

**Evergreen Policy** In conjunction with the Information Technology Strategic Plan, a policy whereby 25% of the City's computer workstations are replaced annually.

**Expenditure** Charges incurred (whether paid immediately or unpaid) for operations, maintenance, debt servicing, acquisition of an asset or service, or settlement of a loss.

**Fiscal Policy** A government's policies with respect to revenues, spending and debt management as these relate to government services, programs and capital investment. Fiscal policy provides an agreed-upon set of principles for the planning and programming of government budgets and their funding.

**Fiscal Year** A twelve-month period designated as the operating year for accounting and budgeting purposes in an organization. The City's fiscal year is based on the calendar year.

**Formula Funding** A block of grant funding received from the Government of the Northwest Territories for capital or operation and

maintenance purposes. The funding is allocated to capital projects or operations, based on City Council's discretion.

**Full-time Equivalent Position (FTE)** A part-time position converted to the decimal equivalent of a full-time position based on 52 weeks per year. For example, a casual secretary who works three weeks full-time would be equivalent to .06 of a full-time position.

**Function** A group of related activities aimed at accomplishing a major service or regulatory program for which a government is responsible (e.g. public safety).

**Fund** A fiscal entity with revenues and expenditures which are segregated for purposes of carrying out a specific service or activity.

**Fund Balance** The cumulative total of fund revenue, expenditures, debt proceeds, debt repayment and interfund transfers.

**Gas Tax Rebate** This is the funding provided by Government of Canada as part of the New Deal for Cities and Communities. This federal initiative is based on a long-term vision of sustainability for Canadian cities and communities, including four interdependent dimensions: economic, environmental, social and cultural. The program is intended to achieve results leading to cleaner air, cleaner water and reduced greenhouse gas emissions. The City uses this funding to finance various projects that work towards these goals.

**Generally Accepted Accounting Principles (GAAP)** Uniform minimum standards for financial accounting and recording, encompassing the conventions, rules and procedures that define accepted accounting principles.

**Infrastructure** The physical assets of a government (e.g. streets, water and sewer system, public buildings, parks, etc.).

**Levy** Tax imposed for the support of government activities.

**Mill** The property tax rate which is based on the valuation of property. A tax rate of one mill produces one dollar of taxes on each \$1,000 of assessed property valuation.



## READER'S GUIDE

---

**Object of Expenditure** An expenditure classification, referring to the lowest and most detailed level of classification (e.g. office, labour, and operations and maintenance).

**Program** A group of related activities performed by one or more organizational units for the purpose of accomplishing a function for which the government is responsible.

**Reserve** An account used either to set aside budgeted revenues that are not required for expenditure in the current budget year or to earmark revenues for a specific future purpose.

**Tangible Capital Expenditure** This category of expenditures includes: land, buildings, structures, other permanent improvements, computer hardware and software and equipment. It also includes the costs necessary to plan, acquire, install or put these items into use. Capital expenditure should meet the following criteria:

- cost should exceed \$50,000;
- has an anticipated useful life of more than three years;
- can be permanently identified as an individual unit of property;
- constitutes a tangible, permanent addition to the value of City assets;
- does not constitute repair or maintenance;
- is not readily susceptible to loss.

**User Charge** The payment of a fee for direct receipt of a public service by the party who benefits from the service.

### **ABBREVIATIONS**

**Avg.** Average

**CCBF** Community Capacity Building Fund

**CTV Act** *The Cities, Towns and Villages Act*. The GNWT legislation which governs municipalities

**GNWT** The Government of the Northwest Territories

**IT** Information Technology

**IVR** Interactive Voice Response

**GFOA** Government Finance Officers Association of the United States and Canada

**MACA** The Department of Municipal and Community Affairs. The GNWT department responsible for enforcing legislation dealing with municipalities

**MCF Reserve** Major Community Facility Reserve

**MER Reserve** Mobile Equipment Replacement Reserve

**MSC Committee** Municipal Services Committee

**O&M** Operating and Maintenance

**PATA** *Property Assessment and Taxation Act*. The GNWT legislation which governs the City's authority to assess and tax

**PSAB** Public Sector Accounting Board of the Canadian Institute of Chartered Accountants

**PY** Person-Year

**RWED** Department of Resources, Wildlife and Economic Development. Effective April 1, 2005, this department was eliminated and two new departments created: Environment and Natural Resources (ENR) and Industry, Tourism and Investment (ITI)

**UPS** Uninterrupted Power Supply

**WSCC** Workers' Safety & Compensation Commission

### **Budget Process**

A budget is a plan that helps Council and Administration decide how much money will be needed to provide programs and services. A good prediction of the total amount needed can be arrived at by building the budget total from small pieces.

The budget process provides medium-term direction identified and quantified by Council and Administration. The budget process reflects goals, objectives and priorities of the municipality and focuses on the current year's operating and maintenance costs, the following three-year operations and maintenance planning, and the following three-year capital planning.



Council establishes civic policies that determine levels of services. Administration reflects these policies as it establishes operations and maintenance services and capital projects. These goals are revised throughout the budget process, and revisions occur in evaluating and prioritizing each program and project. Throughout the budget document, each department/division details its goals and objectives as defined below:

A **policy** is a plan, course of action or guiding principle designed to set parameters for decisions and actions.

A **goal** is a long-term, attainable target for an organization - its vision of the future.

An **objective** is a specific, measurable and observable result of an organization's activity which advances the organization towards its goal.

Council, at the beginning of a new term, adopts three-year goals, objectives and priorities. These are based on the goals and priorities identified in the Community-Based Strategic Plan. Administration, under the direction of the City Administrator, is responsible for ensuring that departmental goals and objectives meet Council's adopted goals and objectives. Administration establishes any guidelines considered necessary and specifically ensures that the City's financial and budget policies are adhered to. The schedule and approach to budget development is approved by Council and directed by the City Administrator.

The legal budgetary (expenditure) control in the City of Yellowknife is maintained at the Fund level. Council approves a budget for all funds which are consolidated into an annual municipal budget for all funds. Council, by resolution, must adopt an annual budget before a fiscal year begins.

Since 2002 the City has produced a three-year budget. Council formally adopts the first-year budget and adopts the second and third-year budgets in principle. Prior to City Council adopting the second and third-year budgets, Administration brings forward a report which will include: for capital projects, any variances between recommended projects or changes in financing and outline the reasons for them; for operating programs and services, any significant variances in expenditures and revenues and the reasons for them.

This budget review process takes six months of analysis by staff and

### ASSUMPTIONS

The 10-Year Financial Plan and this Three-Year Operating Budget reflect the required revenues and expenditures to maintain existing programs and services and to meet Council's goals and objectives as currently adopted. It also documents the progress that the City has made in attaining its financial goals and provides a clear path to a successful financial future.

Crucial to any forecasting are the key assumptions used in preparing this document. Projecting the future, whether three years or ten years, is often seen as valueless. However, using sound, practical financial policies coupled with solid assumptions, a long-term forecast can be a very useful tool.

### KEY ASSUMPTIONS

- The projected population figures are based on the GNWT's Bureau of Statistics population projections.
- For 2013 and 2014, property tax revenue was calculated using management's best estimation of construction during these periods.
- Operation and maintenance expenditures for 2013 and 2014 are based on management's current estimation of costs needed to provide the same level of services. Management uses a series of local, regional and national indices to develop these estimates. These indices are also used to develop a Municipal Pricing Index (MPI) which is used to forecast total revenue requirements for each year. The 10-Year Financial Plan has costs increasing proportionately to population increase in 2014 and years thereafter.



## READER'S GUIDE

### 2011 Corporate Planning & Budget Review Calendar

Action	Departments & Divisions	Corporate Leadership Team	MSC and Council	Citizens
<b>Strategic Planning</b>				
1. Legal Matters Update (in camera)			May 9	
2. Contractor Strategic Planning Session with Council				
3. Department Action Plans/Performance Planning & Review	March 7			
<b>Budget</b>				
4. Review of the 2011 Corporate Planning and Budget Review Calendar for 2012 - 2014 Budget		May 11	May 24	
5. Review of Draft 10-year Financial Plan		May 13 – 14	June 13	Week of June 13
6. Review and Distribution of Budget Guide to Department Heads	May 13			
7. Overview at MSC on the 2012 Budget as set out in the 2011-2013 Budget Document.			June 13	
8. External consultation with interested stakeholders on the 2012 Budget as set out in the 2011 -2013 Budget Document. Objective to encourage public input for 2012 – 2014 Budget.				Week of June 6
9. Advertise to solicit input from general public for 2012 -2014 Budget				June 3 Advertise July 24 Deadline
10. Input from Council for 2012 – 2014 Budget			July 25	
11. Departments submit O&M and Capital budgets including Capital write ups (word and excel formats)	September 2			
12. <b>First</b> review of 2012 – 2014 O&M Budget by Fund		September 15		
13. <b>First</b> review of 2012 – 2014 Capital Budget including capital write ups		September 16		
14. Departments submit revisions resulting from 1st review of O&M and Capital Budgets	September 21			
15. Departments submit budget highlights, goals & objectives, performance indicators	September 22			
16. Presentation to Council on results of Council input, public input and departmental submissions to 2012 – 2014 Budget – MSC Meeting			October 3	
17. <b>Second</b> review of 2012 – 2014 O&M and Capital Budgets, and budget highlights, goals and objectives and performance indicators (excel and word format)		October 7		
18. Departments submit final revisions of O&M and Capital Budget sections in Publisher format	October 14			
19. <b>Final</b> review of the Budget for 2012 – 2014 (Publisher format)		October 28		
20. Presentation of Budget and Challenges To MSC			November 14	
21. External consultation with interested stakeholders on the draft 2012 - 2014 Budget				November 14
22. Release of the draft 2012 – 2014 Budget to the Public				November 14
23. Council Meeting to hear public presentations on the draft 2012 - 2014 Budget			November 28	November 28
24. Review of draft 2012 – 2014 Budget at Special MSC Meeting			December 5	December 5
25. Adoption of the 2012 – 2014 Budget at Council Meeting			December 12	
<b>Financial Statements (2010 Financial Statements)</b>				
26. Draft Financial Statements	March 4			
27. Review of the Audited Financial Statements		May 16		(cont'd...)

## READER'S GUIDE

### 2011 Corporate Planning & Budget Review Calendar (cont'd)

Action	Departments & Divisions	Corporate Leadership Team	MSC and Council	Citizens
1. Adoption of the Audited Financial Statements by Audit Committee			May 18	
2. Adoption of the Audited Financial Statements			May 24 – MSC June 13 – Council	
3. Preparation of the Draft Annual Report		May 18		
4. Distribution of the Annual Report		June 30		
<b>Board of Revision</b>				
5. Assessment Appeal Deadline				February 21
6. Appeal Hearings				April 7 & 8
<b>Variance Reports</b>				
7. Preparation of O&M and Capital Variance Reports		July 20 October 12		
8. Review of O&M and Capital Variance Reports by Audit Committee			July 27 October 19	
9. Distribution of O&M and Capital Progress/Variance Reports			August 2 October 24	



## BUDGET POLICIES

---

### GFOA

#### 1. Recommended Budget Policies

Purpose: To establish a guide for budgeting practices.

Policy: The recommended budget practices of the Government Finance Officers Association (GFOA) shall be used as a guide for the City budget practices. The budget shall report if the City has instituted or plans to institute each practice.

Adopted: September 25, 2000/Implemented November 2000

### COMMUNITY ASSESSMENT

#### 2. Stakeholder Concerns

Purpose: To direct the limited resources of the City in a manner consistent with the concerns, needs and priorities of stakeholders of the City.

Policy: The City shall take the steps necessary to identify the top concerns, needs and priorities of stakeholders. The concerns and needs shall be determined by research including interviews, meetings, surveys, public submissions and other mechanisms.

Adopted: September 25, 2000/Implemented April 2001

#### 3. Community Profile

Purpose: To ensure the City adequately understands the issues and trends affecting the community so that Council can establish the most appropriate goals.

Policy: The City shall prepare annually a report of issues and trends as a basis for formulating Council goals. Council shall ensure that the report is reasonable, complete and included in the budget.

Adopted: September 25, 2000/Implemented April 2001

### INTERNAL ASSESSMENT

#### 4. Program Assessments

Purpose: To identify and assess programs provided by the City, their intended purpose, and factors that could affect their provision in the future.

Policy: For each City program, the budget shall describe the purpose, beneficiaries and needs served, success in achieving goals, and the issues, challenges and opportunities affecting their provision in the future. The City shall establish a five-year schedule to review specific programs as identified by Council.

Adopted: September 25, 2000/Implemented April 2001

#### 5. Capital Asset Assessment

Purpose: To identify and assess the City's capital assets, including the condition of the assets and factors that could affect the need for or ability to maintain the assets in the future.

Policy: Council shall establish standards for the acceptable condition of capital assets.

An inventory of capital assets shall be maintained that describes the condition of the assets, deferred maintenance and needed improvements.

Management shall report on the need for and condition of the capital assets. The report shall discuss community needs and priorities, deferred maintenance, funding issues, changes in technology and other factors considered relevant. Council shall ensure that the report is reasonable, complete and included in the budget.

Adopted: September 25, 2000/Implemented April 2001

## BUDGET POLICIES

---

### 6. Management Systems Assessment

**Purpose:** To identify and analyze the City's organization and management systems, including system strengths and weaknesses and factors that could affect these systems in the future.

**Policy:** The City shall prepare annually a report of the City organization and management system. The City shall establish a five-year schedule to review specific aspects of the City organization and management system as identified by Council.

**Adopted:** September 25, 2000/Implemented April 2001

Council shall ensure that budget goals are widely disseminated and reviewed with stakeholders on an ongoing basis.

**Adopted:** September 25, 2000/Implemented May 2001

## BUDGET GOALS

### 7. Council's Budget Goals

**Purpose:** To define the priorities and preferred future state of the community as a basis for making resource allocation decisions during the budget process.

**Policy:** Council shall adopt three-year budget goals at the start of each Council term and review budget goals annually.

Council shall adopt budget goals that:

1. reflect stakeholder concerns, needs and priorities;
2. reflect the community's economic, social and environmental conditions, challenges and opportunities;
3. are sufficiently specific to help define the programs to be emphasized and make difficult resource allocation decisions in the budget process; and
4. are prioritized.

## FINANCIAL POLICIES

### 8. Stabilization Funds

**Purpose:** To maintain an adequate level of financial resources to protect against reducing service levels or raising taxes and fees because of temporary revenue shortfalls or unpredicted one-time expenditures.

**Policy:** Council shall establish and maintain fund balances as follows:

1. General Fund, Solid Waste Management Fund and Water & Sewer Fund: no less than 10% and no more than 15% of budgeted expenditures;
2. Land Development Fund: no less than nil;
3. Service Connection Failure Assistance Fund: no less than nil;
4. Capital Fund: no less than nil; and
5. Reserve Fund: amounts sufficient to fund expenditures in accordance with the Capital Improvement Plan

Fund balances may be used at Council's discretion for emergencies, unanticipated economic downturns, and one-time opportunities. If feasible, minimum fund balances shall be restored in the following year and, certainly, within five years of use.



## BUDGET POLICIES

---

The budget shall include a five-year plan to attain minimum fund balances by December 31, 2008 and thereafter maintain minimum fund balances.

Adopted: June 27, 2005

### 9. Fees and Charges

Purpose: To identify the Cost of Service and portion of costs recovered from fees for each program.

Policy: To allow for a better understanding of the Cost of Service and to consider the appropriateness of established fees.

The budget shall identify:

1. the Cost of Service and the amount recovered from fees for each program; and
2. the policy for each program regarding the recovery of Cost of Service.

Fees shall be established to recover 100% of Cost of Service unless Council clearly sets fees using a different basis.

Fees required to recover Cost of Service may be reduced by government transfers allocated to the program.

Adopted: September 25, 2000/Implemented November 2001

### 10. Debt Issuance and Management

Purpose: To ensure that debt is issued and managed prudently in order to maintain a sound fiscal position.

Policy Long-term debt may be issued to finance capital acquisitions, finance land development and refinance existing long-term debt. Long-term debt may not be issued to finance operating costs.

The maximum term of any debt, except debt for land development, shall be the useful life of the asset to a maximum of 25 years. The maximum term for debt for land development shall be 10 years.

Debt limits shall be as follows:

1. the total amount of outstanding debt shall not exceed 5% of the total current assessed value of all property in which taxes or grants are paid;
2. temporary borrowing shall not exceed \$10 million; and
3. total annual debt servicing costs shall not exceed 10% of the net amount of total revenue less government transfers. Grants-in-lieu of taxes shall not be considered government transfers.

All new debt issued, including temporary borrowing, long-term borrowing, capital leases and other forms of debt, shall be approved by by-law and issued in accordance with the standard purchasing policies of the City.

Debt to be repaid using collections of unpredictable revenue, such as land sales, shall be supported by a cash flow projection that demonstrates that collections of unpredictable revenue will be sufficient to make principal and interest payments.

## BUDGET POLICIES

---

The projection shall be prepared in accordance with GAAP and use assumptions that reflect the most probable set of economic conditions and planned courses of action. The projection shall use conservative estimates and, as much as possible, be supported by and reference third party analysis and information.

The importance of matching the timing of debt proceeds to expenditures and of debt-servicing to revenue shall be considered less important than the ability to service the debt and minimize the net present value of cash flows. The factors to be used to determine the date of issue and the structure of debt are:

1. the future availability of cash to service the debt; and
2. minimizing the net present value of all cash flows affected by financing, including interest revenue, temporary borrowing and all long-term debt.

The City may issue debt in the fiscal year immediately subsequent to the fiscal year in which the capital asset is acquired, if the financial benefit is clearly demonstrated.

The budget shall include a plan to comply with the prescribed debt limits by December 31, 2005 and thereafter maintain the prescribed debt limits.

Adopted: September 25, 2000/Implemented November 2001

### 11. Debt Level and Capacity

Purpose: To ensure that outstanding and planned debt levels do not exceed an amount that can be supported by the existing and projected tax and revenue base.

Policy: The budget shall include an analysis of debt capacity with the following information:

1. statutory limitations;
2. evaluation of trends in the City's financial performance including availability and reliability of net revenues expected to service debt;
3. disclosure of five-year projections of measures relevant to determining debt capacity.

The budget shall include an analysis of capital improvement options using the following financing alternatives:

1. debt as required by capital improvement plans;
2. maximum allowed levels of outstanding debt and annual debt-servicing; and
3. no new debt.

Adopted: September 25, 2000/Implemented November 2001

### 12. One-Time Revenues

Purpose: To limit the use of one-time revenues for ongoing expenditures.

Policy: One-time revenues and their use shall be clearly identified in the budget. One-time revenues shall include amounts exceeding \$50,000 from infrequent sale of capital assets, infrequent revenue from land development and non-recurring grants. One-time revenues may be available for more than one year, but are expected to be non-recurring.



## BUDGET POLICIES

---

One-time revenues may be used only to increase fund balances, decrease debt or for non-recurring expenditures such as capital acquisitions, one-time projects, and grants. The budget shall disclose estimated future operating costs and commitments, if any, from non-recurring expenditures.

Adopted: September 25, 2000/Implemented November, 2001

### 13. Unpredictable Revenues

**Purpose:** To consider how significant variation in revenue will affect the City's financial outlook and ability to operate programs in the current and future budget periods.

**Policy:** The budget shall identify each unpredictable revenue source. Unpredictable revenue sources are those revenues with a more than normal risk of varying from budget by more than \$50,000. The collection of revenue shall be considered when determining whether revenue is unpredictable.

The budget amount for each unpredictable revenue source shall be the City's best estimate at the time of the budget. The budget shall include a range of possible revenue amounts including a conservative estimate and optimistic estimate.

For each unpredictable revenue source, the budget shall identify those aspects of the revenue source that makes the revenue unpredictable. Most importantly, the budget shall identify the expected or normal degree of volatility of the revenue source.

Council shall set out in the budget a set of tentative actions to be taken if one or more sources generate revenues substantially higher or lower than projected.

Adopted: September 25, 2000/Implemented November, 2001

### 14. Balancing the Budget

**Purpose:** To balance the budget under normal circumstances and provide for disclosure when a deviation from a balanced budget occurs.

**Policy:** The budget shall be balanced except when reasonably unforeseeable circumstances occur. Examples of unforeseeable circumstances include sudden and severe fluctuations in revenue, major emergency expenditures and significant changes in the value of assets.

The budget shall be considered balanced if:

1. fund balances are within the minimum and maximum limits prescribed in the policy on Stabilization Funds; or
2. the change in balance of each fund meets or exceeds the plan to establish minimum fund balances as prescribed in the policy on Stabilization Funds.

The budget shall disclose whether the budget is balanced. If the budget is not balanced, the budget shall disclose the reasons for not balancing the budget.

The change in balance of each fund shall be determined in accordance with generally accepted accounting principles for local governments and the Financial Administration By-law.

Adopted: September 25, 2000/Implemented November, 2001

### 15. Revenue Diversification

**Purpose:** To ensure the City has diverse revenue sources.

**Policy:** The City shall identify existing potential sources of revenue greater than \$100,000 and consider options to enhance the diversity of revenue sources.



## BUDGET POLICIES

---

The City shall examine sources of revenue to determine:

1. the sensitivity of the amount of revenue to changes in rates;
2. the fairness of the tax or fee; and
3. administrative aspects of the revenue source.

Adopted: September 25, 2000/Implemented November, 2001

### 16. Contingency Planning

Purpose: To establish a financial plan to assist the City to take timely action and aid in the overall management of emergencies and unexpected events.

Policy: The budget shall disclose the amount, sources and availability of funds that could be directed to the costs of emergencies, natural disasters or other unexpected events.

The budget shall disclose a general financial plan to restore the financial position of the City.

Adopted: September 25, 2000/Implemented November, 2001

## POLICIES AND PLANS

### 17. Program Design

Purpose: To guide program design by developing and adopting policies and plans necessary to implement Budget Goals.

Policy: Council shall provide direction on how to achieve Budget Goals by adopting City-wide policies and plans to guide the design of specific programs.

The policies and plans shall be sufficiently specific to provide adequate guidance for programs design.

The policies and plans shall consider the assessment of the community, the internal assessment, Council's Budget Goals, and the financial policies.

The policies and plans shall include service delivery issues, performance standards, time frames from achievement of goals and other guidance considered beneficial to design programs.

Adopted: September 25, 2000/Implemented November, 2001

### 18. Capital Asset Management

Purpose: To guide capital asset management by adopting policies and plans for capital asset acquisition, maintenance, replacement and retirement.

Policy: Council shall consider the Capital Assets Assessment and Council's Budget Goals when adopting policies on capital asset management.

Council shall adopt annually five- and twenty-year capital improvement plans. Council shall consider whether the planned level of capital expenditures is adequate to maintain the standards set for capital assets. Council shall not unduly defer capital expenditures.

Council shall provide adequate Capital fund revenue by including, at least:

1. All block funding, except block funding allocated to the Land Development Fund. Block funding shall not be allocated or transferred to the General Fund, the Water & Sewer Fund or the Solid Waste Management Fund;



## BUDGET POLICIES

---

2. Equal to the greater of
  - a) All municipal taxes from mining that are collected or considered collectable, plus 10% of non-mining taxation revenue. Non-mining taxation revenues equals non-mining municipal taxes, net of discounts and exemptions, plus all grants-in-lieu; or
  - b) Debt-Servicing Costs on long-term debt (excluding land-related debt-servicing costs)
3. 30% of water and sewer revenue;
4. 10% of solid waste management revenue; and
5. Local improvement charges.

Infrastructure and land not for resale shall be funded by capital revenue and/or debt, and not by reserves. Capital assets other than infrastructure and land not for resale shall be funded by reserves.

The City shall set aside in reserves the amount necessary to replace capital assets:

1. if the life of the asset is no more than 20 years, over the remaining life of the asset; or
2. if the life of the asset is more than 20 years, over the last 20 years of the life of the asset or the remaining life of the asset, if less.

The City shall set aside in reserves the amount necessary to acquire new capital assets over the period available once Council approves the plan to acquire the new asset.

Adopted: June 27, 2005

### 19. Budget Type, Presentation and Time Period of the Budget

**Purpose:** The type of budget, time period covered and the manner of presenting materials in the budget document have a significant practical impact on the City's approach to planning, control and overall management of its programs, services, and finances and on the quality of information provided to stakeholders.

**Policy:** The *Cities, Towns and Villages Act* states that an annual budget must be adopted by Council prior to the end of the fiscal year; therefore the City of Yellowknife will prepare a three-year rolling budget document which meets the criteria of the GFOA's Budget Presentation Award Program on the basis of program/line item combination (which is currently being used) and the second- and third-year budgets shall be adopted in principle in the first year and then adopted individually each year thereafter.

Adopted: June 25, 2001

### 20. Amending the Budget

**Purpose:** The City recognizes that many factors, extraordinary or not, such as changes in Council's goals and objectives, collective bargaining agreements, performance measurements and economic stability, may impact the City's financial position on an annual basis.

**Policy:** Prior to City Council adopting the second- and third-year budgets, Administration will prepare a summary of significant changes and events that have occurred which may impact on second- and third-year budgets and will provide proposed revisions to the adopted budget in principle.

Adopted: June 25, 2001

## BUDGET POLICIES

---

### 21. Performance Measures – Financial Condition

Purpose: To monitor and evaluate the financial condition of the City.

Policy: The financial health of the City is critical to its ability to meet the needs of its stakeholders.

Financial condition should be evaluated to identify potential problems and any changes that may be needed to improve performance over both the short and long terms.

Financial indicator measures are developed to monitor financial conditions and achievement of explicitly set financial goals.

Adopted: March 24, 2003

### 22. Performance Measures – Capital Program Implementation

Purpose: To monitor, measure and evaluate capital program implementation.

Policy: The status of significant capital projects will be monitored to ensure progress as planned, problems (such as delays in key milestones and cost overruns) are identified early enough to take corrective action, funds are available when needed, and legal requirements are met.

Adopted: March 24, 2003

### 23. Performance Measures – Budgetary Performance

Purpose: To guide program design by developing and adopting policies and plans necessary to implement budget goals.

Policy: Regular monitoring of budgetary performance provides an early warning of potential problems and

gives decision makers time to consider actions that may be needed if major deviations in budget-to-actual results become evident. It is also an essential input in demonstrating accountability.

Budget-to-actual or budget-to-projected actual comparisons of revenues, expenditures, cash flows, and fund balances should be reviewed periodically during the budget period year. Staffing levels should also be monitored. Comparisons for, at minimum, the current year should be included in the budget document and be generally available to stakeholders during discussions related to budget preparation and adoption.

Adopted: March 24, 2003

### 24. Performance Measures – External Factors

Purpose: To monitor, measure and evaluate external factors that may affect budget and financial performance, and achievement of goals.

Policy: Factors outside the City's control such as the national or territorial economy, demographic changes, statutory changes, mandates, and weather may affect achievement of stated goals. Monitoring these factors helps the City evaluate and respond to the effect of these external influences on goals, programs and financial plans.

External factors likely to impact achievement of goals should be identified and monitored regularly. Results of the analysis should be factored into the assessment of program and financial performance, and considered when making adjustments to these programs. Trends and significant issues may be described in reports to stakeholders discussing program, budget, and financial performance.



## BUDGET POLICIES

---

An assessment of external factors will be reported on in summary form and available to stakeholders. The Economic Outlook report should include, but not be limited to: population projections, employment statistics, Consumer Price Index, new construction values, housing starts, and Gross Domestic Product.

Adopted: March 24, 2003

### 25. Performance Measures – Stakeholder Satisfaction

**Purpose:** To monitor and evaluate stakeholder satisfaction with programs and services.

**Policy:** The main contact with a government for many stakeholders is through the programs and services it provides. It is important for the City to be aware of and respond to stakeholder perceptions of these programs and services. Stakeholder perceptions of the quality of public services is an important factor in their overall perception of the City and their level of confidence in the City's decision-making.

The City will use a variety of ways to access stakeholder satisfaction, including public forums or hearings, focus groups, and surveys. At least biennially, the City will conduct a Citizen Survey which formally assesses satisfaction with programs and services. The Citizen Survey, and any other source or input, will be reported upon using the appropriate technology, and be available to all stakeholders.

Adopted: March 24, 2003

### 26. Performance Measures – Program Performance

**Purpose:** To monitor, measure, and evaluate the performance of programs and services the City provides.

**Policy:** Government functions, programs, and activities should be periodically reviewed to determine whether they are accomplishing the intended goals and objectives.

Performance measures, including efficiency and effectiveness measures, should be presented in basic budget material, including the operating budget document, and should be available to stakeholders. Performance measures should be reported using actual data, where possible. At least some of the measures should document progress toward achievement of previously developed goals and objectives. More formal reviews, and documentation of these reviews, should be carried out as part of the overall planning, decision-making and budget process.

Adopted: March 24, 2004

### 27. Administration Fees

**Purpose:** To set administration fees for interfund transfers to the General Fund.

**Policy:** Council shall transfer to the General Fund an administration fee of:

1. 15% of revenue from the Water and Sewer Fund;
2. 10% of revenue from the Solid Waste Management Fund;
3. a minimum of \$100,000 from the Land Development Fund, subject to achieving the minimum fund balances set out in the Stabilization Funds policy.

Adopted: June 27, 2005

**THIS PAGE LEFT BLANK INTENTIONALLY**



## COMMUNITY PROFILE

---

### City Council

Mayor Gordon Van Tighem  
Councillor Lydia Bardak  
Councillor Bob Brooks  
Councillor Paul Falvo  
Councillor Mark Heyck  
Councillor Amanda Mallon  
Councillor Shelagh Montgomery  
Councillor Cory Vanthuyne  
Councillor David Wind

### City Administration

City Administrator	Bob Long
Director of Corporate Services	Carl Bird
Director of Economic Development	Peter Neugebauer
Director of Public Works & Engineering	Dennis Kefalas
Director of Community Services	Grant White
Director of Public Safety	Dennis Marchiori
Director of Planning & Development	Jeffrey Humble

### City Auditors

MacKay LLP

### City Bankers

TD Canada Trust

### City Solicitors

McLennan Ross LLP

## COMMUNITY PROFILE

---

### Yellowknife - Small City - Big Sizzle!

From the world's longest ice roads and the glorious midnight sun to the most spectacular display of northern lights on the planet, Yellowknife is the perfect year-round outdoor playground. We are located on the shores of beautiful Great Slave Lake, only 512 km south of the Arctic Circle and 966 air miles north of Edmonton. We are world-renowned for our outdoor recreation, midnight sun, aurora borealis and our unusual blend of northern culture.

We have a comprehensive education system. We offer an extensive range of sports and recreation activities and facilities. We have over 120 sport, service and cultural associations. We offer excellent services for our senior citizens. But, our most valued amenity is our very vibrant community spirit which proudly characterizes Yellowknife!

In addition to our natural attributes and sense of community, we are equally proud of our commitment to economic diversification.

Built on gold, nurtured by government and growing with diamonds, Yellowknife offers unrivalled opportunities for investment, tourism, business development and employment. The abundance of minerals, oil and gas in the NWT has had dramatic economic impacts on Yellowknife. Along with being the capital city, Yellowknife is the territorial mining, industry, transportation, communications, education, health, tourism, commerce, government, wholesale, service and trade centre for Canada's North. Of all northern supply centres in Western Canada, Yellowknife has the highest employment, highest level of income, most skilled population and the most cosmopolitan workforce.

Our city, which became a municipal district in 1953, is governed through legislative acts and regulations of the Government of the Northwest Territories. The Northwest Territories is one of only two federal, provincial and territorial jurisdictions in Canada that operate under a consensus system of government, as opposed to the more familiar system of party politics. Members of the Legislative Assembly are elected as independents within their constituencies. Territorial elections are held every four years, with the next election to be held in October, 2011. Our City Council is comprised of the Mayor and eight Councillors, with elections held every three years. The next municipal election will be held on October 15, 2012.

2010 marked our 40<sup>th</sup> Anniversary of incorporation as a City on January 1, 1970. Since that time, we have adopted the "knife" icon to acknowledge gold mining as the City's foundation. The knife replicates a copper powder knife used by the suppliers of dynamite to the mining industry to open powder cases as steel knives could cause sparks.

Our golden history and brilliant future are also signified by the Government of the Northwest Territories' official symbols of "Gold" as our official mineral, and "Diamond" as our official gemstone.



## COMMUNITY PROFILE

---

### Our Economy

In the Tlicho aboriginal language, Yellowknife is Somba K'e, or 'place of money', and the name rings remarkably true. For many years, Yellowknife was home to two gold mines, Con and Giant. Today, it's the centre of Canada's diamond industry and remains the gateway to the entire North.

Yellowknife's current thriving economy is largely a result of the exploration and development of the NWT's natural resources, including diamonds, uranium, rare earth metals, and oil and gas. Yellowknife is also the starting point for wilderness adventure and aurora viewing, along with being a centre for aboriginal arts and crafts.

The NWT has three operating diamond mines, and one currently in development stages. These mines are located about 250 kilometres northeast of Yellowknife, in the Lac de Gras region. The **Ekati Mine** was the first diamond mine in the NWT and Canada, and is the result of the largest staking rush in Canadian history. Production began at the mine in 1998. **Diavik Diamond Mine**, our second diamond mine, began production in 2003. The **Snap Lake Mine** began operations in 2008 and is the NWT's third diamond mine. It is the first entirely underground diamond mine in the country.

The proposed Gahcho Kué mine, located 280 kilometres northeast of Yellowknife, is a joint venture between De Beers Canada (51%) and Mountain Province Diamonds (49%). The project is currently undergoing an environmental impact review, expected to be complete by mid-2013. Once approved, it will take about two years to build the mine. Over an 11-year mine life, about 4.5 million carats of diamonds will be produced annually. At full production the workforce is predicted to be about 370 people.

The collective operation of the Ekati, Diavik and Snap Lake diamond mines produce 15% of the world's gemstone diamonds. Diamond production for 2010 reached 11 million carats worth approximately \$2 billion. Canada is the third largest diamond producer by value in the world, after Botswana and Russia.

Since 1996, the Northwest Territories' diamond mines have provided over 31,000 person-years of employment and have surpassed \$11 billion in investment with northern and aboriginal businesses.

### Tourism

Tourism is the largest renewable resource-based industry in the NWT, and the majority of visitors to the territory touch down in Yellowknife. Tourism pumps more money into the territorial economy than combined sales of agriculture, forestry, fishing and trapping. In 2009/10, over 68,000 tourists visited the Northwest Territories and spent more than \$107 million.



Yellowknife is also a key conference and meeting destination. The City has the facilities, catering, fine dining, accommodation, event planners, tourist attractions, and technological capabilities to host large and small events. In the past several years, Yellowknife has hosted events for up to 2,000 participants. The International Congress on Circumpolar Health brought medical scientists, health care specialists, health administrators, and indigenous peoples of the Far North together

with approximately 600 delegates from across the circumpolar world. Yellowknife is also host to the annual Geoscience Forum. This conference provides an intimate setting for the exchange of information on mineral and petroleum exploration, mining activities, and government and academia geoscience research in Canada's North. The 2010 Yellowknife Geoscience Forum attracted approximately 800 delegates from industry, academia, and government.



## COMMUNITY PROFILE

---

### Deh Cho Bridge

The Government of the Northwest Territories is building a cablestay bridge to span the Mackenzie River near Fort Providence. The bridge will replace the operations of the Merv Hardie ferry and the Mackenzie River ice crossing currently at that location.

### Trades and Services

This sector has experienced growth the last few years in Yellowknife and across the NWT, mainly due to non-renewable resource activity and higher personal incomes. Yellowknife has four malls, a good variety of national chain stores, and a number of local shops to meet the shopping needs of residents and visitors.

The wealth of an economy, as well as the market for service and retail businesses, is reflected in personal incomes. According to recent Statistics Canada reports, the NWT had the highest personal incomes of any jurisdiction in Canada. The average weekly income was \$1,081.27, with the next highest being Alberta at \$923.41, then Nunavut at \$908.37.

Another sign of a prosperous population is its youth. In a dynamic environment with lots of opportunity, youth are able to secure challenging, highly paid, employment at home. In other regions and communities without opportunity, they leave for “greener” pastures.

Our population is the highest educated of any northern city in Western Canada. This provides employers with a highly educated pool of potential employees.

### An “Eco-Friendly” Community that Walks or Bikes to Work

While Yellowknife is a major trading centre, it is also a relatively compact city. The City has by far the highest proportion of people walking or biking to work of any other northern Canadian city, with almost 16% of our population walking to work.

Although the winters may reach lows of  $-40^{\circ}$  to  $-50^{\circ}$  Celsius, the walking distance for individuals is minimal as the City is quite centralized. Beautiful trails and walkways outline the many lakes in the area, making for a picturesque view. All offices provide bike facilities for lock up, and the streets of Yellowknife are biker-friendly.

The City of Yellowknife has been named Most Sustainable Small-Sized City in Canada by *Corporate Knights*, a Canadian magazine for responsible business. The City was recognized for its move to integrate energy efficiency into its building codes, its high population density, its high ratio of homeless shelter beds to population, and an annual arts competition as factors that make it sustainable.

Yellowknife, Diamond Capital of North America™ is truly a City of energy and excitement, where our doors are always open to opportunity!



## COMMUNITY PROFILE

### YELLOWKNIFE - STATISTICAL PROFILE

#### Largest Private Municipal & School Property Taxpayers for 2011

	2010 (\$000s)	2011 (\$000s)	Percent Of 2011 Total
Northern Property REIT & Urbco Inc.	\$1,909	\$2,137	6.79%
Dundeal Canada West (GP) Inc.	\$931	\$959	3.05%
RTL Robinson Enterprises Ltd. and Robinson Trucking Ltd.	\$677	\$692	2.20%
Polar Developments Ltd. & 5119 NWT Ltd.	\$570	\$514	1.63%
Northwestel Inc.	\$372	\$397	1.26%
4912 NWT Ltd. o/a Explorer Hotel	\$313	\$323	1.03%
HREIT Holdings 18 Corp. & 32 Corp.	\$317	\$306	0.97%
Gold Bar Development & Andromeda Investment Ltd.	\$298	\$279	0.89%
Royal Host GP Inc. (Yellowknife Inn)	\$207	\$213	0.68%
NWT Community Services Corp	\$201	\$207	0.66%

Top Employers	2001 (FTEs)	2002 (FTEs)	2003 (FTEs)	2004 (FTEs)	2005 (FTEs)	2006 (FTEs)	2007 (FTEs)	2008 (FTEs)	2009 (FTEs)	2010 (FTEs)	2011 (FTEs)	Notes
Government of the NWT	2,226	2,286	2,409	2,253	2,256	2,372	2,399	2,390	2,341	2,366	2,442	(1)
Government of Canada	642	745	756	665	770	716	809	766	725	738	804	(2)
BHP Billiton Diamonds	329	340	400	356	337	307	318	280	300	322	325	
Diavik Diamond Mines Inc.	-	-	288	327	317	317	315	368	223	231	278	(3)
RTL Robinson Enterprises Ltd.	124	254	213	165	250	250	250	260	234	243	247	
YK Education District No. 1	218	225	225	225	229	221	230	230	226	234	233	
First Air	260	234	210	210	195	198	197	226	184	218	204	
City of Yellowknife	146	150	157	161	163	166	168	176	181	186	187	
Yellowknife Catholic Schools	153	182	182	167	170	173	175	164	157	163	169	
Northwestel	179	175	173	172	174	175	186	174	170	167	155	

#### Notes:

Amounts based on actual number of FTEs as of September 1, 2011 unless otherwise noted.

- (1) Per GNWT Main Estimates.
- (2) Includes all departments of the federal government, Crown corporations, Canadian Forces and the RCMP.
- (3) 2001 and 2002 numbers not available.

# COMMUNITY PROFILE

Population by Age Group

Age Group	2004	Percent	2005	Percent	2006	Percent	2007	Percent	2008	Percent	2009	Percent	2010	Percent
0-4 Years	1,436	7.46%	1,495	7.80%	1,474	7.88%	1,463	7.64%	1,495	7.76%	1,544	7.83%	1,579	7.92%
5-9 Years	1,528	7.93%	1,461	7.62%	1,354	7.24%	1,365	7.13%	1,253	6.51%	1,224	6.21%	1,332	6.68%
10-14 Years	1,512	7.85%	1,516	7.91%	1,514	8.10%	1,494	7.80%	1,319	6.85%	1,176	5.97%	1,116	5.60%
15-24 Years	3,106	16.13%	3,057	15.95%	2,900	15.51%	2,932	15.31%	3,088	16.04%	3,138	15.92%	3,160	15.86%
25-44 Years	7,109	36.91%	6,993	36.48%	6,757	36.14%	6,847	35.75%	6,694	34.76%	6,937	35.19%	6,914	34.70%
45-59 Years	3,675	19.08%	3,703	19.32%	3,685	19.71%	3,870	20.20%	4,313	22.40%	4,437	22.51%	4,430	22.23%
60 Years & Older	892	4.63%	943	4.92%	1,011	5.41%	1,184	6.18%	1,094	5.68%	1,255	6.37%	1,396	7.01%
	<u>19,258</u>		<u>19,168</u>		<u>18,695</u>		<u>19,155</u>		<u>19,256</u>		<u>19,711</u>		<u>19,927</u>	

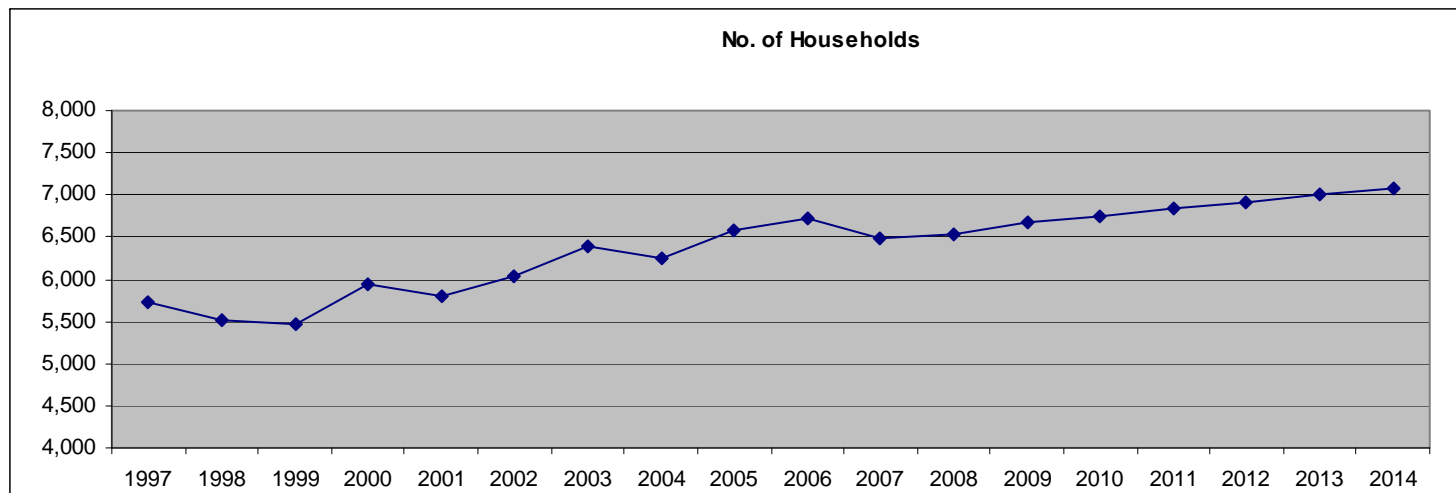
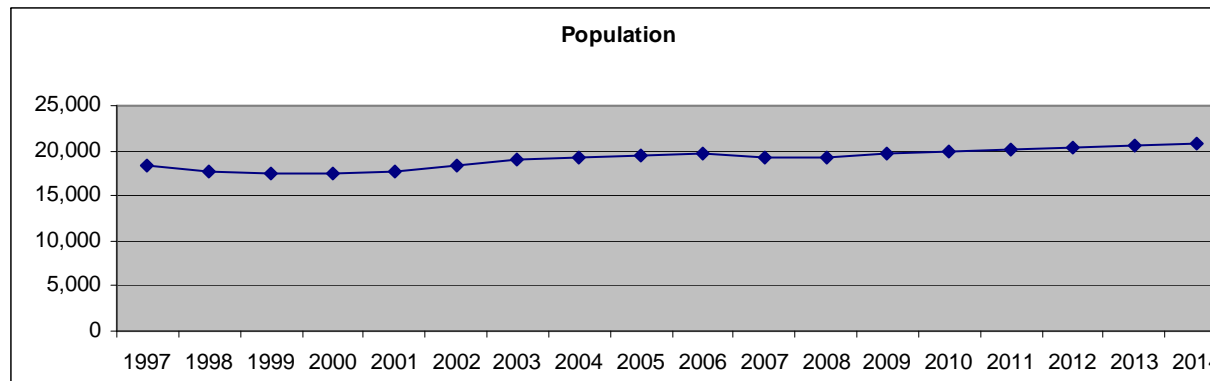

## COMMUNITY PROFILE

### Education

Percent with High School or Post - Secondary

	Yellowknife	Canada
1991	73.9	61.8
1994	79.0	
1996	75.3	65.2
1999	80.6	
2001	77.7	68.7
2004	82.1	
2006	81.0	76.2
2009	83.8	

### Average Personal Income (\$ per annum)

	Yellowknife	Canada
2000	42,993	30,594
2001	45,975	31,692
2002	50,038	32,306
2003	50,345	33,117
2004	52,061	34,366
2005	54,679	35,909
2006	57,246	37,776
2007	59,589	39,607
2008	62,727	40,672
2009	62,711	40,301

### Average Family Income (\$ per annum)

	Yellowknife	Canada
2000	88,295	64,618
2001	97,377	68,250
2002	106,953	69,683
2003	107,534	71,016
2004	111,665	73,961
2005	117,023	77,664
2006	124,200	82,307
2007	128,473	86,219
2008	135,800	88,718
2009	134,645	87,671

### Unemployment Rate

	Yellowknife	Canada
1991	5.1	10.2
1994	6.8	
1996	6.4	10.1
1999	7.9	
2001	5.0	7.4
2004	5.0	
2006	5.7	6.6
2009	5.6	

### All Items Inflation Rate (%)

	Yellowknife	Canada
1997	0.1	1.7
1998	-0.1	1.0
1999	1.1	1.8
2000	1.7	2.7
2001	1.6	2.5
2002	3.0	2.2
2003	2.3	2.8
2004	1.5	1.8
2005	2.3	2.2
2006	1.4	2.0
2007	2.9	2.2
2008	4.0	2.3
2009	0.6	0.3
2010	1.7	1.8

Source: Statistics Canada



## COUNCIL'S GOALS

---

### Yellowknife City Council



Mayor Gordon Van Tighem

Lydia Bardak



Paul Falvo



Amanda Mallon



Cory Vanthuyne



Bob Brooks



Mark Heyck



Shelagh Montgomery



David Wind

City Council adopted the following Goals and Objectives at its meeting on November 22, 2010:

#### Community Vision:

A welcoming, inclusive, vibrant and family-oriented City with a strong sense of community pride and volunteerism. We will strive to be self-sufficient leaders in business and education, while actively promoting and protecting our unique history, culture and natural beauty.

#### Council Mission:

Council will provide leadership, vision and direction in responding to the needs and aspirations of the community. To meet those needs and aspirations, Council will work co-operatively with staff and residents to provide municipal infrastructure, programs and services that are fiscally responsible and sustainable.

#### Corporate Vision:

To be the most inclusive, progressive and well-managed community in Canada.

## COUNCIL'S GOALS

---

### **Goal # 1**      **Affordability**

#### **Objectives:**

- 1.1 Realize opportunities to encourage economic growth and diversity.
- 1.2 Adopt a sustainable and practical approach to infrastructure deficit reduction.
- 1.3 Pursue creative market partnerships to promote affordable living.
- 1.4 Emphasize fairness and transparency in financial decisions, program delivery and land assembly.

#### **Actions:**

- 1(a) Establish a Community Affordability Task Force.
- 1(b) Review the City's land development policies.
- 1(c) Develop an implementation plan for housing supply options and partnerships.
- 1(d) Develop opportunities for joint ventures with other orders of government and the private sector to meet the affordability goal.

### **Goal # 2**      **Enhancing Our Built Environment**

#### **Objectives:**

- 2.1 Maintain, respect, preserve and enhance the natural environment, natural heritage and green space.
- 2.2 Improve transit, roads, sidewalks, recreation facilities and trails with an emphasis on active transportation.
- 2.3 Develop smart and sustainable approaches to energy, water and sewer, waste management, and building systems.
- 2.4 Promote a range of commercial, residential, and institutional development and revitalization opportunities.

#### **Actions:**

- 2(a) Address the infrastructure deficit.
- 2(b) Develop a plan for the Capital area.
- 2(c) Develop an implementation plan for district energy.
- 2(d) Complete and implement a Harbour Plan.
- 2(e) Develop an implementation plan for downtown revitalization.

### **Goal # 3**      **Building Social Capital (Community Engagement)**

#### **Objectives:**

- 3.1 Develop prosperity through strategic partnerships.
- 3.2 Improve quality of life by promoting healthy and active lifestyle choices.
- 3.3 Improve community participation and volunteerism opportunities.
- 3.4 Promote heritage, culture, arts and other unique characteristics of Yellowknife to honour our past and preserve/showcase our history and cultural diversity.

#### **Actions:**

- 3(a) Build and enhance relationships with First Nations, the private and public sectors.
- 3(b) Develop a communication plan to improve engagement with the community.
- 3(c) Enhance recreational programs and promote Yellowknife as an excellent place to live and play.

### **Goal # 4**      **Continuous Improvement**

#### **Objectives:**

- 4.1 Be accountable to residents by ensuring open and accessible information flow and accessible decision-making.
- 4.2 Create an environment of mutual respect, open dialogue, and teamwork.
- 4.3 Recognize and reward performance.
- 4.4 Be a leader in innovation.

#### **Actions:**

- 4(a) Develop a customer service culture.
- 4(b) Lead in innovation and best practices.
- 4(c) Become a preferred employer.
- 4(d) Develop enhanced accountability measures.
- 4(e) Streamline Council's committee structure.
- 4(f) Enhance marketing of Yellowknife.



## BUDGET SUMMARY

### Summary - All Funds

	2010 Actual (\$000's)	2011 Budget (\$000's)	2011 Forecast (\$000's)	2012 Budget Recommended (\$000's)	2013 Budget (\$000's)	2014 Budget (\$000's)
<b>Revenue</b>						
Taxation (net of transfer)	21,412	22,249	22,309	23,178	24,182	25,013
Government Transfers	11,505	13,730	15,648	13,730	13,730	13,730
User Charges	25,509	21,239	21,570	23,391	23,393	23,941
Investment Income	248	145	162	120	100	100
	<b>58,674</b>	<b>57,363</b>	<b>59,689</b>	<b>60,419</b>	<b>61,405</b>	<b>62,784</b>
<b>Expenditures (By Function)</b>						
General Government	9,874	11,313	11,577	10,245	10,230	10,262
Community Services	15,405	9,083	9,414	9,513	9,355	9,372
Public Safety	5,127	6,517	6,689	5,694	5,897	6,240
Planning & Development	1,781	2,815	3,668	2,647	2,841	3,292
Public Works	9,754	11,982	11,927	10,153	10,757	11,838
Solid Waste Management	3,292	2,354	4,596	2,748	2,826	2,259
Water & Sewer	7,649	18,003	12,014	14,197	13,713	11,087
Land	9,071	1,623	6,979	5,514	4,496	184
Service Connection Failure Assistance	596	574	601	868	1,212	1,213
Amortization	7,936	9,176	9,176	9,192	9,398	9,579
	<b>70,484</b>	<b>73,440</b>	<b>76,641</b>	<b>70,770</b>	<b>70,725</b>	<b>65,327</b>
<b>Net Revenue (Expenditures)</b>	<b>(11,810)</b>	<b>(16,078)</b>	<b>(16,952)</b>	<b>(10,350)</b>	<b>(9,320)</b>	<b>(2,543)</b>
<b>Debt</b>						
<b>Debture Proceeds</b>	-	-	-	-	-	-
<b>Debt Principal Repayments</b>	(706)	(746)	(736)	(649)	(473)	(319)
Change in Fund Balance Before Reallocation of Amortization	(12,516)	(16,824)	(17,688)	(10,999)	(9,793)	(2,862)
Reallocation of Amortization	7,936	9,176	9,176	9,192	9,398	9,579
<b>Change in Fund Balance</b>	<b>(4,580)</b>	<b>(7,648)</b>	<b>(8,512)</b>	<b>(1,808)</b>	<b>(395)</b>	<b>6,717</b>
<b>Opening Balance</b>	<b>11,796</b>	<b>13,411</b>	<b>7,216</b>	<b>(1,297)</b>	<b>(3,104)</b>	<b>(3,498)</b>
<b>Closing Balance</b>	<b>7,216</b>	<b>5,763</b>	<b>(1,297)</b>	<b>(3,105)</b>	<b>(3,499)</b>	<b>3,220</b>

	2010 Actual (\$000's)	2011 Budget (\$000's)	2011 Forecast (\$000's)	2012 Budget Recommended (\$000's)	2013 Budget (\$000's)	2014 Budget (\$000's)
<b>Expenditures (By Object)</b>						
Capital	17,554	26,231	23,305	17,824	16,932	14,522
Contingency	145	75	75	-	-	-
Grants	509	544	529	504	505	507
Interest on Long-Term Debt	191	152	152	144	84	64
Salaries & Benefits	19,518	21,054	20,716	21,535	22,515	23,399
Land	9,071	1,623	6,979	5,514	4,496	184
Operations & Maintenance	15,242	14,485	15,560	15,857	16,595	16,872
Valuation Allowance	318	100	150	200	200	200
Amortization	7,936	9,176	9,176	9,192	9,398	9,579
	<b>70,484</b>	<b>73,440</b>	<b>76,641</b>	<b>70,770</b>	<b>70,725</b>	<b>65,327</b>



## BUDGET SUMMARY

### Fund Balances

	2010 Actual (\$000's)	2011 Budget (\$000's)	2011 Forecast (\$000's)	2012 Budget Recommended (\$000's)	2013 Budget (\$000's)	2014 Budget (\$000's)
<b>Operating Fund Balances</b>						
General Fund	2,077	2,318	2,077	2,079	2,079	2,079
Land Development Fund	(1,342)	2,353	(6,124)	(7,892)	(9,181)	(5,995)
Solid Waste Management Fund	(340)	104	(349)	(358)	(195)	6
Water & Sewer Fund	84	95	84	116	147	162
Service Connection Failure Assistance Fund	-	7	-	-	-	-
	<b>479</b>	<b>4,876</b>	<b>(4,312)</b>	<b>(6,056)</b>	<b>(7,150)</b>	<b>(3,748)</b>
<b>Capital Fund Balance</b>	<b>4,499</b>	<b>-</b>	<b>1,326</b>	<b>45</b>	<b>45</b>	<b>45</b>
<b>Reserve Balances</b>						
Information Technology	784	273	279	266	226	576
Major Community Facility	(919)	(1,000)	(706)	990	1,532	3,762
Mobile Equipment	1,521	980	1,432	1,100	1,340	2,033
Downtown Development	264	105	95	137	180	223
Heritage Committee	48	17	48	48	48	48
Waterfront Development	80	80	80	80	80	80
Twin Pine Hill Trail	260	233	260	85	0	0
Samuel Colley Donation	200	199	200	200	200	200
	<b>2,239</b>	<b>888</b>	<b>1,689</b>	<b>2,907</b>	<b>3,607</b>	<b>6,923</b>
	<b>7,216</b>	<b>5,763</b>	<b>(1,297)</b>	<b>(3,105)</b>	<b>(3,499)</b>	<b>3,220</b>



**2012 BUDGET TOTAL REVENUE (\$60.4 M)**

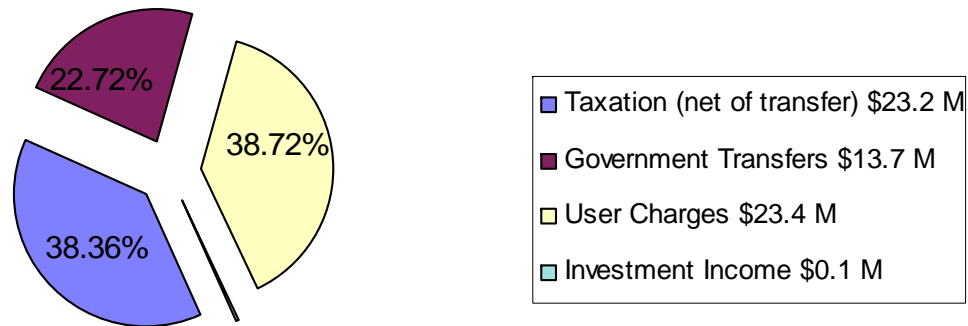

**2012 BUDGET TOTAL EXPENDITURES (\$61.6 M)**

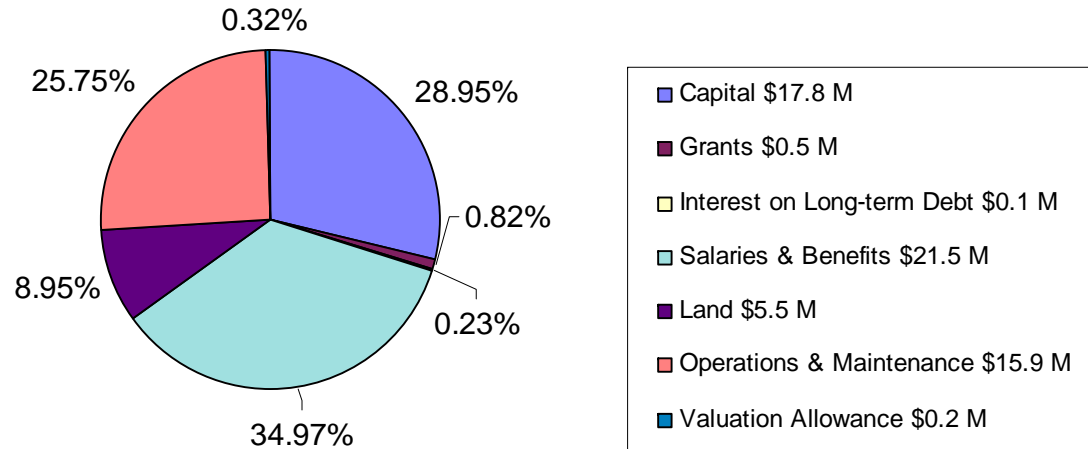

THIS PAGE LEFT BLANK INTENTIONALLY



**STAFFING SUMMARY**

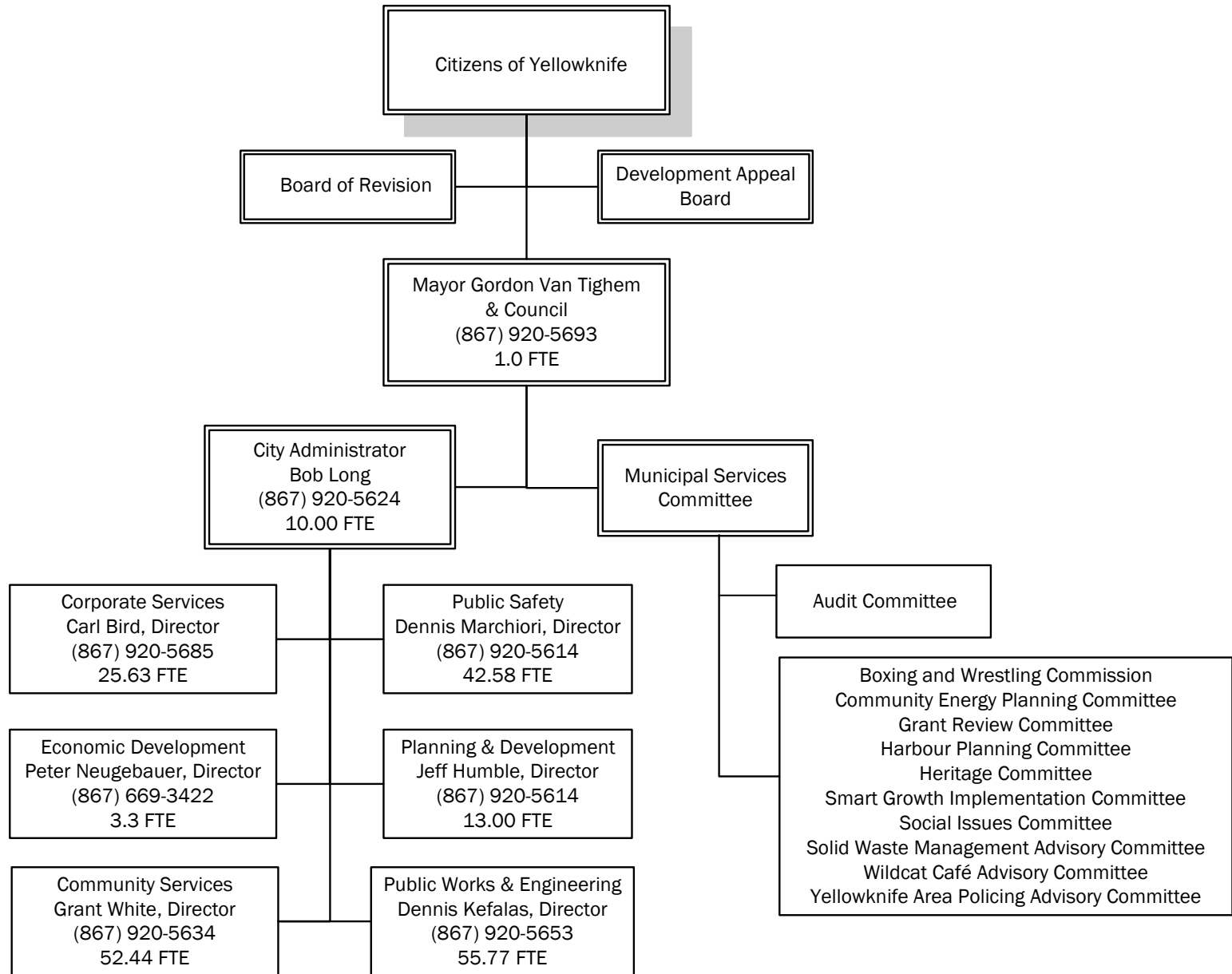

## STAFFING SUMMARY

Staffing By Department: (FTE)	2001 Actual	2002 Actual	2003 Actual	2004 Actual	2005 Actual	2006 Actual	2007 Actual	2008 Actual	2009 Actual	2010 Actual	2011 Actual	2012 Budget	2013 Budget	2014 Budget
Legislative	1.00	1.00	1.00	1.00	1.00	1.00	1.00	1.00	1.00	1.00	1.00	1.00	1.00	1.00
City Administration	7.00	7.80	7.80	9.30	9.35	9.08	9.08	10.00	10.00	10.00	11.00	11.00	11.00	11.00
Community Services	39.50	39.84	42.14	42.56	44.25	44.57	44.93	47.91	49.02	52.44	55.90	56.28	56.28	56.28
Corporate Services	23.33	22.83	22.83	22.96	22.94	24.26	23.91	24.20	25.99	25.63	25.70	25.31	25.66	25.31
Economic Development	3.00	3.30	3.30	3.30	3.30	3.30	3.30	3.30	3.30	3.30	3.30	3.25	3.25	3.25
Public Safety	29.80	29.30	33.30	34.30	34.49	35.34	36.33	38.42	42.08	42.58	42.58	42.58	42.58	42.58
Planning & Development	11.50	12.50	13.00	13.00	13.00	13.00	13.00	13.23	13.00	13.00	13.00	13.00	13.00	13.00
Public Works & Engineering	49.38	49.38	50.21	51.26	51.35	51.92	53.13	54.62	54.67	55.77	55.48	55.71	55.71	55.71
	164.51	165.95	173.58	177.68	179.68	182.47	184.68	192.68	199.06	203.72	207.96	208.13	208.48	208.13
Permanent	146.03	149.53	157.03	161.46	163.46	166.46	168.46	175.96	181.43	186.43	187.04	187.04	187.04	187.04
Term	3.00	0.00	0.00	0.00	0.00	0.00	0.00	0.00	0.00	0.00	0.00	0.00	0.00	0.00
Part-time/ Casual	15.48	16.42	16.55	16.22	16.22	16.01	16.22	16.72	17.63	17.29	20.92	21.09	21.44	21.09
	164.51	165.95	173.58	177.68	179.68	182.47	184.68	192.68	199.06	203.72	207.96	208.13	208.48	208.13
<b>Net change in FTE positions</b>	<b>164.51</b>	<b>1.44</b>	<b>7.63</b>	<b>4.10</b>	<b>2.00</b>	<b>2.79</b>	<b>2.21</b>	<b>8.00</b>	<b>6.38</b>	<b>4.66</b>	<b>4.24</b>	<b>0.17</b>	<b>0.35</b>	<b>-0.35</b>

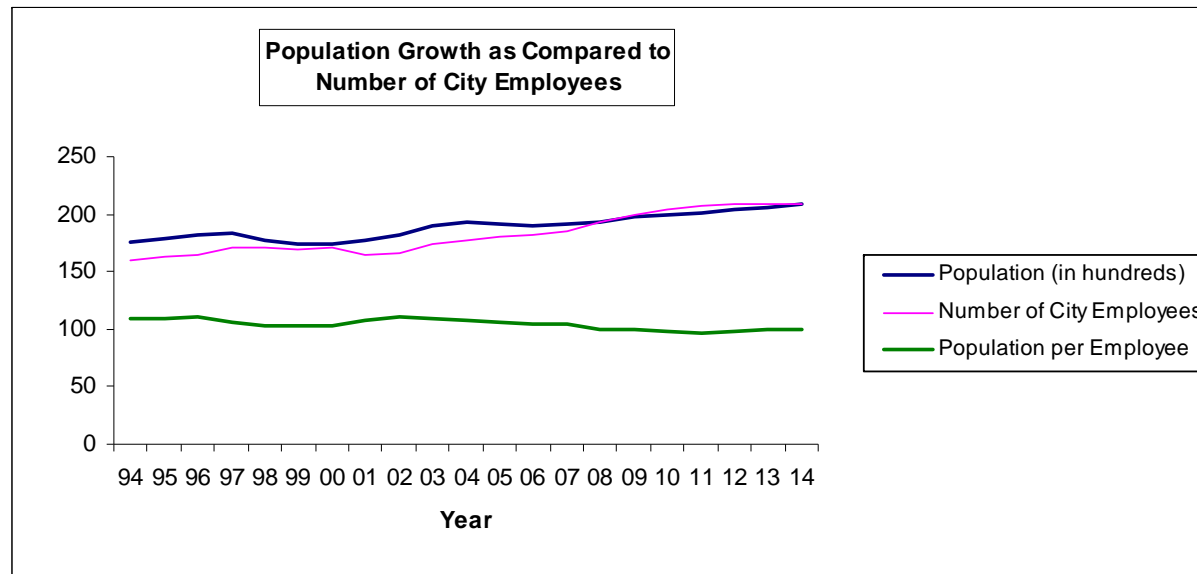

## STAFFING SUMMARY

### Staffing By Department: (FTE)

	2011 Budget	2012 Proposed Revisions	2012 Budget	Note
Legislative	1.00	0.00	1.00	
City Administration	11.00	0.00	11.00	
Community Services	55.90	0.38	56.28	(1)
Corporate Services	25.70	-0.39	25.31	(2)
Economic Development	3.30	-0.05	3.25	(3)
Public Safety	42.58	0.00	42.58	
Planning & Development	13.00	0.00	13.00	
Public Works & Engineering	55.48	0.23	55.71	(4)
	<u>207.96</u>	<u>0.17</u>	<u>208.13</u>	
Permanent	187.04	0.00	187.04	
Part-time/ Casual	20.92	0.17	21.09	
Total	<u>207.96</u>	<u>0.17</u>	<u>208.13</u>	

#### Note:

- (1) Increase casual to meet the increased demands for Library.
- (2) Procurement Services casual 0.35 PY every second year (2011 and 2013) and drop Financial Services casual by 0.04 PY.
- (3) Drop casual by 0.05 PY.
- (4) Increase SW casual to meet to operating requirements of three-cell area.

### Staffing (FTE) Change in Positions

	2011	2012
<b>Positions Added:</b>		
Fieldhouse - Casual	0.66	
Solid Waste Casual		0.69
Communication Officer	1.00	
Arenas Casual	0.26	
Pool Casual	0.79	
Library Casual	0.54	0.39
Procurement Services Casual	0.35	
City Garage Casual	0.34	
Parks Casual	1.50	
Total Additions	<u>5.44</u>	<u>1.08</u>
<b>Positions Dropped:</b>		
Arenas Casual		-0.01
Information Technology Casual	-0.28	
Economic Development Casual		-0.05
Financial Services Casual		-0.04
Procurement Services Casual		-0.35
Library Page	-0.39	
Roads & Sidewalks Casual	-0.03	
Solid Waste Casual	-0.50	
Water & Sewer Casual		-0.23
Roads & Sidewalks Casual		-0.23
	<u>-1.20</u>	<u>-0.91</u>
Net Change	<u>4.24</u>	<u>0.17</u>

# STAFFING SUMMARY

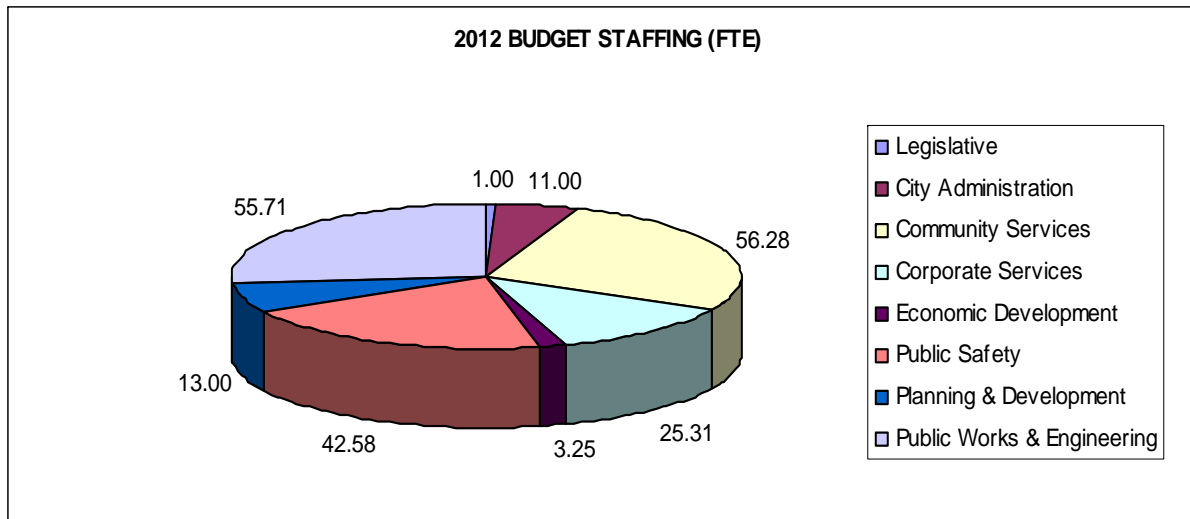
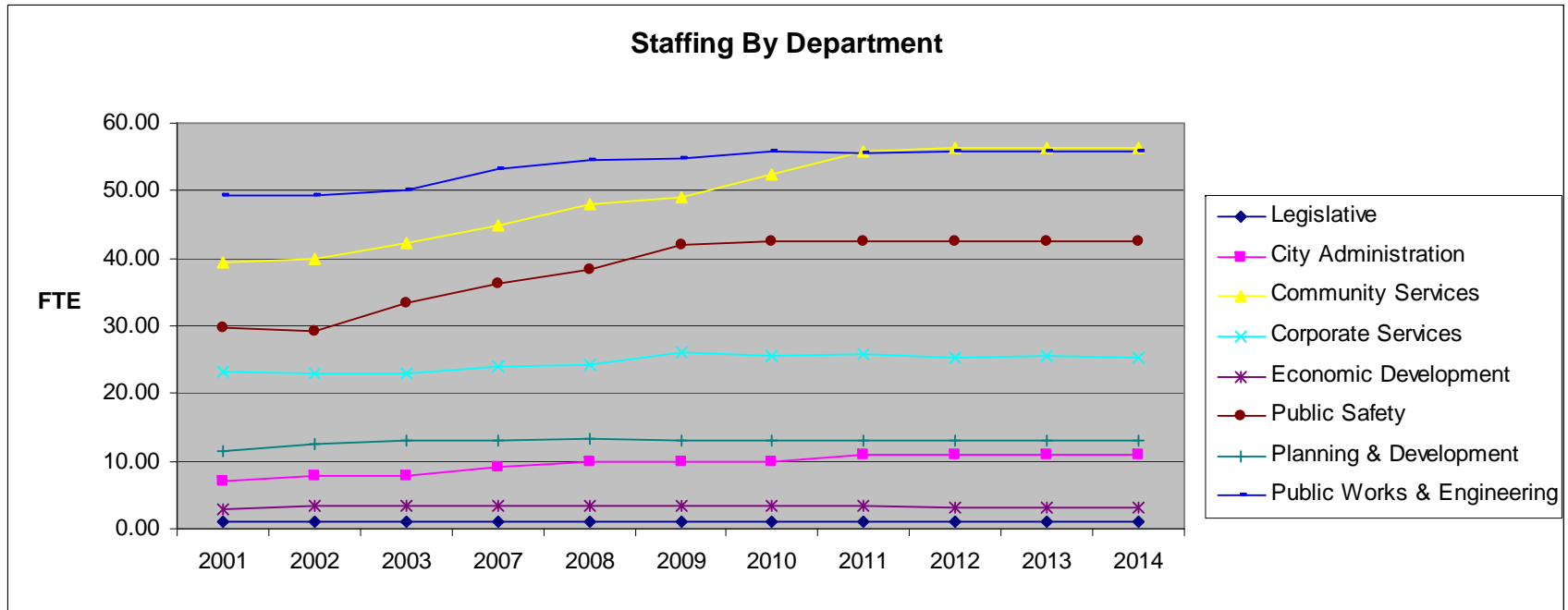

## GENERAL FUND

### General Fund Operations

	2010 Actual (\$000's)	2011 Budget (\$000's)	2011 Forecast (\$000's)	2012 Budget Recommended (\$000's)	2013 Budget (\$000's)	2014 Budget (\$000's)	Note
<b>Revenue</b>							
Taxation	21,412	22,249	22,309	23,178	24,182	25,013	
Taxes Allocated To Capital	(1,084)	(1,436)	(1,299)	(1,452)	(1,452)	(1,452)	
Government Transfers	202	168	188	168	168	168	
User Charges	6,344	6,929	6,896	6,988	7,124	7,195	
Investment Income	248	145	162	120	100	100	
	<b>27,121</b>	<b>28,055</b>	<b>28,254</b>	<b>29,002</b>	<b>30,123</b>	<b>31,024</b>	
<b>Expenditures (By Activity)</b>							
General Government	9,244	9,142	8,979	9,435	9,850	9,972	
Community Services	6,890	7,366	7,585	7,666	7,964	8,215	
Public Safety	4,873	5,275	5,289	5,504	5,687	6,035	
Planning & Development	1,438	1,645	1,582	1,647	1,741	1,792	
Public Works	5,977	6,016	6,259	6,213	6,405	6,584	
Amortization	3,952	4,714	4,714	5,065	5,248	5,412	
	<b>32,376</b>	<b>34,158</b>	<b>34,410</b>	<b>35,529</b>	<b>36,896</b>	<b>38,011</b>	
<b>Net Revenue (Expenditures)</b>	<b>(5,255)</b>	<b>(6,103)</b>	<b>(6,155)</b>	<b>(6,527)</b>	<b>(6,773)</b>	<b>(6,986)</b>	
<b>Interfund Transfers</b>							
(To) From Water & Sewer Fund	1,063	1,068	1,089	1,111	1,147	1,184	
(To) From Solid Waste Fund	205	182	219	221	246	257	
(To) From Land Fund	175	175	175	175	175	175	
(To) From Twin Pine Hill Reserve	(2)	-	-	-	-	-	
(To) From Samuel Colley Library Donation Reserve	(1)	-	-	-	-	-	
(To) From Heritage Reserve	(31)	-	-	-	-	-	
(To) From Downtown Dev. Reserve	(101)	(27)	(42)	(42)	(43)	(43)	
Change in Fund Balance Before Reallocation of Amortization	(3,947)	(4,706)	(4,714)	(5,063)	(5,248)	(5,412)	
Reallocation of Amortization	3,952	4,714	4,714	5,065	5,248	5,412	
<b>Change in Fund Balance</b>	<b>5</b>	<b>8</b>	<b>-</b>	<b>2</b>	<b>-</b>	<b>-</b>	
<b>Opening Balance</b>	<b>2,072</b>	<b>2,310</b>	<b>2,077</b>	<b>2,077</b>	<b>2,079</b>	<b>2,080</b>	
<b>Closing Balance</b>	<b>2,077</b>	<b>2,318</b>	<b>2,077</b>	<b>2,079</b>	<b>2,080</b>	<b>2,079</b>	(1)

#### Notes:

- (1) Out of the closing balance \$2,077,000 in 2011 Forecast, \$58,000 is the restricted trust fund which has been set up for future firefighter training as a result of the agreement signed between the Workers' Safety & Compensation Commission of Northwest Territories and Nunavut and City on October 6, 2006.



## GENERAL FUND

### Expenditures by Activity And Division

	2010 Actual (\$000's)	2011 Budget (\$000's)	2011 Forecast (\$000's)	2012 Budget Recommended (\$000's)	2013 Budget (\$000's)	2014 Budget (\$000's)
<b>General Government</b>						
Fiscal Services	496	291	369	408	387	388
Mayor & Council	1,387	1,230	1,144	1,129	1,183	1,170
City Administrator	2,087	2,325	2,137	2,442	2,548	2,579
Corporate Services	4,674	4,686	4,707	4,836	5,098	5,187
Economic Development	601	611	623	620	634	648
	<b>9,244</b>	<b>9,142</b>	<b>8,979</b>	<b>9,435</b>	<b>9,850</b>	<b>9,972</b>
<b>Community Services</b>						
Administration	552	596	613	729	748	767
City Hall	306	326	330	341	348	357
Arenas	1,875	1,830	1,953	1,837	1,961	2,034
Fieldhouse	308	626	675	717	735	758
Curling Club	144	140	132	125	127	130
Parks	888	968	980	985	1,011	1,038
Library	994	1,092	1,076	1,144	1,172	1,203
Pool	1,351	1,379	1,419	1,382	1,444	1,499
Wildcat	14	11	7	14	15	15
Recreation	460	398	399	393	404	414
	<b>6,890</b>	<b>7,366</b>	<b>7,585</b>	<b>7,666</b>	<b>7,964</b>	<b>8,215</b>
<b>Public Safety</b>						
Administration	177	184	184	183	186	193
Fire & Ambulance	3,404	3,713	3,655	3,845	3,983	4,283
Municipal Enforcement	1,292	1,378	1,451	1,476	1,518	1,560
	<b>4,873</b>	<b>5,275</b>	<b>5,289</b>	<b>5,504</b>	<b>5,687</b>	<b>6,035</b>
<b>Planning &amp; Development</b>						
Administration	262	274	306	436	450	466
Building Inspections	482	526	522	466	480	496
Planning & Lands	695	845	755	745	810	830
	<b>1,438</b>	<b>1,645</b>	<b>1,582</b>	<b>1,647</b>	<b>1,741</b>	<b>1,792</b>
<b>Public Works</b>						
Administration	1,002	1,076	1,087	1,096	1,124	1,153
City Garage	682	534	614	575	591	607
Public Transit	1,028	1,062	1,083	1,083	1,116	1,149
Roads & Sidewalks	3,265	3,344	3,475	3,459	3,574	3,675
	<b>5,977</b>	<b>6,016</b>	<b>6,259</b>	<b>6,213</b>	<b>6,405</b>	<b>6,584</b>



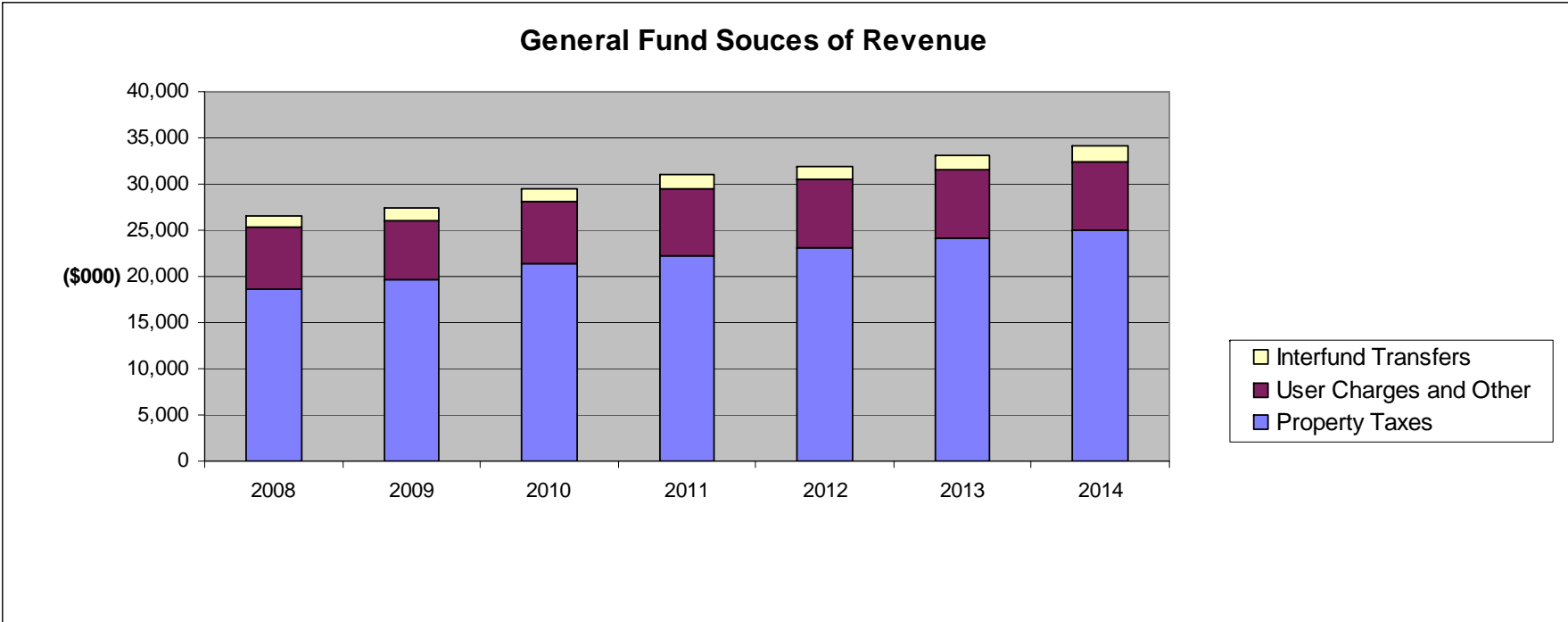

THIS PAGE LEFT BLANK INTENTIONALLY



**GENERAL FUND - Fiscal Services**

**Fiscal Services Budget**

	2010 Actual (\$000's)	2011 Budget (\$000's)	2011 Forecast (\$000's)	2012 Budget Recommended (\$000's)	2013 Budget (\$000's)	2014 Budget (\$000's)	Note
<b>Revenue</b>							
Taxation	21,412	22,249	22,309	23,178	24,182	25,013	(1)
Taxes Allocated to Capital	(1,084)	(1,436)	(1,299)	(1,452)	(1,452)	(1,452)	(2)
User Charges:							
Power Distribution Franchise Fee	860	893	883	878	882	915	
Tax Penalties	261	300	262	269	273	277	
others	78	70	65	70	75	-	(3)
Investment Income	248	145	162	120	100	100	
	<u>21,775</u>	<u>22,221</u>	<u>22,382</u>	<u>23,063</u>	<u>24,060</u>	<u>24,853</u>	
<b>Expenditures (By Object)</b>							
Cash Management	177	166	194	183	187	188	
Valuation Allowance	318	100	150	200	200	200	
Others	-	25	25	25	-	-	
	<u>496</u>	<u>291</u>	<u>369</u>	<u>408</u>	<u>387</u>	<u>388</u>	
<b>Net Revenue (Expenditures)</b>	<u>21,280</u>	<u>21,930</u>	<u>22,013</u>	<u>22,655</u>	<u>23,673</u>	<u>24,465</u>	
<b>Interfund Transfers</b>							
From Water & Sewer Fund	1,063	1,068	1,089	1,111	1,147	1,184	(4)
From Solid Waste Fund	205	182	219	221	246	257	(4)
From Land Development Fund	175	175	175	175	175	175	(4)
	<u>1,443</u>	<u>1,424</u>	<u>1,483</u>	<u>1,506</u>	<u>1,568</u>	<u>1,616</u>	
	<u>22,722</u>	<u>23,354</u>	<u>23,496</u>	<u>24,162</u>	<u>25,241</u>	<u>26,081</u>	

**Notes:**

- (1) 2012 property taxes are based on 2011 assessed values. Growth in 2011 assessed values is based on a review of building permits to September 2011. Property taxation includes payments-in-lieu of taxes by the federal and territorial governments as well as Crown corporations. 2011 assessment growth was based on a 1.1% increase from property development. The increase in taxation is based on the assumption that the mill rate will increase by 2.83% in 2012, 2.95% in 2013 and 2.48% in 2014.
- (2) Taxes allocated to the Capital Fund are used to pay principal and interest on general capital debt and for funding capital projects.
- (3) Infrastructure Development Funding for Giant Mine Emergency Services provided by Aboriginal Affairs and Northern Development Canada will expire in March 2014.
- (4) Salaries and overhead costs associated with administering other Funds are recovered by charging administration fees. The Water and Sewer Fund is charged a fee of 15% of its revenue and the Solid Waste Management Fund is charged a fee of 10% of its revenue. The Land Development Fund is charged at a minimum of \$100,000 subject to achieving its minimum balance of nil.

## GENERAL FUND - Fiscal Services

### 2012 Property Tax Revenue

Classification	Mill Rate	2011 Assessment (000's)	2011 Growth (000's)	2012 Revenue (000's)	Growth (%)
Residential	8.48	842,992	13,678	7,268	1.6%
Multi-residential	9.12	271,814	454	2,483	0.2%
Commercial/Industrial	15.52	583,717	8,271	9,186	1.4%
Mining & Quarrying	17.53	9,562	0	168	0.0%
High Density Parking	8.10	3,940	81	33	2.1%
Agriculture	8.48	1,864	109	17	5.8%
		<u>1,713,889</u>	<u>22,593</u>	<u>19,154</u>	<u>1.3%</u>
Exempt Properties		0	0	-61	0.0%
		<u>1,713,889</u>	<u>22,593</u>	<u>19,093</u>	<u>1.3%</u>

Classification	Mill Rate	2011 Assessment (000's)	2011 Growth (000's)	2012 Revenue (000's)	Growth (%)
----------------	-----------	----------------------------	------------------------	-------------------------	------------

### Government of the Northwest Territories

Residential	8.48	2,485	0	21	0.0%
Multi-residential	9.12	3,955	0	36	0.0%
Commercial/Industrial	15.52	167,888	56	2,606	0.0%
Mining & Quarrying	17.53	0	0	0	0.0%
		<u>174,328</u>	<u>56</u>	<u>2,663</u>	<u>0.0%</u>

### Government of Canada

Residential	8.48	33,856	0	287	0.0%
Multi-residential	9.12	16,017	0	146	0.0%
Commercial/Industrial	15.52	55,557	0	862	0.0%
		<u>105,430</u>	<u>0</u>	<u>1,295</u>	<u>0.0%</u>

### Crown Corporations

Residential	8.48	0	0	0	0.0%
Commercial/Industrial	15.52	8,190	0	127	0.0%
		<u>8,190</u>	<u>0</u>	<u>127</u>	<u>0.0%</u>
		<u>287,948</u>	<u>56</u>	<u>4,086</u>	<u>0.0%</u>

<b>Total</b>		<u>2,001,837</u>	<u>22,649</u>	<u>23,178</u>	<u>1.1%</u>
--------------	--	------------------	---------------	---------------	-------------



**GENERAL FUND - Mayor & Council**

**Staffing Summary**

	2001 Actual	2002 Actual	2003 Actual	2004 Actual	2005 Actual	2006 Actual	2007 Actual	2008 Actual	2009 Actual	2010 Actual	2011 Actual	2012 Budget	2013 Budget	2014 Budget
Legislative	1.00	1.00	1.00	1.00	1.00	1.00	1.00	1.00	1.00	1.00	1.00	1.00	1.00	1.00
Permanent Positions	1.00	1.00	1.00	1.00	1.00	1.00	1.00	1.00	1.00	1.00	1.00	1.00	1.00	1.00

**Mayor & Council Budget**

	2010 Actual (\$000's)	2011 Budget (\$000's)	2011 Forecast (\$000's)	2012 Budget Recommended (\$000's)	2013 Budget (\$000's)	2014 Budget (\$000's)	Note
<b>Revenue</b>							
Government Transfers							
Formula Funding	-	-	-	-	-	-	
Other	15	-	-	-	-	-	
	15	-	-	-	-	-	
<b>Expenditures (By Activity)</b>							
Legislation & Governance	653	560	489	570	589	607	
Public Information	49	51	51	56	56	56	
Strategic Planning	31	-	-	-	34	-	(1)
Community Assistance	509	544	529	504	505	507	(2)
Contingency	145	75	75	-	-	-	
	1,387	1,230	1,144	1,129	1,183	1,170	
<b>Net Revenue (Expenditures)</b>	(1,372)	(1,230)	(1,144)	(1,129)	(1,183)	(1,170)	
<b>Expenditures (By Object)</b>							
Wages & Benefits	554	429	363	439	455	470	
Other O&M	833	801	781	690	728	700	
	1,387	1,230	1,144	1,129	1,183	1,170	

**Note:**

- (1) It is for conducting citizen survey every two years.
- (2) During the annual budget deliberations City Council determines the total dollar amount of grants to be given out during the fiscal year. Once a year, City Council will hear specific requests for special grants. These special grants will only be granted if funding is available after the budget is adopted. City Council may make grants for purposes that, in the opinion of Council, will benefit the residents of the municipality.  
Property tax rebates for seniors and disabled taxpayers are provided on equal cost-sharing basis with the GNWT to a maximum of \$2,000 per year. The total amount of all grants made by City Council must not exceed 2% of total budgeted expenditures.

**GENERAL FUND - Mayor & Council**

**Mayor & Council Performance Measures**

	<b>Actual 2005</b>	<b>Actual 2006</b>	<b>Actual 2007</b>	<b>Actual 2008</b>	<b>Actual 2010</b>	<b>Forecasted 2012</b>	<b>Note (1)</b>
<b>Effectiveness Measures</b>							
% of citizens who rate overall quality of life in Yellowknife as very good or good	95%	96%	96%	93%	95%	96%	
% of citizens very satisfied or somewhat satisfied with overall level and quality of City's services and programs	88%	87%	92%	86%	84%	88%	
% of citizens who approve of City Council's performance	75%	73%	77%	77%	73%	77%	
% of citizen feel they receive "very good" or "good" value of their tax dollars	78%	75%	76%	72%	-	-	
% of citizens who feel the quality of life in Yellowknife in the past three years improved or stayed the same	75%	71%	74%	71%	77%	78%	

**Note:**

(1) Citizen Survey will be conducted every 2 years.

	2010 Actual (\$000's)	2011 Budget (\$000's)	2011 Forecast (\$000's)	2012 Budget Recommended (\$000's)	2013 Budget (\$000's)	2014 Budget (\$000's)
<b>Grants</b>						
Senior Citizens/Disabled Tax Rebate	82	80	80	85	87	89
Core Grants	337	355	340	314	308	308
Special Grants	91	109	109	105	110	110
	509	544	529	504	505	507



# GENERAL FUND - Mayor & Council

	2010 Actual (\$)	2011 Budget (\$)	2011 Forecast (\$)	2012 Budget Recommended (\$)	2013 Budget (\$)	2014 Budget (\$)
<b>Core Grants</b>						
Aurora Fiddlers Association				4,500		
Aurora Arts Society		5,000	5,000	7,000		
Canadian Championship Dog Derby Association	15,000	15,000	15,000	15,000		
Caribou Carnival	15,000					
Ecology North	20,000	20,000	20,000	20,000		
Festival of the Midnight Sun	5,000	2,000	2,000	2,000		
Folk on the Rocks	10,000	10,000	10,000	10,000		
Foster Family Coalition of NWT		4,500	4,500	4,500		
North Word Writers Festival Society				3,500		
Northern Arts & Cultural Centre	80,000	80,000	80,000	80,000		
NWT Council For Persons With Disabilities	18,500	22,000	22,000	25,000		
Side Door Youth Ministries	45,000	45,000	45,000			
Special Olympics NWT	4,000	4,000	4,000	5,000		
St. John Ambulance	12,000	10,000	10,000	10,000		
The Snow King Winter Festival	10,000					
Yellowknife Association for Community Living	10,000	10,500	10,500	11,000		
Yellowknife Golf Club		15,000	15,000	15,000		
Yellowknife Guild of Arts & Crafts		5,000	5,000	5,000		
Yellowknife International Airshow Society	10,000	10,000	10,000	10,000		
Yellowknife Marine Rescue Society				4,500		
Yellowknife Playgroup Association	2,000	2,000	2,000	2,000		
Yellowknife Seniors Society	55,000	55,000	55,000	55,000		
Yellowknife Ski Club	25,000	25,000	25,000	25,000		
	<b>321,500</b>	<b>355,000</b>	<b>340,000</b>	<b>314,000</b>	<b>308,000</b>	<b>308,000</b>
<b>Special Grants</b>						
Aurora Arts Society	3,000					
Aurora Fiddlers Society	2,000		4,000			
Caribou Carnival Raven Mad Daze	7,500					
Classics on Stage YK	5,000		5,000			
Federation Franco-Tenoise			7,000			
Food Rescue	5,000		5,000			
Foster Family Camp Connections	5,000					
Frozen Eyes Photographic Society			2,000			
Great Slave Snowmobile Association			10,000			
Kole Crook Fiddle Association			8,000			
L'Association Franco-Culturelle de Yellowknife			10,000			
N.J. Macpherson School	5,100					
North Word Writers Festival Society	3,500					
Northern Writers Festival			3,500			
NWT SPCA			8,500			
NWT Mining Heritage Society	1,000		2,500			
NWT Playwright Association	907					
Range Lake North School PAC			5,000			
Side Door Youth Ministries	2,500					
Smart Committee Society	1,000					
Somba K'e Paddling Society	1,000					
Status of Women Council			10,000			
Rotary Club of YK	1,000					
YK Curling Club			6,000			
YK Golf Club	5,000					
YK Community Garden Collective	4,000		2,000			
YK Climbing Club	10,000					
YK Curling Centre	2,285					
YK Church of Christ			4,000			
YK Guild of Arts & Crafts	1,000					
YK United Soccer			2,000			
Yellowknife Gymnastics Club	10,000		9,500			
YWCA Yellowknife			5,000			
Yellowknife Marine Rescue Society	10,000					
Western Arctic Moving Pictures	5,000					
	<b>90,792</b>	<b>109,000</b>	<b>109,000</b>	<b>105,000</b>	<b>110,000</b>	<b>110,000</b>



THIS PAGE LEFT BLANK INTENTIONALLY



**GENERAL FUND - City Administrator**

**Department Staffing**

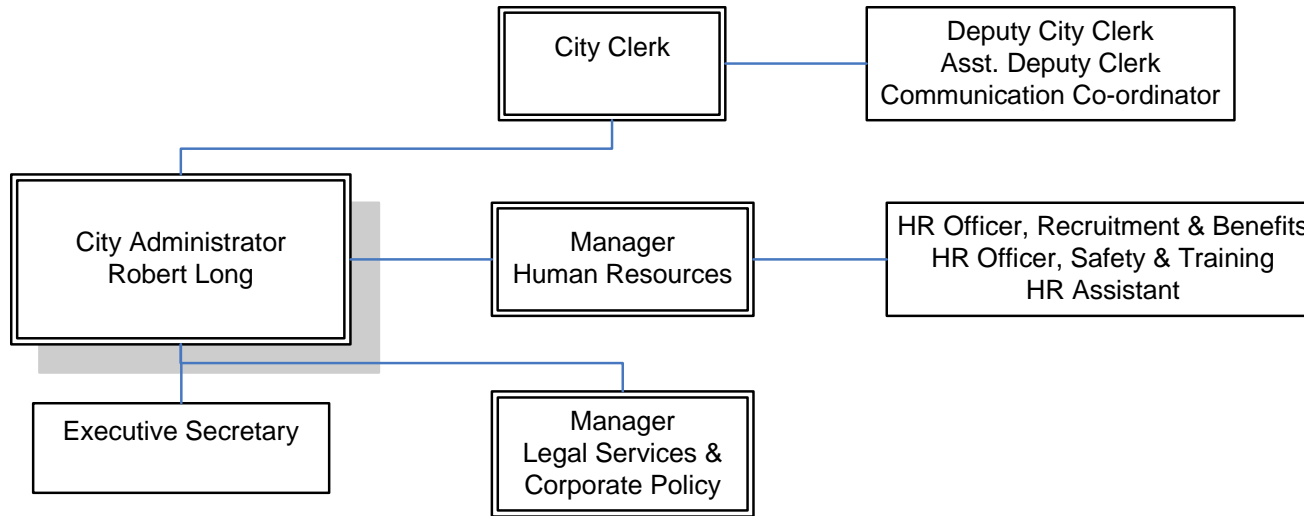

**Staffing Summary**

	2001 Actual	2002 Actual	2003 Actual	2004 Actual	2005 Actual	2006 Actual	2007 Actual	2008 Actual	2009 Actual	2010 Actual	2011 Actual	2012 Budget	2013 Budget	2014 Budget	Note
City Administrator's Office	2.00	2.00	2.00	3.00	3.00	3.00	3.00	3.00	3.00	3.00	3.00	3.00	3.00	3.00	(1)
City Clerk's Office	2.00	2.80	2.80	3.30	3.35	3.00	3.00	3.00	3.00	3.00	4.00	4.00	4.00	4.00	(2)
Human Resources	3.00	3.00	3.00	3.00	3.00	3.08	3.08	4.00	4.00	4.00	4.00	4.00	4.00	4.00	(3)
	<b>7.00</b>	<b>7.80</b>	<b>7.80</b>	<b>9.30</b>	<b>9.35</b>	<b>9.08</b>	<b>9.08</b>	<b>10.00</b>	<b>10.00</b>	<b>10.00</b>	<b>11.00</b>	<b>11.00</b>	<b>11.00</b>	<b>11.00</b>	
Permanent Positions	7.00	7.50	7.50	9.00	9.00	9.00	9.00	10.00	10.00	10.00	11.00	11.00	11.00	11.00	
Part-time / casual	0.00	0.30	0.30	0.30	0.35	0.08	0.08	0.00	0.00	0.00	0.00	0.00	0.00	0.00	
	<b>7.00</b>	<b>7.80</b>	<b>7.80</b>	<b>9.30</b>	<b>9.35</b>	<b>9.08</b>	<b>9.08</b>	<b>10.00</b>	<b>10.00</b>	<b>10.00</b>	<b>11.00</b>	<b>11.00</b>	<b>11.00</b>	<b>11.00</b>	

Note:

- (1) Starting from 2004, Manager of Legal Services and Corporate Policy reports directly to the City Administrator.
- (2) Communication Officer from July 1, 2011 onwards.
- (3) HR Officer -Training & Safety from July 2008 onwards.

### CITY ADMINISTRATOR'S OFFICE

The City Administrator's Office has overall responsibility for the administration of the Municipal Corporation. This includes developing corporate policy as well as providing policy advice to Council regarding the City's organization and operating procedures. The City Administrator's Office provides administrative leadership, coordination of interdepartmental activities, directs the implementation of Council-approved policies and administers the appropriate policy controls to ensure that all City programs are delivered effectively and efficiently while encouraging innovation and creativity in programs.

The City Administrator's Office provides leadership to the City's six departments: Community Services; Corporate Services; Economic Development; Planning and Development; Public Works and Engineering; and Public Safety. Each department is led by a director. Further, the City Administrator has responsibility for the services of the City Clerk's Division, the Human Resources Division and the Corporate Policy and Legal Services Division. Each division is headed by a manager.

Following Council's Strategic Plan, Administration focused on three priority areas in addition to the effective day-to-day operations of the City. These areas include: the establishment of the Con Mine District Energy Project; the downtown revitalization program; and a waterfront/harbour planning process. These projects and processes will culminate in the coming years in a new approach to the Community Energy Plan, the City's General Plan and waterfront development. Using the City's Smart Growth Plan, the City is developing objectives to complete the implementation of these principles within a series of planning processes. The City is in active negotiations with Corix Inc. to complete the district energy implementation of the Community Energy Plan. We are also negotiating with land owners on 50<sup>th</sup> Street to assemble land for a redevelopment opportunity that will revitalize the downtown core of Yellowknife. The Waterfront Harbour Plan will also establish new guidelines for more public use of the waterfront and suggestions for improved development in waterfront areas of Yellowknife.

To establish an understanding of the City's future costs for depreciated infrastructure, we implemented an asset management plan and determined the depreciated value of all City assets. This evaluation will help Council establish priorities for future capital and maintenance

expenditures. It is hoped that this evaluation will lead to a firm asset management plan including future taxation implications.

Administration is developing evaluation criteria to determine our City's performance against our own objectives and that of other Cities our size.

Administration continues to integrate the objectives outlined in Council's Strategic Plan into this budget document.

#### **Goal # 1**      **Affordability**

##### **Objectives:**

- 1.1 Realize opportunities to encourage economic growth and diversity.
- 1.2 Adopt a sustainable and practical approach to infrastructure deficit reduction.
- 1.3 Pursue creative market partnerships to promote affordable living.
- 1.4 Emphasize fairness and transparency in financial decisions, program delivery and land assembly.

##### **Actions:**

- 1(a) Establish a Community Affordability Task Force.
- 1(b) Review the City's land development policies.
- 1(c) Develop an implementation plan for housing supply options and partnerships.
- 1(d) Develop opportunities for joint ventures with other orders of government and the private sector to meet the affordability goal.

#### **Goal # 2**      **Enhancing Our Built Environment**

##### **Objectives:**

- 2.1 Maintain, respect, preserve and enhance the natural environment, natural heritage and green space.



- 2.2 Improve transit, roads, sidewalks, recreation facilities and trails with an emphasis on active transportation.
- 2.3 Develop smart and sustainable approaches to energy, water and sewer, waste management, and building systems.
- 2.4 Promote a range of commercial, residential, and institutional development and revitalization opportunities.

**Actions:**

- 2(a) Address the infrastructure deficit.
- 2(b) Develop a plan for the Capital Area.
- 2(c) Develop an implementation plan for district energy.
- 2(d) Complete and implement a Harbour Plan.
- 2(e) Develop an implementation plan for downtown revitalization.

**Goal # 3      Building Social Capital (Community Engagement)**

**Objectives:**

- 3.1 Develop prosperity through strategic partnerships.
- 3.2 Improve quality of life by promoting healthy and active lifestyle choices.
- 3.3 Improve community participation and volunteerism opportunities.
- 3.4 Promote heritage, culture, arts and other unique characteristics of Yellowknife to honour our past and preserve/showcase our history and cultural diversity.

**Actions:**

- 3(a) Build and enhance relationships with First Nations, the private and public sectors.
- 3(b) Develop a Communication Plan to improve engagement with the community.
- 3(c) Enhance recreational programs and promote Yellowknife as an excellent place to live and play.

**Goal # 4**

**Continuous Improvement**

**Objectives:**

- 4.1 Be accountable to residents by ensuring open and accessible information flow and accessible decision-making.
- 4.2 Create an environment of mutual respect, open dialogue, and teamwork.
- 4.3 Recognize and reward performance.
- 4.4 Be a leader in innovation.

**Actions:**

- 4(a) Develop a customer service culture.
- 4(b) Lead in innovation and best practices.
- 4(c) Become a preferred employer.
- 4(d) Develop enhanced accountability measures.
- 4(e) Streamline Council's committee structure.
- 4(f) Enhance marketing of Yellowknife.

**GENERAL FUND - City Administrator**

**Administration Department Budget**

	2010 Actual (\$000's)	2011 Budget (\$000's)	2011 Forecast (\$000's)	2012 Budget Recommended (\$000's)	2013 Budget (\$000's)	2014 Budget (\$000's)
<b>Revenue</b>						
Grants	2	-	-	-	-	-
	2	-	-	-	-	-
<b>Expenditures (By Division)</b>						
City Administrator	586	576	575	579	597	610
City Clerk	389	529	482	675	666	685
Human Resources	1,112	1,219	1,080	1,188	1,286	1,284
	2,087	2,325	2,137	2,442	2,548	2,579
<b>Net Revenue (Expenditures)</b>	(2,085)	(2,325)	(2,137)	(2,442)	(2,548)	(2,579)
<b>Expenditures (By Object)</b>						
Wages & Benefits	1,327	1,444	1,271	1,531	1,668	1,713
Other O&M	759	881	866	911	880	866
	2,087	2,325	2,137	2,442	2,548	2,579

**City Administrator Budget**

	2010 Actual (\$000's)	2011 Budget (\$000's)	2011 Forecast (\$000's)	2012 Budget Recommended (\$000's)	2013 Budget (\$000's)	2014 Budget (\$000's)
<b>Revenue</b>						
Grants	-	-	-	-	-	-
	-	-	-	-	-	-
<b>Expenditures (By Activity)</b>						
Legislation & Governance	217	213	213	214	221	226
Policy Development	281	277	276	278	287	293
Public Information	88	86	86	86	89	91
	586	576	575	579	597	610
<b>Net Revenue (Expenditures)</b>	(586)	(576)	(575)	(579)	(597)	(610)
<b>Expenditures (By Object)</b>						
Wages & Benefits	448	470	469	472	490	503
Other O&M	138	106	106	107	107	107
	586	576	575	579	597	610



### CITY CLERK

The City Clerk's Office provides legislative support services to City Council, its Standing and Special Committees, Administration, the Development Appeal Board, and the Board of Revision. As part of its legislative support services, the City Clerk's Office ensures that the process of Council is followed as prescribed in the Council Procedures By-law and applicable municipal, territorial and federal legislation.

### 2011 Highlights

The highlights of the City Clerk's Office include:

- Continuation and enhancement of the City's weekly flyer, Capital Update;
- Provision of administrative support to the 2010 Yellowknife Board of Revision, the Development Appeal Board, City Council and Standing Committees of Council;
- Coordination, production and distribution of Council and Committee agendas and reports, both in hard copy and on the City's website;
- Assisting departments to research and draft Memorandums to Committee and By-laws;
- Continuation and enhancement of the Public Information Program through public service announcements, media advisories, news releases, press conferences and news articles on the City's website;
- Training new employees on records management software;
- Maintaining website content;
- Development of an ongoing Voters List;
- Participating on the Communications Study Steering Committee;
- Participating on the One-Stop Shopping Steering Committee.

### 2012/2013/2014 Goals

The goals of the City Clerk's Office are to:

- Provide accurate and timely legislative support services to City Council, its standing and special committees, Administration, the Development Appeal Board and the Board of Revision;
- Conduct municipal elections, by-elections and voter approvals in accordance with territorial legislation;

- Enhance the Records Management Program by further educating and assisting staff with new technologies with the records management software;
- Continue and enhance the Public Information Program;
- Establish standards for the City's corporate image;
- Continue the transition to a "paperless" environment;
- Assist with the implementation of a One-Stop Shopping model for customer service.

### 2011/2012/2014 Objectives

The objectives of the City Clerk's Office are to:

- Review Council and Administrative policies to identify obsolescence and reflect technological advancements;
- Review and assist each department's records management and storage practices;
- Develop a Records Management and Storage Policy;
- Identify publication standards to be used throughout the corporation;
- Ensure website content reflects the needs of the community and is updated on a regular basis;
- Achieve 95% efficiency on profiling documents within the Electronic Document Management System;
- Enhance the public information program through media relations and website content;
- Initiate webcasting of Council and Committee meetings;
- Assist City departments in researching past Council motions, City archives and by-laws;
- Assist with the implementation of a One-Stop Shopping model for customer service.

**GENERAL FUND - City Administrator**

**City Clerk Budget**

	2010 Actual (\$000's)	2011 Budget (\$000's)	2011 Forecast (\$000's)	2012 Budget Recommended (\$000's)	2013 Budget (\$000's)	2014 Budget (\$000's)	Note
<b>Revenue</b>							
Grants	-	-	-	-	-	-	
<b>Expenditures (By Activity)</b>							
Legislation & Governance	244	272	248	286	374	386	
Board Support	25	30	27	59	62	64	
Election Administration	15	14	13	135	19	20	(1)
Public Information	95	201	183	182	187	192	
Records Management	11	12	11	14	24	24	
	<u>389</u>	<u>529</u>	<u>482</u>	<u>675</u>	<u>666</u>	<u>685</u>	
<b>Net Revenue (Expenditures)</b>	<u>(389)</u>	<u>(529)</u>	<u>(482)</u>	<u>(675)</u>	<u>(666)</u>	<u>(685)</u>	
<b>Expenditures (By Object)</b>							
Wages & Benefits	311	326	278	432	458	473	(2)
Other O&M	78	203	204	243	208	212	
	<u>389</u>	<u>529</u>	<u>482</u>	<u>675</u>	<u>666</u>	<u>685</u>	

**Notes:**

- (1) General election for the City Council in 2012.
- (2) A Communication Co-ordinator was approved by Council starting July 1, 2011.



**GENERAL FUND - City Administrator**

---

**City Clerk Performance Measures**

	Projected 2010	Actual 2010	Projected 2011	Forecasted 2012	Forecasted 2013	Forecasted 2014	Notes
<b>Workload Indicators:</b>							
Council & Committee meetings attended	90	87	70	70	90	90	
Directors meetings	50	49	50	50	50	50	
By-laws reviewed in preparation for Council	50	67	50	50	50	50	
Memorandums to Committee reviewed	195	193	195	195	195	195	
<b>Efficiency Measures:</b>							
% of minutes prepared and distributed within timeframe as defined in the Council Procedures By-law	100%	100%	100%	100%	100%	100%	
Average weekly cost of advertising (includes both print and radio)	\$1,770	\$1,400	\$1,600	\$2,732	\$2,732	\$2,732	(1)
<b>Effectiveness Measures:</b>							
# of weekly advertising circulars delivered	7,046	7,000	6,500	6,500	7,000	7,000	
<b>Mayor/Council Election:</b>							
Voter turnout	-	-	-	50%	-	-	(2)
Voter turnout for approval of By-laws	-	-	35%	35%	35%	35%	(3)

**Notes:**

- (1) A Communications Officer will be starting in 2012 and the advertising budget has been increased to allow for additional communication initiatives.
- (2) It was 29% in 2006 and 48% in 2009.
- (3) It is anticipated that voter approval will be sought for a Debenture By-law to borrow for water and sewer infrastructure and a Local Improvement By-law for the water and sewer infrastructure for Northlands Condo Corp #8.



### HUMAN RESOURCES

The Human Resources Division is responsible for providing services in workforce planning, recruitment, retention, benefit administration, compensation/payroll, labour relations, employment contract interpretation and negotiations, occupational safety and health, policy development and employee development/training to the City's approximately 225 permanent and casual employees.

#### 2011 Highlights

The highlights of the Human Resources Division include:

- Continued enhancement of the City's Safety Program, focusing on ongoing hazard assessments, safe work practices, proper recording and documentation, and preparation for a formal auditing program which includes receiving certification under the Certificate of Recognition (COR) program;
- Finalized contract negotiations with the PSAC, local X0345, for a two-year collective agreement;
- Holding regular Joint Consultation Committee meetings with two unions to enhance positive labour relations;
- Recruited for the organization in a difficult market, particularly in some professions;
- Increased in-house training opportunities for staff by developing several City of Yellowknife specific programs such as Fall Arrest, First Aid/CPR training, and Confined Space Entry;
- Successfully implemented the transfer to electronic pay statements and tax forms;
- Developed and implemented a new policy for retention of employee personnel files to reduce the amount of space required for storage.

#### 2012/2013/2014 Goals

The goals of the Human Resources Division are to:

- Provide a comprehensive workforce planning, staffing and recruitment service that ensures qualified employees are hired to perform effectively and efficiently to assist the City in achieving its goals;
- Foster collaborative workplace relationships to ensure the workplace is a harmonious and safe environment where both management and employees work together for the same objectives;

- Demonstrate high standards of ethical behavior, including the protection of confidentiality and the promotion of fair and equitable treatment of all employees;
- Provide a comprehensive benefits package that meets the needs of all employees, including assisting with disability management and accommodation needs;
- Promote, encourage and organize the acquisition of knowledge and skills for employees through a comprehensive training and development program;
- Develop and maintain strategies to enhance the flow of information between the City and its employees;
- Provide guidance, monitoring and direction of the City's Occupational Health and Safety Program, with the goal of reducing and preventing injuries on the job;
- Manage accurate and timely human resource information and to respond to customer needs by providing this information promptly;
- Further develop reporting capabilities for occupational safety and health and training;
- Review and adjust where necessary all Human Resources policies, including policies under the Safety Program;
- Foster policy development in new areas where required;
- Review, redefine and monitor a comprehensive attendance management program that will lead to reduced absenteeism;
- Evaluate and adjust the workplace wellness program to encourage healthy lifestyles for employees;
- Further increase in-house training where possible in order to enhance the quality of training (organization specific) while reducing the cost to the City.
- Review and initiate changes to existing policies and practices for approvals on compensation and benefit-related forms, with the goal of moving towards digital forms where possible.

#### 2012/2013/2014 Objectives

The objectives to meet these goals are:

- Staffing vacancies in a timely and cost-effective manner with suitable and qualified persons in accordance with the merit principle;
- Reviewing and revising recruitment strategies, including which



markets to draw from (advertising strategy), according to labour market conditions;

- Ensuring that job descriptions accurately reflect the duties and responsibilities of positions and are classified accordingly;
- Regular maintenance and monitoring of statistical, attendance and benefit reports;
- Utilizing performance measurement tools efficiently, appropriately and in a timely manner;
- Continuing development of a retention strategy for the City, focusing on current labour market issues that will enable us to meet Council's Goals with experienced employees;
- Working proactively with all union groups by actively participating in Joint Consultative Committees;
- Ensuring that negotiations take place in a timely and constructive manner for employment contracts;
- Evaluating and monitoring the Wellness Program;
- Actively promoting the Employee Recognition and Employee and Family Assistance programs;
- Participating in various departmental staff meetings or meetings with managers and directors addressing concerns and issues as requested;
- Promoting the "Open Door" policy of Human Resources so employees can establish a sense of organizational wholeness;
- Communicating with all employees on a regular basis;
- Conducting an orientation program that further enhances employee communication and facilitates the employer-employee bond for new hires;
- Keeping employees apprised of entitlements, cost-saving measures and changes to benefits;
- Providing senior management with quarterly reports on overtime, leave and attendance;
- Providing senior management with semi-annual reports on performance appraisals;
- Managing the training and development budget to ensure that employees have access to opportunities and that training for core competencies and professional development is provided;
- Facilitating increased in-house training programs, including opportunities for audio conferences, and other types of training (i.e. online modules);
- Producing a regular electronic newsletter that is informative for employees and is posted on bulletin boards for those who do not have access to it otherwise;
- Monitoring, updating and auditing the Occupational Safety and Health Program on an annual basis;
- Ensuring employees are aware of safety related training opportunities and encouraging their attendance;
- Managing disability cases jointly with Workers' Safety & Compensation Commission and or the insurance provider, as appropriate;
- Reviewing existing policies and providing revisions that are appropriate to the current workforce;
- Researching, developing and implementing new policies where appropriate.

GENERAL FUND - City Administrator

Human Resources Budget

	2010 Actual (\$000's)	2011 Budget (\$000's)	2011 Forecast (\$000's)	2012 Budget Recommended (\$000's)	2013 Budget (\$000's)	2014 Budget (\$000's)
<b>Revenue</b>						
Grants	2	-	-	-	-	-
	2	-	-	-	-	-
<b>Expenditures (By Activity)</b>						
Payroll & Benefits Administration	241	327	290	292	393	394
Labour Relations	219	226	200	227	231	236
Employee Placement	202	218	193	211	215	220
Employee Development	318	310	275	314	307	301
Occupational Health & Safety	133	138	122	144	139	133
	1,112	1,219	1,080	1,188	1,286	1,284
<b>Net Revenue (Expenditures)</b>	(1,110)	(1,219)	(1,080)	(1,188)	(1,286)	(1,284)
<b>Expenditures (By Object)</b>						
Wages & Benefits	569	648	524	626	721	736
Other O&M	543	571	556	562	565	548
	1,112	1,219	1,080	1,188	1,286	1,284



**GENERAL FUND - City Administrator**

---

**Human Resources Performance Measures**

	<b>Projected 2010</b>	<b>Actual 2010</b>	<b>Projected 2011</b>	<b>Forecasted 2012</b>	<b>Forecasted 2013</b>	<b>Forecasted 2014</b>	<b>Notes</b>
<b>Workload Indicators:</b>							
Recruitment							
No. new hires/promotions/transfers							
Permanent	35	22	25	25	25	25	
Casual/Part-time/Term	90	87	90	90	90	90	
Labour Relations							
No. grievances filed	5	7	10	5	5	5	
No. Joint Consultation Committee meetings held	6	5	6	8	8	8	
Payroll Benefit Administration							
No. T4s issued	385	386	395	400	405	410	
Employment Development							
No. conferences, seminars and training sessions attended by City employees	275	476	350	350	350	350	(1)
Occupational Health & Safety							
No. safety related training workshops	40	27	30	30	30	30	
No. Divisional ("tool box") meetings	125	110	175	175	175	175	
No. OHS meetings	6	6	6	8	8	8	
No. workplace injuries reported	30	29	25	24	23	22	
<b>Efficiency Measures:</b>							
Recruitment							
Cost per new hire	\$3,500	\$7,050	\$3,500	\$3,500	\$3,500	\$3,500	(2)
Labour Relations							
Average no. sick days per employee	6	6	6	5	5	5	
Payroll Benefit Administration							
Average cost to process payroll per employee per pay period	\$2.40	\$2.40	\$2.60	\$2.60	\$2.60	\$2.60	
Average monthly cost to the City to provide employee benefit package	\$115,000	\$120,900	\$127,000	\$133,400	\$140,000	\$147,000	(3)
Employee Development							
Average annual cost of employee development:							
per employee	\$1,300	\$905	\$1,000	\$1,000	\$1,000	\$1,000	
per course	\$900	\$1,570	\$1,200	\$1,200	\$1,200	\$1,200	
Occupational Health & Safety							
No. of "lost time" accidents	7	7	5	4	3	2	

(cont'd...)

Human Resources Performance Measures (continued)

	Projected 2010	Actual 2010	Projected 2011	Forecasted 2012	Forecasted 2013	Forecasted 2014	Notes
<b>Effectiveness Measures:</b>							
Recruitment							
% of vacancies filled internally	40%	45%	40%	40%	40%	40%	
% of vacancies filled by fully qualified candidates	80%	95%	80%	80%	80%	80%	
Labour Relations							
Turnover ratio	20%	14%	15%	15%	15%	15%	
% of grievances settled before arbitration or withdrawn	90%	100%	95%	95%	95%	95%	
Employee Development							
Average no. training opportunities per employee per year	1.5	2.5	2.0	2.0	2.0	2.0	
Occupational Health & Safety							
Comparative analysis of injuries - increase or (decrease)	(5)	6	(6)	(2)	(2)	(2)	(4)

**Notes:**

- (1) Significant increase in in-house training by Safety Officer
- (2) Recruitment of several key positions incurred higher costs in 2010.
- (3) Previous estimates did not take into account merit increases (just negotiated amounts) which result in a higher cost to benefits.
- (4) Number of workplace injuries for current year minus number of workplace injuries for previous year. If the result is negative, it indicates a decrease.



GENERAL FUND - Corporate Services

DEPARTMENT STAFFING

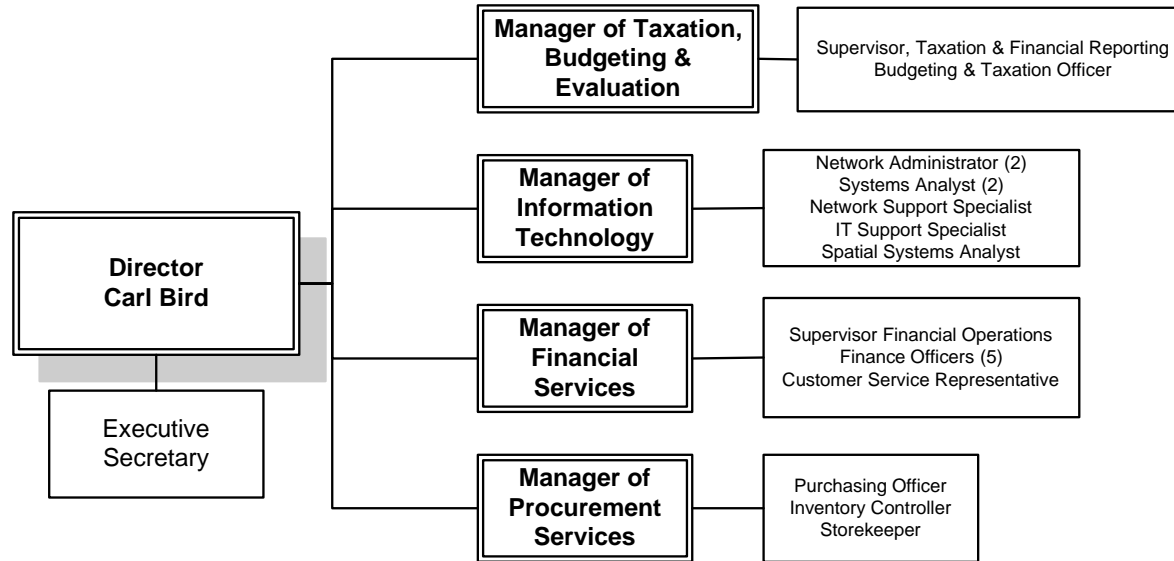

Staffing Summary

	2001 Actual	2002 Actual	2003 Actual	2004 Actual	2005 Actual	2006 Actual	2007 Actual	2008 Actual	2009 Actual	2010 Actual	2011 Actual	2012 Budget	2013 Budget	2014 Budget
Directorate	3.50	3.00	3.00	3.00	3.00	3.00	4.53	4.53	5.00	5.00	5.00	5.00	5.00	5.00
Financial Services				9.96	9.94	9.91	8.38	8.35	8.35	8.35	8.35	8.31	8.31	8.31
Accounting	5.30	5.30	5.30											
Treasury	5.53	5.53	5.53											
Procurement Services	4.00	4.00	4.00	4.00	4.00	4.35	4.00	4.32	4.35	4.00	4.35	4.00	4.35	4.00
Information Technology	5.00	5.00	5.00	6.00	6.00	7.00	7.00	7.00	8.29	8.28	8.00	8.00	8.00	8.00
<b>Total</b>	<b>23.33</b>	<b>22.83</b>	<b>22.83</b>	<b>22.96</b>	<b>22.94</b>	<b>24.26</b>	<b>23.91</b>	<b>24.20</b>	<b>25.99</b>	<b>25.63</b>	<b>25.70</b>	<b>25.31</b>	<b>25.66</b>	<b>25.31</b>
Permanent Positions	23.03	22.53	22.53	22.53	22.53	23.53	23.53	23.53	25.00	25.00	25.00	25.00	25.00	25.00
Part-time/ casual	0.30	0.30	0.30	0.43	0.41	0.73	0.38	0.67	0.99	0.63	0.70	0.31	0.66	0.31
<b>Total</b>	<b>23.33</b>	<b>22.83</b>	<b>22.83</b>	<b>22.96</b>	<b>22.94</b>	<b>24.26</b>	<b>23.91</b>	<b>24.20</b>	<b>25.99</b>	<b>25.63</b>	<b>25.70</b>	<b>25.31</b>	<b>25.66</b>	<b>25.31</b>

### CORPORATE SERVICES DIRECTORATE

The Corporate Services Department is responsible for four service areas: Information Technology; Financial Services; Taxation, Budgeting and Evaluation; and Purchasing and Risk Management. The managers who head each of these divisions report to the director, who sets the course for the department, and provides a level of advice and support to the municipality that is typically associated with the role of chief financial officer. The Directorate Budget includes both the Director's Office and the Taxation, Budgeting and Evaluation Division.

### 2011 Highlights

The highlights of the Corporate Services Directorate include:

- Receipt of the Distinguished Budget Presentation Award from GFOA for the triennial beginning January 1, 2011. In order to receive this award, a government unit must publish a document that meets program criteria as a policy document, an operations guide, a financial plan, and a communication device;
- Property owners and/or lien holders paid off outstanding taxes on 100% of the properties listed on the original 2011 tax auction list;
- Developed a Yellowknife Municipal Price Index to assist in budget development;
- Finalized the Development Incentive By-law;
- Improved the presentation of financial statements as it pertains to the recommendations of the Public Sector Accounting Board for Tangible Capital Asset Accounting and for Financial Statement Presentation;
- Achieved an unqualified audit opinion on the financial statements for the year ending December 31, 2010;
- Received the Canadian Award for Financial Reporting and the Award for Popular Annual Financial Report for the fiscal year ended December 31, 2009;
- Enhanced the quarterly financial reporting process to provide better information to Administration and Council on progress towards Council's goals and objectives.

### 2012/2013/2014 Goals

The Corporate Services Directorate will support the goals of the Corporation as follows:

#### Affordability

- Maintain and provide accurate and timely taxation information so that information needs, both internal and external, are well served;
- Work closely with the City's assessor to produce certified tax rolls as specified in the *Property Assessment and Taxation Act* (PATA);
- Manage the Senior and Disabled Tax Relief programs;
- Define and streamline the tax exemption process for NGOs.

#### Enhancing our Built Environment

- Work closely with Planning and Development on initiatives to increase the City's tax base;
- Work closely with Planning and Development on relationships with the diverse business and residential districts within the City.

#### Building Social Capital (Community Engagement)

- Work closely with the City's lawyer so that the City is following (PATA) when collecting tax arrears and conducting the tax auction;
- Complete the integration of the payroll and financial systems;
- Continue to update the taxation manual.

#### Continuous Improvement

- Provide leadership to all divisions within the Department of Corporate Services;
- Provide timely and reliable financial forecasts to Administration, Audit Committee and Council;
- Provide financial information support to the organization in a manner which is up-to-date and timely so that departments can better manage their budgets and expenditures;
- Continue to improve performance measures as a tool to monitor progress in achieving Council's goals and inform citizens about the effectiveness and efficiency of the City's programs and services.



## GENERAL FUND - Corporate Services

### 2012/2013/2014 Objectives

The following actions will be undertaken to support the goals and objectives outlined above:

- Prepare an audited financial report by May 31, 2012 that qualifies for GFOA'S Canadian Award for Financial Reporting;
- Prepare a multi-year budget document for 2013/2014/2015 that reflects the goals and objectives of Council and qualifies for the Distinguished Budget Presentation Award;
- Finalize a debt management plan;
- Implement the Development Incentive Program;
- Assist Planning and Lands in the marketing of Engle Business District and other commercial and residential developments;
- Working with other departments, resolve the infrastructure issues facing Condominium Corporation #8 (Northlands Mobile Home Park);
- Amend the Tax Administration By-law to clarify the criteria for tax exemption eligibility;
- Amend the Tax Administration By-law to discourage land speculation.

<b>Department Budget</b>		2010	2011	2011	2012	2013	2014
		Actual	Budget	Forecast	Budget	Budget	Budget
		(\$000's)	(\$000's)	(\$000's)	Recommended	(\$000's)	(\$000's)
					(\$000's)		
<b>Revenue</b>							
Grants		-	-	20	-	-	-
User Charges		421	333	403	326	326	326
		421	333	423	326	326	326
<b>Expenditures (By Division)</b>							
Directorate		929	903	924	947	1,002	984
Information Technology		1,692	1,654	1,658	1,721	1,861	1,931
Financial Services		780	818	811	833	858	884
Procurement & Risk Management Services		1,274	1,311	1,315	1,336	1,378	1,388
		4,674	4,686	4,707	4,836	5,098	5,187
<b>Net Revenue (Expenditures)</b>		(4,253)	(4,353)	(4,285)	(4,510)	(4,772)	(4,861)
<b>Expenditures (By Object)</b>							
Wages & Benefits		2,620	2,774	2,676	2,804	2,928	3,012
Other O&M		2,054	1,912	2,031	2,032	2,170	2,175
		4,674	4,686	4,707	4,836	5,098	5,187



## GENERAL FUND - Corporate Services

### Directorate Budget

	2010 Actual (\$000's)	2011 Budget (\$000's)	2011 Forecast (\$000's)	2012 Budget Recommended (\$000's)	2013 Budget (\$000's)	2014 Budget (\$000's)	Note
<b>Revenue</b>							
Grants	-	-	20	-	-	-	
User Charges	190	125	125	125	125	125	(1)
	190	125	145	125	125	125	
<b>Expenditures (By Activity)</b>							
Labour Relations	13	13	13	14	14	14	
Legislation & Governance	201	165	169	173	183	180	
Property Assessment	215	315	323	331	350	344	(1)
Financial Reporting & Analysis	500	410	419	430	455	447	
	929	903	924	947	1,002	984	
<b>Net Revenue (Expenditures)</b>	(739)	(778)	(779)	(822)	(877)	(859)	
<b>Expenditures (By Object)</b>							
Wages & Benefits	610	624	624	636	653	670	
Other O&M	319	279	300	311	349	314	
	929	903	924	947	1,002	984	

### Note

(1) The City has signed the assessment authority agreement with GNWT until May 31, 2014.



### INFORMATION TECHNOLOGY DIVISION

The Information Technology Division is responsible for all aspects of the City's information technology infrastructure. This includes:

- the secure and reliable network that connects workstations, laptops, mobile devices, printers and scanners at sites throughout the City and provides users with access to essential software tools, integrated data sources, and the internet;
- databases that house and protect extensive data collections across the corporation;
- software applications that streamline processes and services;
- websites that extend electronic information access and online services to staff and citizens;
- telephone, cellphone, voice mail, and handheld devices that facilitate efficient communications;
- public workstations and wireless services that expand public computing and Internet access;
- back-end systems that support diverse services such as traffic lights, ice-making equipment, building controls, digital call logging, and security cameras.

#### 2011 Highlights

The highlights of the Information Technology Division include:

- Sustaining efforts to protect the City's information technology infrastructure, including:
  - Implementing upgrades to the network infrastructure and server base to provide increased security, capacity, reliability and availability to meet growing demands;
  - Providing ongoing maintenance of anti-spam, anti-virus, and web content filtering services to protect the infrastructure;
  - Coordinating major software upgrades to provide effective tools for operations throughout the organization.
  - Managing ongoing hardware renewals to provide staff with appropriate tools at minimum cost;
  - Continuing with the creation of a secondary site to protect the City's investment and operations.
- Expanding and enhancing cityExplorer, by:

- Adding new information, including known archaeological sites, hydrants, contours, sidewalk clearing information, and General Plan layers.
- Creating a customized site to provide the Fire Division with mission-critical information en route to incidents.
- Redesigning reporting processes and formats to provide more meaningful information to senior management.
- Providing technical support and assistance for the One-Stop Shopping initiative.
- Integrating multiple network management tools to provide granular insight into the City's network, and to advance towards a proactive and predictive approach to network management.
- Expanding server virtualization as a greener, more efficient operational paradigm, and piloting desktop virtualization.
- Expanding mobile computing capabilities by deploying additional computers and laptops in public service vehicles.
- Installing additional security cameras in City facilities to protect the City's citizens, staff, and property, and deploying more full-featured and robust back-end software to enhance video collection, storage, and retrieval capabilities.
- Coordinating the multi-year Communications Infrastructure initiative.

#### 2012/2013/2014 Goals

The goals of the Information Technology Division are to:

- Provide focused and reliable information technology infrastructure that is responsive to current City requirements and proactive in anticipation of future requirements.
- Provide secure, high availability network services.
- Support the efficient and effective operation of all information systems.
- Supply technical leadership and support for ongoing information technology projects within the civic organization.

#### 2012/2013/2014 Objectives

The objectives of the Information Technology Division are to:

- Supply ongoing leadership to support and sustain the City's information technology infrastructure.

## GENERAL FUND - Corporate Services

---

- Provide City employees with the appropriate hardware and software tools to enable them to do their jobs efficiently and effectively, including:
  - Acquiring and deploying new and replacement information technology equipment in a timely and cost-effective manner,
  - Supporting, upgrading, and maintaining the City's corporate and desktop software applications.
  - Providing prompt and knowledgeable responses to client issues and requests for assistance.
  - Assisting client departments in reviewing and refining processes and procedures to ensure they are obtaining maximum benefit from existing systems.
  - Encouraging clients to become more independent in their use of information technology resources in order to increase their efficiency and effectiveness and improve their levels of satisfaction with their tasks.
  - Providing clients with additional tools and resources to enable them to better utilize the City's information technology infrastructure.
- Enhance the capabilities of cityExplorer and expand its use throughout the organization and among the citizens of Yellowknife by developing further integrations with existing applications and data, responding to client feedback and requests in a structured manner, and adhering to industry-standard practices for collecting and maintaining data.
- Provide technical and educational support and effective email management tools to expand compliance with the City's document management policies.
- Embrace a centralized computing paradigm to provide a greener and more manageable approach to service provision.
- Grow mobile workforce opportunities to improve employee efficiency and provide more effective service delivery.
- Adopt increasingly stringent industry-standard security and data protection policies and procedures.
- Maintain and enhance infrastructure, inventory, and knowledge base documentation.
- Provide proactive support for the One-Stop Shopping initiative.
- Conclude the Communications Infrastructure implementation, and champion the initiative to encourage clients to utilize the features to expand and enhance mobile service delivery.
- Complete a secondary site to support business continuity and disaster recovery.
- Effectively manage all information technology capital projects, including:
  - Expanding the implementation of security cameras throughout the city to protect citizens, staff, and property.
  - Expanding electronic meeting management and providing real-time and archived webcasts of Council meetings.
  - Upgrading the electrical and cooling systems and backup power capacity in the server room.
  - Implementing a Citizen Request Management system to effectively track, route, and manage all citizen inquiries and requests.
  - Building transparent and accountable network visibility, management and reporting.
  - Deploying automated ticket writing and data capture capabilities.
  - Automating the permit application and approval process.
  - Introducing a spatial-based asset management tool.
  - Implementing a status keeping solution for Municipal Enforcement staff.



GENERAL FUND - Corporate Services

Information Technology Budget		2010 Actual (\$000's)	2011 Budget (\$000's)	2011 Forecast (\$000's)	2012 Budget Recommended (\$000's)	2013 Budget (\$000's)	2014 Budget (\$000's)
<b>Revenue</b>							
	User Charges	3	-	2	-	-	-
		3	-	2	-	-	-
<b>Expenditures (By Activity)</b>							
	Maintenance	880	862	864	887	1,018	1,034
	Installation	188	176	176	191	187	206
	Training & Support	482	478	479	497	510	533
	System Development	141	139	139	147	146	158
		1,692	1,654	1,658	1,721	1,861	1,931
<b>Net Revenue (Expenditures)</b>		(1,689)	(1,654)	(1,657)	(1,721)	(1,861)	(1,931)
<b>Expenditures (By Object)</b>							
	Wages & Benefits	961	1,017	991	1,027	1,072	1,109
	Other O&M	731	637	667	694	789	822
		1,692	1,654	1,658	1,721	1,861	1,931

## GENERAL FUND - Corporate Services

### Information Technology Performance Measures

	Projected 2010	Actual 2010	Projected 2011	Forecasted 2012	Forecasted 2013	Forecasted 2014	Notes
<b>Workload Indicators</b>							
No. of IT staff	8	8	8	8	8	8	(1)
No. of servers	26	32	52	52	52	57	(2)
Physical		27	32	29	25	25	
Virtual		5	20	23	27	32	
No. of client workstations	146	135	135	137	139	141	(3)
No. of public access workstations	8	8	12	12	12	12	
No. of laptops	36	35	51	56	62	66	(4)
Administration	11	10	21	23	25	27	
Elected Officials	10	10	10	10	10	10	
Dedicated	7	7	12	15	19	21	
Loaners	6	6	6	6	6	6	
iPads	2	2	2	2	2	2	
No. of handhelds	30	29	35	40	45	50	(5)
No. of cell phones	46	54	50	52	52	50	
No. of scanners	32	32	33	34	35	36	
No. of special purpose computer systems	41	41	43	43	43	43	
No. of security cameras	37	37	43	48	53	58	
No. of applications supported	243	274	341	346	343	343	(6)
Desktop (core)	16	20	19	19	19	19	
Desktop (specialized)	122	145	213	217	215	215	
Diamond/eEnterprise	46	46	46	48	48	48	
Class	11	11	13	13	13	13	
FDM	7	7	7	7	7	7	
GeoWare	13	14	14	14	14	14	
IVR	3	3	2	2	2	2	
Web	20	21	19	19	19	19	
Operating Systems	5	7	8	7	6	6	
No. of work orders opened	4,424	4,424	4,908	5,153	5,411	5,682	
No. of work orders closed	4,364	4,364	4,857	5,099	5,354	5,622	
% of work orders closed	99%	99%	99%	99%	99%	99%	
No. of web site visitors (City)	319,075	328,653	373,497	373,497	373,497	373,497	
No. of page views (City)	4,174,133	4,902,110	4,547,065	4,972,048	4,972,048	4,972,048	(cont'd...)



**GENERAL FUND - Corporate Services**

---

**Information Technology Performance Measures (cont'd)**

	<b>Projected 2010</b>	<b>Actual 2010</b>	<b>Projected 2011</b>	<b>Forecasted 2012</b>	<b>Forecasted 2013</b>	<b>Forecasted 2014</b>	<b>Notes</b>
<b>Efficiency Measures</b>							
Average infrastructure cost per user (desktop/laptop)	\$3,396	\$3,645	\$3,362	\$3,426	\$3,576	\$3,642	(7)
Average infrastructure cost per client device	\$1,926	\$2,215	\$2,106	\$2,122	\$2,208	\$2,247	
Average support cost per user	\$3,929	\$4,343	\$3,899	\$4,097	\$4,264	\$4,285	(7)
Average support cost per client device	\$2,807	\$2,962	\$2,728	\$2,828	\$2,930	\$2,942	
<b>Effectiveness Measures</b>							
% of users receiving updated PC	26%	28%	25%	25%	25%	25%	(8)
Web site visitors per day (City)	874	900	1,023	1,023	1,023	1,023	
Informational Site	821	845	955	955	955	955	
eBusiness	24	25	29	29	29	29	
eConnect	29	31	39	39	39	39	
Web site visits per day (City)	1,735	1,936	2,677	2,677	2,677	2,677	
Informational Site	1,648	1,844	2,554	2,554	2,554	2,554	
eBusiness	38	38	47	47	47	47	
eConnect	49	53	77	77	77	77	

**Notes:**

- (1) The plan to amalgamate GIS functionality under IT as an interim step to establishing a corporate GIS function was not realized.
- (2) The definition of "Server" is evolving as the City moves to a more virtualized environment.
- (3) The number of client workstations did not increase as quickly as envisioned due to an anticipated increase in the demand for laptops.
- (4) The number of laptops grew more quickly than expected because of relaxed approval processes.
- (5) The number of handhelds (Blackberries) grew more quickly than expected because of relaxed approval processes.
- (6) The number of supported applications grew rapidly due to vendor re-packaging and client acquisitions.
- (7) Starting in 2010, more staff time and effort will be allocated to user support.
- (8) Based on the City's four-year evergreening cycle.

### FINANCIAL SERVICES DIVISION

The Financial Services Division is responsible for the utilities, accounting, and lottery licensing functions in accordance with established legislation and by-laws. The employees in this division track and report the City's revenues, expenditures, assets and liabilities. They also provide customer service and information to the public on a wide range of issues.

#### 2011 Highlights

The highlights of the Financial Services Division include:

- Amalgamation of the reception, front counter and business licenses and permits duties into a single customer service access point;
- Involvement of staff in cross-training sessions to ensure continuity of workflow in the event of prolonged absences;
- Implementation of a tangible capital assets inventory tool to track acquisition, betterment and disposal events and identify capital replacement requirements;
- Movement toward a more cost-effective and environmentally responsible accounts payable function, as demonstrated by an increase of electronic funds transfer payments from 1189 in 2010 to a projected 1,300 in 2011;
- Implementation of a system of consolidated bank deposits, reducing staff time, paper and processing costs;
- Reduction of external collection costs, resulting in a projected 100% recovery of collection costs for 2011;
- Coordination with Public Works Water and Sewer division to purchase meter readers capable of direct download to financial software.

#### 2012/2013/2014 Goals

The goals of the Financial Services Division are to:

- Continue to provide courteous and helpful assistance to customers and improve access to City financial services;
- Continue to improve the internal controls within the division;
- Improve the administration of Lottery By-law No. 4092;
- Continue to safeguard and manage the City's financial resources

- prudently;
- Continue to maintain accurate and timely financial records in accordance with generally accepted accounting principles, such that the needs for financial information, both internally and externally are well served;
- Control City-owned tangible capital assets on a real-time basis ;
- Centralize the management of funding agreements;
- Diligently continue to collect outstanding amounts owed to the City.

#### 2012/2013/2014 Objectives

The objectives of the Financial Services Division are to:

- Continue to develop and improve sound financial procedures for the utilities, accounts receivable, accounts payable and cash receipt functions to improve customer service, facilitate training of staff and streamline processes between departments;
- Introduce a paperless billing option for Utilities and A/R customers;
- Take advantage of automation capability of A/P Visa statement processing;
- Integrate utilities meter readings with financial systems;
- Create a register for grant applications and funding agreements and track events of each;
- Continue involvement of staff in training and cross-training sessions on financial procedures;
- Continue to support integration of financial systems with work management software;
- Maintain transaction procedures conforming to current Payment Card Industry standards.



**GENERAL FUND - Corporate Services**

---

**Financial Services Budget**

	2010 Actual (\$000's)	2011 Budget (\$000's)	2011 Forecast (\$000's)	2012 Budget Recommended (\$000's)	2013 Budget (\$000's)	2014 Budget (\$000's)
<b>Revenue</b>						
User Charges	186	208	187	201	201	201
	<u>186</u>	<u>208</u>	<u>187</u>	<u>201</u>	<u>201</u>	<u>201</u>
<b>Expenditures (By Activity)</b>						
Cash Receipts & Collections	192	204	202	149	153	158
Cash Management	53	55	55	124	129	134
Customer Invoicing	136	141	139	193	194	195
Financial Analysis and Reporting	221	231	229	185	192	200
Lottery Licensing	21	22	21	14	15	15
Public Information/Inquiry	81	86	85	80	83	86
Vendor Payments	77	80	79	88	91	95
	<u>780</u>	<u>818</u>	<u>811</u>	<u>833</u>	<u>858</u>	<u>884</u>
<b>Net Revenue (Expenditures)</b>	<u>(594)</u>	<u>(610)</u>	<u>(624)</u>	<u>(632)</u>	<u>(657)</u>	<u>(683)</u>
<b>Expenditures (By Object)</b>						
Wages & Benefits	662	715	646	724	754	785
Other O&M	118	103	165	109	104	99
	<u>780</u>	<u>818</u>	<u>811</u>	<u>833</u>	<u>858</u>	<u>884</u>



## GENERAL FUND - Corporate Services

### Financial Services Performance Measures

	Projected 2010	Actual 2010	Projected 2011	Forecasted 2012	Forecasted 2013	Forecasted 2014	Notes
<b><u>Workload Indicators:</u></b>							
<b>Accounts Payable and Disbursements</b>							
No. of accounts payable invoices processed	11,077	12,384	11,605	12,000	12,000	12,000	
No. of Visa card transactions processed	5,469	6,457	5,884	6,500	6,500	6,500	
No. of Visa card disbursements	12	12	12	12	12	12	
No. of electronic fund transfer disbursements	1,142	1,162	1,186	1,250	1,250	1,250	
No. of accounts payable cheques issued	2,262	2,197	1,788	1,800	1,800	1,800	
<b>Cash Receipt and Collections</b>							
No. of cash receipts issued	45,550	48,591	52,688	53,000	53,500	54,000	
<b>Customer Invoicing</b>							
No. of utility customer accounts	5,300	5,273	5,300	5,350	5,400	5,450	
No. of tax customer accounts	5,156	5,253	5,300	5,400	5,450	5,500	
No. of tax certificates issued	700	612	573	600	600	600	
No. of accounts receivable invoices processed	10,000	9,568	10,332	10,500	11,000	11,500	
<b>Financial Analysis and Reporting</b>							
No. of annual reports printed	7,900	1,000	1,000	1,000	1,000	1,000	(1)
<b>Lottery Licensing</b>							
No. of lottery licences issued	259	259	280	280	280	280	
<b><u>Efficiency Measures:</u></b>							
<b>Accounts Payable and Disbursements</b>							
Cost per procurement transaction							
- Visa	\$2.97	\$2.97	\$3.06	\$3.15	\$3.25	\$3.35	(2)
- Electronic funds transfer	\$2.81	\$2.81	\$2.88	\$2.96	\$3.04	\$3.13	(2)
- Cheques	\$3.92	\$3.92	\$4.08	\$4.18	\$4.29	\$4.43	(2)
<b>Customer Invoicing</b>							
Cost to process and mail a utility invoice	\$1.14	\$1.14	\$1.22	\$1.22	\$1.24	\$1.25	
Cash conversion cycle (No. of days)	50	50	50	50	50	50	
<b>Financial Analysis and Reporting</b>							
Cost to produce the annual report	\$25,677	\$25,767	\$21,500	\$9,000	\$9,000	\$9,000	(1)

Cont'd..



## GENERAL FUND - Corporate Services

---

### Financial Services Performance Measures (cont'd)

	Projected 2010	Actual 2010	Projected 2011	Forecasted 2012	Forecasted 2013	Forecasted 2014	Notes
<b><u>Effectiveness Measures:</u></b>							
<b>Accounts Payable and Disbursements</b>							
No. of A/P invoices paid more than 30 days after statement date	250	298	332	300	300	300	
<b>Cash Management</b>							
Average rate of return on investments	1.01%	1.45%	1.37%	1.5%	3%	3%	
No. of days positive cash balance	365	365	365	365	365	365	
<b>Cash Receipts and Collections</b>							
Average days revenue outstanding							
Tax (net 60 days)	120	148	150	120	120	120	
Utility (net 21 days)	72	52	58	60	60	60	
Other (net 30 days) - not including land sales	91	95	72	90	90	90	
No. of utility accounts balances transferred to taxes	250	268	250	250	250	250	
No. of tax/utility accounts using pre-authorized payment services	3,428	3,332	3,572	3,600	3,650	3,700	(3)
<b>Financial Analysis and Reporting</b>							
Avg. no. of days reconciliations completed late	30	30	30	30	30	30	
<b>Lottery Licensing</b>							
No. of lottery statements outstanding	10	23	10	10	10	10	

**Notes:**

- (1) Reduced hard copy distribution of Annual Reports beginning in 2011; in-house production beginning in 2012
- (2) Actual 2008 and forward: cost for disbursement only; assumes same procurement cost for all methods
- (3) Pre-authorized direct debit payments on tax accounts increased in 2010 - credit card payments no longer accepted.

### PROCUREMENT SERVICES DIVISION

The Procurement Services Division is responsible for purchasing, insurance claims and coverage, and the operation of City Stores where the City's inventory is warehoused and managed. The insurance work involves communicating claims and coverage information between the City's insurers and the user departments. Purchasing tasks include coordinating the procurement of goods and services for City departments through the issuance of tenders, requests for proposals (RFPs), purchase orders, or inventory.

#### 2011 Highlights

The highlights of the Procurement Services Division include:

- Performed perpetual enumerations which made it possible to correct multiple minor inaccuracies with quantity, description, maximum/minimum and order vendor information
- Fully re-organized the storage shed to create more space
- Applied barcodes on inventory items in preparation for barcode upgrade (late 2011) which will help achieve efficiencies in issue, receiving and enumeration process time
- Worked with the GNWT on waste oil regulatory inspection concerns. During this process, staff had to turn off the heat in the storage shed for most of the winter, which meant chemicals needed to be moved into the main storage area where they would not freeze. The issue was rectified after it was discovered that the lab performing the tests were providing inaccurate results.
- Several clean-up projects and painting were completed by the summer casual employee. Also the City's fleet VIN numbers were verified against information that was to be provided to the City's insurer.
- Three staff received forklift re-training and certification.
- Replaced rotten cribbing in compound which was then graded for proper drainage and packed.
- Assisted with and procured goods and services for the 2011 Royal Visit.
- Participated in the re-design and purchase of new furniture for the Municipal Enforcement Division, and the Administration and foyer areas of City Hall resulting in more functional and ergonomically appropriate work spaces.

- Worked with the Safety Officer to create a contractors' safety information sheet which is now included in applicable bidding documents.
- Set up training for managers/supervisors on our insurance program which allowed the City to realize the full benefits of the rebates offered by our insurance provider.

#### 2012/2013/2014 Goals

The goals of the Procurement Services Division are to:

- Contribute to the well-being of the City's financial position through efficient and responsive materiel management, including acquisitions, inventory, storage, distribution, and disposal.
- Administer claims and ensure the City's interests are looked after by working closely with the City's insurers, adjusters and insurance brokers, while ensuring fair treatment of claimants.
- Provide expertise and guidance in the procurement of both operational and capital budget items.
- Participate as corporate team members in identifying and developing good supplier partnerships, and in providing excellent customer service to both internal and external customers.

#### 2012/2013/2014 Objectives

The objectives of the Procurement Services Division are to:

- Install an insulated dropped ceiling in the storage shed which will help increase insulation value and reduce heating costs.
- replace incandescent lights with fluorescent ones, reducing electrical consumption by approximately two-thirds.
- Establish and maintain a one-month pre-drawn filter system for the fleet, reducing mechanics' downtime while waiting for filters to be collected.
- Prepare approved assets for a spring auction.
- Finish painting in the warehouse area of City Stores.
- Work with the City of Yellowknife's procurement card provider to better utilize the card program and provide cost/time savings to the City and its employees.



**GENERAL FUND - Corporate Services**

---

- Be more 'green' in procurement of goods and services wherever possible.
- Seek out educational opportunities for divisional employees.
- Update the City's various contracts via legal review.
- Schedule involvement in capital purchases with departments so that projects can be looked after in a timely manner that meets the schedules of the various departments.
- Review online requisitioning and take first steps toward potential future implementation.
- Enter into a Standing Offer Agreement with airlines for flights between Yellowknife and Edmonton for staff travel, both business and personal.
- Assist with conversion to the 'One-Stop Shopping' initiative at City Hall and the planned future renovation of the building.

**Procurement Services Budget**

	2010 Actual (\$000's)	2011 Budget (\$000's)	2011 Forecast (\$000's)	2012 Budget Recommended (\$000's)	2013 Budget (\$000's)	2014 Budget (\$000's)
<b>Revenue</b>						
User Charges	42	-	89	-	-	-
	42	-	89	-	-	-
<b>Expenditures (By Activity)</b>						
Materiel Purchasing	204	217	217	216	231	231
Inventory Management	143	155	155	151	165	162
Risk Management	729	745	748	763	772	781
Common costs	197	194	195	205	210	214
	1,274	1,311	1,315	1,336	1,378	1,388
<b>Net Revenue (Expenditures)</b>	(1,232)	(1,311)	(1,226)	(1,336)	(1,378)	(1,388)
<b>Expenditures (By Object)</b>						
Wages & Benefits	388	418	416	417	449	448
Other O&M	886	892	899	919	929	940
	1,274	1,311	1,315	1,336	1,378	1,388

## GENERAL FUND - Corporate Services

### Procurement Services Performance Measures

	Projected 2010	Actual 2010	Projected 2011	Forecasted 2012	Forecasted 2013	Forecasted 2014	Notes
<b>Workload Indicators</b>							
Inventory							
Issuances	5,000	5,496	5,400	5,500	5,400	5,500	
Inventory line items received	900	856	800	850	825	850	
Year-end inventory value (000s)	410	413	420	425	440	450	
Procurement							
Number of purchase orders issued	400	340	350	360	375	380	
Procurement card transactions (PCT)	7,500	7,558	8,000	9,350	10,285	11,300	(1)
Value of PCT (000s)	1,750	1,613	1,775	2,090	2,300	2,530	(1)
Number of cards issued	95	85	85	85	95	95	
Risk Management							
Number of insurance incidents	18	15	20	20	20	20	(2)
Number of incidents turning into claims	5	6	10	10	10	10	
<b>Efficiency Measures</b>							
Inventory							
Annual inventory turnover	2.5	2.1	2.2	2.3	2.3	2.4	
% of inventory line items received and stored within 2 working days	90%	80%	85%	90%	95%	95%	
<b>Effectiveness Measures</b>							
Procurement							
% of goods/services purchased through the Procurement Division	85%	85%	85%	85%	85%	85%	
% of goods/services purchased locally	85%	85%	85%	85%	85%	85%	

#### Notes:

- (1) Procurement card transactions and values may increase as we move toward automation in the next year or two.
- (2) Insurance claims are very difficult to predict. These can vary drastically from year to year and we have little control over the variables which affect them.



GENERAL FUND - Economic Development

DEPARTMENT STAFFING

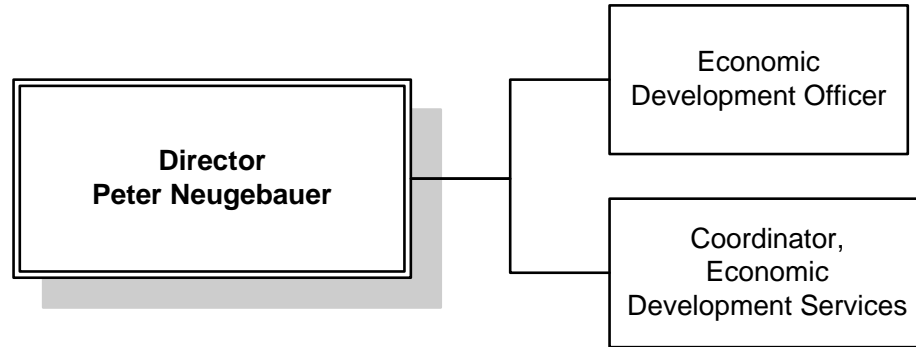

Staffing Summary

	2001 Actual	2002 Actual	2003 Actual	2004 Actual	2005 Actual	2006 Actual	2007 Actual	2008 Actual	2009 Actual	2010 Actual	2011 Actual	2012 Budget	2013 Budget	2014 Budget
Directorate	3.00	3.30	3.30	3.30	3.30	3.30	3.30	3.30	3.30	3.30	3.30	3.25	3.25	3.25
	3.00	3.30	3.30	3.30	3.30	3.30	3.30	3.30	3.30	3.30	3.30	3.25	3.25	3.25
Permanent Positions	0.00	3.00	3.00	3.00	3.00	3.00	3.00	3.00	3.00	3.00	3.00	3.00	3.00	3.00
Casual/part-time		0.30	0.30	0.30	0.30	0.30	0.30	0.30	0.30	0.30	0.30	0.25	0.25	0.25
Term	3.00													
	3.00	3.30	3.30	3.30	3.30	3.30	3.30	3.30	3.30	3.30	3.30	3.25	3.25	3.25

### ECONOMIC DEVELOPMENT DEPARTMENT

The department's goal is sustainable growth that does not add to infrastructure and service costs. The department supports partnerships and initiatives that contribute to a diverse and vibrant local and regional economy, attract investment to Yellowknife and the NWT, and encourage new businesses and residents to join our growing and prosperous community.

Our programs include: Attract Business and Family Relocation; Canadian Capital Cities Organization; Diamond Capital of North America™; Tourism Marketing and Development; Minerals, Oil and Gas Development; Research, Planning and Program Development.

### 2011 Highlights

The 2011 highlights of the Economic Development Department include:

- Coordinated with the NWT Film Commission to provide ongoing assistance and support to Arctic Air Productions Ltd. which is filming a dramatic series based in Yellowknife that will air on CBC in 2012.
- Collaborated with the GNWT and private sector partners to encourage the development of a diamond tourist centre in the downtown core. It is anticipated the centre will open in early 2012.
- Partnered with NWT Tourism and industry partners to develop displays and marketing material to profile Yellowknife's aurora viewing and diamond industry during Aurora Week in Tokyo, Japan, and other offshore venues.
- Continue to support activities that promote and profile Ice Road Truckers and Ice Pilots NWT.
- Continued promotion and coordination with the GNWT to promote Yellowknife and the NWT through their Come Make Your Mark campaign.
- Participation and promotion of the Canadian Geographic photo contest. The contest, which was a joint partnership between the Canadian Capital Cities Organization and Canadian Geographic, involves a travelling exhibit of the winning photographs from each capital city.
- Participation in research and promotional activities related to Canadian capital cities involvement in Canada 150: Connecting Canadians and Celebrating Canada. The celebration of Canada's 150<sup>th</sup> birthday takes place in 2017. CCCO is considering promotional opportunities for capital cities leading up to and including the 2017 celebration.
- Secured funding from the GNWT to continue hosting diamond cutting and polishing demonstrations at the Northern Frontier Visitors Centre.
- Support and sponsorship of the Deh Cho Connection – Diamonds in the Rough Passport Program. Visitors with a fully-stamped passport are eligible to win a Government Certified Canadian Diamond™ that was mined, cut and polished in the NWT.
- Purchased street banners to promote and profile the Diamond Capital of North America™.
- Coordinated with governments and private sector partners to support the secondary diamond industry and product development that link diamonds and tourism.
- Continued support for the development of a public market in conjunction with key events in Old Town/Latham Island area, such as the Old Town Ramble and Ride.
- Participated in the convention bureau and events/festival coordination activities that enhance and promote Yellowknife as the Diamond Capital of North America™.
- Collaborated with the Yellowknife Hotel Association and the GNWT to develop legislation that would enable individual NWT municipalities to decide whether to adopt a hotel room levy. The revenue raised from the levy would be used to spur business travel through marketing to the meetings and conventions market.
- Provided promotional material and displays to support a local tour operator participating in Chinese travel trade shows that will encourage Chinese visitation to Yellowknife and the NWT.
- Supported initiatives and community partnerships that raised the profile of the City and strengthened business development and tourism opportunities. Local events and activities include, but are not limited to: Old Town Ramble and Ride; NWT Music Cabin Fever Festival; NWT Tourism Annual General Meeting; Geoscience Forum; National Aboriginal Capital Corporation Association; Wedding Mini-Trade Show; Angler/Young Angler Fishing Tournament.



## GENERAL FUND - Economic Development

---

### 2012/2013/2014 Goals:

The goals of the Economic Development Department are aligned with Council's Goals #1, #3 and #4:

- #1 Affordability
- #2 Building Social Capital (Community Engagement)
- #4 Continuous Improvement

### 2012/2013/2014 Objectives:

The objectives of the Economic Development Department include:

- In collaboration with the NWT Film Commission, government agencies and the private sector, continue to support and encourage film-related activity in Yellowknife and the NWT.
- Continue to work with the Yellowknife Hotel Association, the GNWT and non-government agencies to identify funding to establish a marketing and convention program.
- Continued promotion and coordination with the GNWT to promote Yellowknife and the NWT through their Come Make Your Mark campaign.
- Support the Conseil de développement économique des Territoires du Nord-Ouest (CDÉTNO) to encourage and welcome newcomers to Yellowknife and the NWT.
- Continue to work with the GNWT and private sector to develop and promote diamond tourism opportunities in Yellowknife and the NWT.



## GENERAL FUND - Economic Development

### Department Budget

	2010 Actual (\$000's)	2011 Budget (\$000's)	2011 Forecast (\$000's)	2012 Budget Recommended (\$000's)	2013 Budget (\$000's)	2014 Budget (\$000's)
<b>Revenue</b>						
Government Transfers						
Other Grants	70	60	60	60	60	60
	<u>70</u>	<u>60</u>	<u>60</u>	<u>60</u>	<u>60</u>	<u>60</u>
<b>Expenditures (By Activity)</b>						
Attract Business and Family Relocation	77	80	82	82	83	85
Canadian Capital Cities	27	29	29	29	30	30
Community Partnerships	91	84	86	86	87	89
Diamond Capital of North America	77	80	82	82	83	85
Minerals, Oil and Gas Development	50	52	53	53	54	55
Research Planning and Program Development	69	70	72	72	73	75
Service Contract - NFVA	88	86	88	87	89	91
Tourism Marketing Plan	124	130	132	132	135	138
	<u>601</u>	<u>611</u>	<u>623</u>	<u>620</u>	<u>634</u>	<u>648</u>
<b>Net Revenue (Expenditures)</b>	<u>(531)</u>	<u>(551)</u>	<u>(563)</u>	<u>(560)</u>	<u>(574)</u>	<u>(588)</u>
<b>Expenditures (By Object)</b>						
Wages & Benefits	360	360	372	371	381	391
Other O&M	241	251	251	249	253	257
	<u>601</u>	<u>611</u>	<u>623</u>	<u>620</u>	<u>634</u>	<u>648</u>



### Economic Development Performance Measures

It is a challenge to measure the direct effects of our marketing, public relations, and promotional activities. Ideally, the Department of Economic Development's efforts and expenditures are undertaken in conjunction with other orders of government, trade and commerce organizations, and special interest groups. This method helps us achieve maximum benefit and impact, and minimize costs. Our role is often facilitation and niche filling. Partnerships and joint ventures are preferred initiatives.

For these reasons, direct net performance can be difficult to identify and isolate. Therefore, a reliance on big picture economic indicators and performance measures is often necessary. Available measures include:

- Inquiry, contact, and participation statistics, as well as mail-out and other fulfillment collected by the City's Economic Development Department.
- Northern Frontier Visitors Association and tourism operators maintain visitation data and, from time to time, the GNWT prepares visitor exit survey reports.
- The City's development permits, building permits, business license, taxation and utility records are indicators of economic development and business activity within the community.
- Benchmarks provided by Canada Mortgage and Housing Corporation, Statistics Canada (the Consumer Price Index), NWT Bureau of Statistics (Statistics Quarterly).

Economic initiatives usually develop over a period of time and may not have strictly defined input/output indicators. Measurable patterns are less structured and are often interrupted. However, individual program performance measures may include, but are not limited to:

#### **Canadian Capital Cities Organization (CCCO)**

The Department of Economic Development occupies the seat for the City of Yellowknife on the CCCO Board of Directors.

Representatives combine their efforts to promote the 14 capitals of Canada in terms of cultural, historical, and economic prospects. Best practice exchanges among the capital cities can result in cost saving and economies of scale.

#### **Attract Business and Family Relocation**

Program measurements can be based on housing and business statistics, new business licenses, business expansions, big box and national chain start-ups, fulfillment and inquiries.

The Department of Economic Development produces and distributes the Yellowknife Community Profile. The Community Profile is updated and revised biannually. Copies are available on the City's website and through the Department of Economic Development.

**City of Yellowknife  
Building Inspection Permits & Value - 10 Year Comparison**

	2002	2003	2004	2005	2006	2007	2008	2009	2010	2011 YTD
<b>Permits</b>										
<b>Residential</b>	437	628	364	360	432	340	506	497	553	571
<b>Commercial</b>	135	187	96	133	161	154	151	162	144	145
<b>Value (\$)</b>										
<b>Residential</b>	44,284,954	44,897,392	14,304,551	13,848,638	19,753,334	20,344,243	24,346,293	11,003,908	25,277,908	34,835,773
<b>Commercial</b>	31,363,595	39,620,068	13,733,130	16,920,064	18,688,224	73,577,393	40,789,213	52,885,057	29,087,362	13,444,629

**City of Yellowknife  
New Business Licence Report - 5 Year Comparison**

	Commercial	Home	Non-Resident	*Combined	**Total YTD Active Business Licenses
<b>2007</b>	70	119	25	189	1,528
<b>2008</b>	122	235	26	357	1,776
<b>2009</b>	70	135	28	205	1,563
<b>2010</b>	28	47	21	75	1,542
<b>2011</b>	63	124	19	187	1,678

\* Combined new licence statistics include new home and commercial business licences issued in the year identified. These numbers do not include renewals.

\*\* YTD Active includes total new licences issued plus renewals for the year identified.



## GENERAL FUND - Economic Development

The Department maintains an inquiry/fulfillment summary. The summary tracks recruitment, relocation, business and tourism inquiries, which are effective statistics for determining current market trends. The Department fulfills annual requests for recruitment/relocation packages from several organizations, including: Stanton Territorial Hospital, GNWT Department of Health and Social Services, mining/resource developers, GNWT Department of Education, Culture and Employment, aurora tourism operators, RCMP G Division, Joint Task Force North, and Aurora College.

The following table provides a summary of inquiry and fulfillment requirements.

City of Yellowknife Inquiry/Fulfillment Summary - 5-Year Comparison					
	2007	2008	2009	2010	2011
January	457	788	1,627	3,527	558
February	586	630	3,055	1,251	2,454
March	2,369	1,537	2,807	1,040	808
April	246	818	1,735	549	858
May	921	424	127	1,490	950
June	249	907	1,221	559	1,988
July	972	445	458	411	1,773
August	681	878	749	961	1,840
September	929	1,404	669	1,476	1,684
October	3,762	323	375	1,009	2,367
November	239	1,418	3,082	2,372	486
December	208	187	12	333	252
<b>TOTAL</b>	<b>11,619</b>	<b>9,759</b>	<b>15,917</b>	<b>14,978</b>	<b>16,018</b>

The Northern Frontier Visitors Centre provides additional recruitment and relocation packages.

Northern Frontier Visitors Centre Relocation/Recruitment Fulfillment - 5-Year Comparison					
	2007	2008	2009	2010	2011
Recruitment	40	0	200	10	0
Relocation	188	150	84	110	33
<b>TOTAL</b>	<b>228</b>	<b>150</b>	<b>284</b>	<b>120</b>	<b>33</b>

### Community Partnerships and Joint Ventures

Performance measures can be based on the number and dollar value of partnerships, cost-sharing activities, and investment opportunity buy-ins. Ideally, the net benefit and impact will exceed the sum of the individual contributions. It is challenging to statistically determine net benefits and impact of partnerships and joint ventures. Contributions to community programs are measured through sponsorship recognition and the success of contracts and bids.

### Northern Frontier Visitors Association (NFVA)

NFVA performance measurements are related to components of NFVA's service contract requirements and deliverables. Contract requirements and deliverables are measured through visitor services, such as the fulfillment of visitor information packages, walk-in visitation, and web site visits.

## GENERAL FUND - Economic Development

### Northern Frontier Visitors Centre North Slave Region Visitor Information Packages/Fulfillment 5 Year Comparison

	2007	2008	2009	2010	2011 (YTD)
January	468	391	57	98	268
February	563	286	91	170	220
March	198	149	157	197	428
April	657	252	360	127	120
May	1,929	415	159	299	638
June	1,174	231	826	895	439
July	948	219	227	173	476
August	477	70	636	53	78
September	366	120	189	413	72
October	241	166	59	351	22
November	234	117	27	232	13
December	100	64	108	15	10
<b>TOTAL</b>	<b>7,355</b>	<b>2,480</b>	<b>2,896</b>	<b>3,023</b>	<b>2,784</b>

### Northern Frontier Visitors Centre Website Visits - 5-Year Comparison

	2007	2008	2009	2010	2011
January	21,622	23,261	21,254	24,954	12,567
February	20,154	20,501	18,201	20,940	10,420
March	22,103	24,409	19,499	22,345	11,582
April	20,980	23,329	16,296	19,945	9,626
May	24,037	26,122	20,084	21,102	10,146
June	29,852	23,628	19,040	19,771	10,083
July	28,833	24,202	22,903	18,479	10,983
August	27,588	19,123	22,920	18,464	10,448
September	18,158	18,013	22,656	16,188	8,458
October	17,356	20,118	24,162	16,839	8,251
November	13,365	20,947	23,936	17,091	10,170
December	2,064	19,178	22,436	34,279	9,890
<b>TOTAL</b>	<b>246,112</b>	<b>262,831</b>	<b>253,387</b>	<b>250,397</b>	<b>122,624</b>

### Northern Frontier Visitors Centre North Slave Region Walk-in Visitation by Month - 10-Year Comparison

	2002	2003	2004	2005	2006	2007	2008	2009	2010	2011
January	606	753	706	823	928	854	652	510	942	877
February	945	841	926	1,004	966	1,058	947	894	1,238	1,265
March	1,161	892	948	1,008	1,197	891	1,121	793	1,256	1,736
April	600	559	406	456	500	530	542	475	693	789
May	693	726	555	570	590	694	666	811	932	1,160
June	2,417	2,094	2,252	1,462	1,415	1,688	1,799	1,992	1,689	1,968
July	3,634	3,160	3,445	1,835	2,118	2,305	1,828	2,058	2,457	2,069
August	3,380	2,478	2,143	1,617	2,127	1,838	1,631	1,863	2,112	1,301
September	1,414	1,096	1,303	1,674	1,510	733	1,046	1,354	1,555	2,736
October	434	546	494	419	532	430	524	639	777	1,394
November	379	295	420	410	359	374	344	582	748	1,338
December	802	589	784	952	748	545	635	945	1,017	987
<b>TOTAL</b>	<b>16,465</b>	<b>14,029</b>	<b>14,382</b>	<b>12,230</b>	<b>12,990</b>	<b>11,940</b>	<b>11,735</b>	<b>12,916</b>	<b>15,416</b>	<b>17,620</b>



**Tourism Marketing and Development**

Distribution and fulfillment reports are used to identify market trends and are an important source for determining marketing and product development direction. Tourism visitation is reported by the Government of the Northwest Territories, tour operators, and the Northern Frontier Visitors Centre. Additional measurements are determined through media coverage received.

<b>Northern Frontier Visitors Centre</b>					
<b>Sector Inquiry/Fulfillment Information - 5-Year Comparison</b>					
	2007	2008	2009	2010	2011
Hunting/Fishing	57	31	57	25	10
Road Touring	168	67	70	58	20
Explorers Guide	31	29	19	1	44
Outdoor Adventure	130	20	51	8	8
Student	81	41	81	58	35
Ambassador	0	5	425	0	0
General	1,782	349	482	547	553
Miscellaneous	1,334	484	498	7	1,112
<b>TOTAL</b>	<b>3,583</b>	<b>1,026</b>	<b>1,683</b>	<b>704</b>	<b>1,782</b>

**Minerals, Oil and Gas**

Performance measurements can be determined by the number of new business licenses and employment activity related to the non-renewable resource sectors, and new corporate initiatives and/or real estate activity.

**Research, Planning and Program Development**

Program assessments include: the number of initiatives, study participation, and contributions to sustainable programs; contributions to City and NWT planning initiatives; and enhancements of database and reference materials.

**Diamond Capital of North America™**

Indicators include new diamond/jewellery retailers and business licenses issued to related secondary diamond industries; inquiries associated with diamond activity, purchasing and tourism opportunities; and global media attention received referencing Yellowknife and the diamond industry.

THIS PAGE LEFT BLANK INTENTIONALLY



DEPARTMENT STAFFING

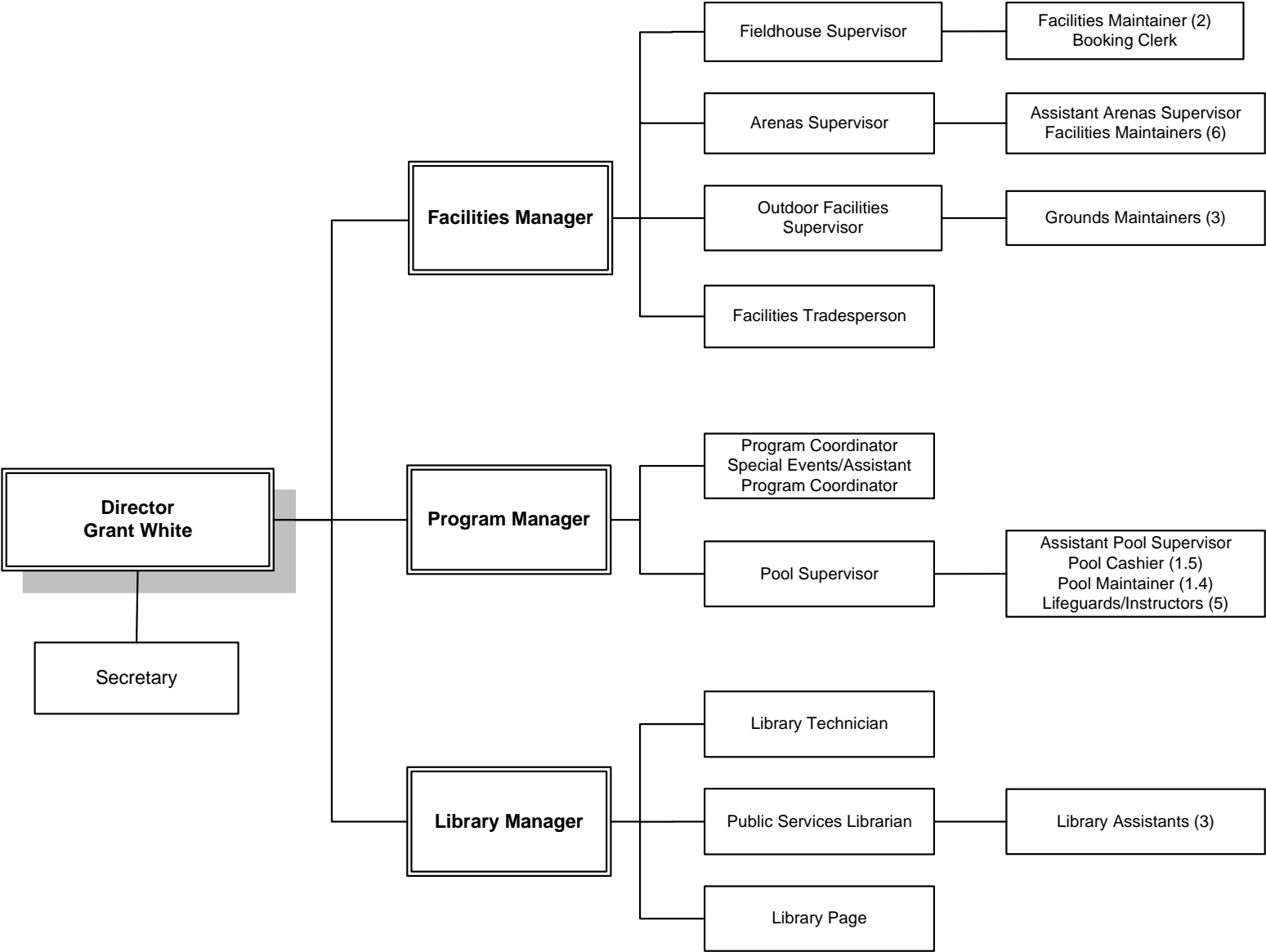



## GENERAL FUND - Community Services

### Staffing Summary

	2001 Actual	2002 Actual	2003 Actual	2004 Actual	2005 Actual	2006 Actual	2007 Actual	2008 Actual	2009 Actual	2010 Actual	2011 Actual	2012 Budget	2013 Budget	2014 Budget	Notes
Directorate	5.00	5.00	5.00	5.00	5.00	5.00	5.00	5.23	5.23	5.23	5.23	6.23	6.23	6.23	
Arenas/Parks	13.20	13.20	14.50	15.00	16.69	17.04	17.26	19.41	20.69	20.70	22.46	20.72	20.72	20.72	
Fieldhouse										3.34	4.00	4.60	4.60	4.60	
Pool	11.70	11.70	11.70	11.70	11.95	11.92	12.10	12.45	12.45	12.66	13.45	13.83	13.83	13.83	
Programs	2.60	2.94	3.94	3.86	3.86	3.86	3.79	4.04	3.87	3.87	3.87	3.62	3.62	3.62	
Library	7.00	7.00	7.00	7.00	6.75	6.75	6.78	6.78	6.78	6.64	6.79	7.18	7.18	7.18	
Curling Club											0.07	0.07	0.07	0.07	(1)
Wildcat Café											0.03	0.03	0.03	0.03	(1)
	<u>39.50</u>	<u>39.84</u>	<u>42.14</u>	<u>42.56</u>	<u>44.25</u>	<u>44.57</u>	<u>44.93</u>	<u>47.91</u>	<u>49.02</u>	<u>52.44</u>	<u>55.90</u>	<u>56.28</u>	<u>56.28</u>	<u>56.28</u>	(2)
Permanent Positions	28.00	28.00	30.00	30.93	32.93	32.93	32.93	36.17	36.17	40.17	39.88	39.88	39.88	39.88	
Part-time/Casual	11.50	11.84	12.14	11.63	11.32	11.64	12.00	11.74	12.85	12.27	16.02	16.40	16.40	16.40	
	<u>39.50</u>	<u>39.84</u>	<u>42.14</u>	<u>42.56</u>	<u>44.25</u>	<u>44.57</u>	<u>44.93</u>	<u>47.91</u>	<u>49.02</u>	<u>52.44</u>	<u>55.90</u>	<u>56.28</u>	<u>56.28</u>	<u>56.28</u>	

Note:

- (1) Forecasted Facilities Tradeperson's time to be spent on these facilities.
- (2) Staff have been reallocated among different facilities in 2011 and 2012.



### COMMUNITY SERVICES DEPARTMENT

The Community Services Department, through its three divisions (Programs, Facilities, and Library), continues to provide quality and diverse recreation and leisure opportunities that reflect the needs of the community. The department also maintains a close working relationship with the many volunteer organizations, groups, individuals, and the private sector who continue to provide programs and events. There are a variety of grant programs and service contracts administered by the department as well. Many capital upgrades and developments to the indoor and outdoor facilities are managed through department resources. The Community Services Department strives to foster a sense of community and community spirit unique to Yellowknife through the delivery of its programs and services.

#### 2011 Highlights

The highlights of the Community Services Department include:

- Ongoing commitment to increasing the proficiency of staff by providing training and development in: Building Operations & Maintenance, Pool Operations, First Aid & Automatic External Defibrillator, Advanced Refrigeration, and Class Program and Facility Booking operations.
- Provision of administrative support and technical advice to a wide range of Council sub-committees including: the Grant Review Committee; Boxing and Wrestling Commission; and the Wildcat Café Advisory Committee.
- Participation in planning and facilitating the Royal Visit. This was a far-reaching and demanding role, considering the magnitude of the occasion and the amount of external media attention the City received.
- Provision of quality programs to the community through a variety of means including the Library, recreational programming, and publicly accessible events.
- The department, in partnership with the Downtown Enhancement Committee, has sustained the attack on litter in the City by increasing the number of litter containers in the downtown area and introduced additional dual litter/recycling containers.
- In a continued effort to ensure facilities are operated and maintained to an acceptable standard and address the infrastructure gap, the

department has:

- Replaced the backup generators at both City Hall and the Community Arena to ensure public and staff safety issues are addressed.
- Continued the preservation of the Wildcat Café as a living heritage building by addressing problems with the structural integrity of the facility.
- Replaced the air handling unit, installed windows with a high efficiency rating, and added air conditioning to the office at the Ruth Inch Memorial Pool.
- Continued replacing aging play equipment in City playgrounds.
- Carried out repairs to the deck infrastructure at the Ruth Inch Memorial Pool.

#### 2012/2013/2014 Goals

The goals of the Community Services Department are to:

- Provide opportunities to enhance recreational, cultural, educational, and informational interests in Yellowknife.
- Provide fair and equitable programs and services which promote participation for people of all ages and abilities, and that are accessible to all.
- Provide safe and comfortable recreation environments for participants and spectators.
- Develop and adapt the City's services to address the ever-changing trends and needs of the community.
- Raise public awareness and involvement in recreation and leisure activities in Yellowknife.
- Expand multi-purpose and multi-use recreation and leisure opportunities within the community.

#### 2012/2013/2014 Objectives

The objectives of the Community Services Department are to:

- Continue to work with committees of Council such as the Wildcat Café Advisory Committee, the Grant Review Committee, and the Boxing and Wrestling Commission to address the specific needs and

## GENERAL FUND - Community Services

interests of the community that are represented through these entities.

- Ensure that the facilities, programs, and services operated by the department are provided in an effective and efficient manner without compromising the safety or comfort of participants and spectators.
- Continue to develop partnerships in the community to further enhance the recreation and leisure opportunities available to the community.

### Department Budget

		2010 Actual (\$000's)	2011 Budget (\$000's)	2011 Forecast (\$000's)	2012 Budget Recommended (\$000's)	2013 Budget (\$000's)	2014 Budget (\$000's)
<b>Revenue</b>							
	Government Transfers						
	Other Grants	115	108	108	108	108	108
	User Charges	1,606	2,058	1,985	2,100	2,141	2,193
		<b>1,721</b>	<b>2,166</b>	<b>2,094</b>	<b>2,208</b>	<b>2,249</b>	<b>2,301</b>
<b>Expenditures (By Activity)</b>							
	Administration	552	596	613	729	748	767
	Arenas	1,875	1,830	1,953	1,837	1,961	2,034
	Fieldhouse	308	626	675	717	735	758
	Yellowknife Curling Club	144	140	132	125	127	130
	Parks	888	968	980	985	1,011	1,038
	Library	994	1,092	1,076	1,144	1,172	1,203
	Pool	1,351	1,379	1,419	1,382	1,444	1,499
	Recreation	460	398	399	393	404	414
	Wildcat	14	11	7	14	15	15
	City Hall	306	326	330	341	348	357
		<b>6,890</b>	<b>7,366</b>	<b>7,585</b>	<b>7,666</b>	<b>7,964</b>	<b>8,215</b>
<b>Net Revenue (Expenditures)</b>		<b>(5,169)</b>	<b>(5,200)</b>	<b>(5,491)</b>	<b>(5,458)</b>	<b>(5,715)</b>	<b>(5,914)</b>
<b>Expenditures (By Object)</b>							
	Wages & Benefits	3,838	4,341	4,470	4,491	4,738	4,905
	Other O&M	3,052	3,025	3,115	3,175	3,225	3,310
		<b>6,890</b>	<b>7,366</b>	<b>7,585</b>	<b>7,666</b>	<b>7,964</b>	<b>8,215</b>



**GENERAL FUND - Community Services**

Directorate Budget		2010	2011	2011	2012	2013	2014	
		Actual	Budget	Forecast	Budget	Budget	Budget	Note
		(\$000's)	(\$000's)	(\$000's)	Recommended	(\$000's)	(\$000's)	
					(\$000's)			
<b>Revenue</b>								
	User Charges	11	41	34	8	8	8	(1)
		11	41	34	8	8	8	
<b>Expenditures (By Activity)</b>								
	Legislation & Governance	152	164	169	188	194	199	
	Facility Operations	79	85	88	145	148	150	
	Program Delivery	114	123	126	139	142	145	
	Library Services	78	84	86	97	99	103	
	Public Information	129	140	144	160	165	170	
		552	596	613	729	748	767	
<b>Net Revenue (Expenditures)</b>		(541)	(555)	(579)	(721)	(741)	(759)	
<b>Expenditures (By Object)</b>								
	Wages & Benefits	487	528	546	613	632	650	
	Other O&M	65	68	68	116	116	117	
		552	596	613	729	748	767	

**Notes:**

(1) User charges are advertising revenues from the Recreation Guide, parks and facilities, and sponsorship opportunities.

### FACILITIES DIVISION – ARENAS

The Facilities Division operates and maintains the Yellowknife Community Arena and the Multiplex for community use. This includes maintaining the equipment and structure of the building and planning future repairs and upgrades to the facilities to ensure the facilities answer the needs of the community. The Facilities Division works closely with several volunteer recreation associations in scheduling the use of the arenas for both summer bookings and winter skating.

#### 2011 Highlights

The highlights of the Facilities Division - Arenas include:

- Provision of high quality customer service to user groups and visitors over the course of the year.
- Continued hosting a wide variety of activities that accentuate the multi-purpose nature of the Yellowknife Community Arena and the Multiplex.
- Continued successful working partnerships with the wide variety of associations that regularly utilize both the Multiplex and Yellowknife Community Arena.
- Continued monitoring the Eco Chill system. This project has reduced the facilities' oil consumption by 40% or 85,000 litres and greenhouse gas (GHG) emission by 250 tonnes or a 5% reduction in the overall City emissions; the system has been expanded to connect to the Fieldhouse.
- Overhaul of one of the compressors at the Multiplex that will avoid unscheduled shutdowns and extend the longevity of the ice plant.
- Installation of a new generator at the Yellowknife Community Arena.

#### 2012/2013/2014 Goals

The goals of the Facilities Division - Arenas are to:

- Generate an increase in revenue in both arenas by creating a more efficient user group schedule.
- Provide safe, comfortable, and enjoyable facilities for residents.
- Achieve the highest quality of service possible within City facilities through responsible management of staff and resources.

- Maintain the Multiplex and Yellowknife Community Arena in such a way as to present a positive image to the public and user groups.
- Ensure that the mechanical aspects of the facilities will realize their full life cycle through a preventative maintenance program that addresses all facets of each facility daily, weekly, and monthly.
- Maintain fast, smooth, and safe ice surfaces at both arenas.
- Assist with the introduction and promotion of the Multiplex for year-round multi-purpose use by the community.
- Install new dehumidifiers at the Multiplex and upgrade the dehumidifiers at the Yellowknife Community Arena.
- Paint the DND Gym and foyer at the Multiplex.
- Replace the damaged façade of the Multiplex.
- Install a new sprinkler system at the Yellowknife Community Arena.
- Install new safety flooring in the lobby of the Yellowknife Community Arena.
- Install a fall protection system for the Multiplex.

#### 2012/2013/2014 Objectives

The objectives of the Facilities Division - Arenas are to:

- Continue with a preventative maintenance program that addresses all facets of each facility daily, weekly, and monthly.
- Work with the various user groups to successfully program and schedule the arenas for the upcoming season.
- Continue to strive for energy efficiency by investigating other available technologies.
- Review alternatives and innovations in facility operations.



**GENERAL FUND - Community Services**

**Arenas Budget**

	2010 Actual (\$000's)	2011 Budget (\$000's)	2011 Forecast (\$000's)	2012 Budget Recommended (\$000's)	2013 Budget (\$000's)	2014 Budget (\$000's)
<b>Revenue</b>						
User Charges	552	750	709	773	796	821
	552	750	709	773	796	821
<b>Expenditures (By Activity)</b>						
Ice Maintenance	262	249	266	231	255	265
Arena Maintenance	944	918	979	922	992	1,031
Plant & Equipment Maintenance	668	663	708	684	714	738
	1,875	1,830	1,953	1,837	1,961	2,034
<b>Net Revenue (Expenditures)</b>	(1,322)	(1,080)	(1,244)	(1,064)	(1,165)	(1,213)
<b>Expenditures (By Object)</b>						
Wages & Benefits	778	904	896	808	915	957
Other O&M	1,097	926	1,058	1,029	1,047	1,078
	1,875	1,830	1,953	1,837	1,961	2,034

**Yellowknife Curling Club Budget**

	2010 Actual (\$000's)	2011 Budget (\$000's)	2011 Forecast (\$000's)	2012 Budget Recommended (\$000's)	2013 Budget (\$000's)	2014 Budget (\$000's)
<b>Revenue</b>						
User Charges	-	-	-	-	-	-
	-	-	-	-	-	-
<b>Expenditures (By Facility)</b>						
YK Curling Club	144	140	132	125	127	130
	144	140	132	125	127	130
<b>Net Revenue (Expenditures)</b>	(144)	(140)	(132)	(125)	(127)	(130)

## GENERAL FUND - Community Services

Arenas Performance Measures	Projected 2010	Actual 2010	Projected 2011	Forecasted 2012	Forecasted 2013	Forecasted 2014	Note
<b>Workload Indicators:</b>							
Yellowknife Community Arena (YKCA)							
Ice rental (hours available for booking)	3,700	3,700	3,700	3,700	3,700	3,700	
Ice rental (non-billable hours)	1,000	1,000	1,000	1,000	1,000	1,000	(1)
Ice rental (billable hours)	2,700	2,700	2,700	2,700	2,700	2,700	
Ice rental (usage in hours)	1,600	1,700	1,800	1,800	1,800	1,800	
Multiplex							
Ice rental (hours available for booking)	12,600	12,600	12,600	12,600	12,600	12,600	
Ice rental (non-billable hours)	3,000	3,000	3,000	3,000	3,000	3,000	(1)
Ice rental (billable hours)	9,400	9,400	9,400	9,400	9,400	9,400	
Ice rental (usage in hours)	7800	7,959	7800	7800	7800	7800	
Gym floor rental (hours available for booking)	6,600	6,600	6,600	6,600	6,600	6,600	
Gym floor rental (non-billable hours)	500	485	500	500	500	500	
Gym floor rental (billable hours)	6,115	6,100	6,100	6,100	6,100	6,100	
Gym floor rental (usage in hours)	4,000	3,596	4,000	4,000	4,000	4,000	
Multi-purpose room rental (hours available for booking)	6,500	6,500	6,500	6,500	6,500	6,500	
Multi-purpose room rental (non-billable hours)	300	300	300	300	300	300	(1)
Multi-purpose room rental (billable hours)	6,200	6,200	6,200	6,200	6,200	6,200	
Multi-purpose room rental (usage in hours)	2,100	2,010	2,100	2,100	2,100	2,100	
<b>Efficiency Measures:</b>							
Yellowknife Community Arena (YKCA)							
Recovery rate	29.90%	40.67%	29.59%	28.71%	25.40%	25.24%	(2)
Usage rate	41%	63%	67%	67%	67%	67%	
Multiplex							
Recovery rate	37.91%	27.42%	38.31%	46.80%	46.65%	46.34%	(2)
Usage rate - Ice	83%	85%	83%	83%	83%	83%	
Usage rate - Gym Floor	66%	59%	66%	66%	66%	66%	
Usage rate - Multi-purpose room	34%	32%	32%	32%	32%	32%	
<b>Effectiveness Measures:</b>							
% of citizens satisfied or very satisfied with the arenas	90%	90%	-	92%	-	94%	(3)

### Notes:

- (1) Facility maintenance hours
- (2) The change from 2010 to 2011 is mainly due to proper reporting of staff allocation.
- (3) This question will be asked every second year in the Citizen Survey.



### FACILITIES DIVISION – PARKS

The Facilities Division operates and maintains Somba K'e Park, Lakeview Cemetery, city parks and trails, the Wildcat Café, Fireweed Studio, and outdoor fields for community use. This involves working closely with several volunteer recreation associations to schedule the use of ball diamonds and soccer pitches. In addition, the division provides services such as delivery of rentable equipment, litter removal in the downtown core, and snow removal in the winter at various city sites. The Facilities Division - Parks also maintains existing equipment and infrastructure within the parks, and plans for the community's future requirements through the budget process.

#### 2011 Highlights

The highlights of the Facilities Division - Parks include:

- Provision of high quality parks, playgrounds, and outdoor rinks for public use.
- Full maintenance control of Somba K'e Park.
- Assumed responsibility for the watering and maintenance of 50<sup>th</sup> Street upgrade.
- Continued beautification of the downtown core, which involved the replacement of dead or vandalized trees with fully mature trees, and the replacement of litter containers.
- Preparation of Somba K'e Park for the Royal Visit.
- Installation of playground equipment at Moyle Park and upgrade to Parker Park.
- Cleaning and brushing of trails.
- Inspection of playgrounds to achieve the Canadian Certified Playground Inspector standard.
- Continued to develop a new block area at the cemetery and prepared 20 plots.
- Worked with the Snowboard Association to develop and maintain a snowboard facility.
- Upgrade to the pathway in front of City Hall.
- Interior renovations at the Fireweed Studio.

#### 2012/2013/2014 Goals

The goals of the Facilities Division - Parks are to:

- Provide safe, comfortable, and enjoyable parks and trails for the residents of Yellowknife.
- Manage staff and resources in a responsible and effective manner.
- Continue to enhance and develop additional green spaces within the city.
- Continue to maintain and upgrade current play areas and structures to a high standard of care and safety.
- Continue effective operational procedures by introducing efficient, cost-saving measures.

#### 2012/2013/2014 Objectives

The objectives of the Facilities Division - Parks are to:

- Maintain the trees located on City property to a high level, ensuring tree replacement does not exceed 10% annually.
- Address 90% of all acts of vandalism within one business day and repair damage within two business days of notification.
- Maintain the five outdoor skating rinks and the skating oval on Frame Lake during the winter months.
- Respond to 90% of maintenance service enquiries and requests within one business day.
- Ensure litter control in the Central Business District is maintained daily at a high standard.
- Investigate and implement new and innovative ways to maintain parks and trails.
- Upgrade and replace playground equipment at Somba K'e Park and Lamoureux Park.
- Install new playground equipment in Moyle Park.
- Complete 20 new graves annually at the cemetery and develop plans for future cemetery expansion.
- Establish a columbarium park at the cemetery.
- Upgrade Fritz Theil field.
- Upgrade soccer and multi-use fields at St. Joseph, Range Lake North and William McDonald schools.



## GENERAL FUND - Community Services

- Continue to work with the Rotary Club to expand the trail at Rotary Park.
- Upgrade ball fields by replacing shale.
- Pave the Niven Lake Trail.

### Parks Budget

	2010 Actual (\$000's)	2011 Budget (\$000's)	2011 Forecast (\$000's)	2012 Budget Recommended (\$000's)	2013 Budget (\$000's)	2014 Budget (\$000's)
<b>Revenue</b>						
User Charges	104	96	92	108	111	115
	104	96	92	108	111	115
<b>Expenditures (By Activity)</b>						
Plant/Equipment Maintenance	80	81	82	81	83	85
Turf Maintenance	248	266	270	268	275	282
Litter Collection	96	108	110	111	114	118
Snow Removal	38	41	41	42	43	44
Parks Maintenance	113	124	125	128	132	135
Sports Fields Maintenance	150	163	165	165	169	174
Special Events	91	106	107	106	109	112
Cemetery Maintenance	49	55	55	59	60	62
Janitorial	23	24	24	24	25	26
	888	968	980	985	1,011	1,038
<b>Net Revenue (Expenditures)</b>	(784)	(873)	(888)	(877)	(899)	(923)
<b>Expenditures (By Object)</b>						
Wages & Benefits	579	715	696	721	741	762
Other O&M	309	253	284	264	270	276
	888	968	980	985	1,011	1,038



**GENERAL FUND - Community Services**

**Parks Performance Measures**

	<b>Projected 2010</b>	<b>Actual 2010</b>	<b>Projected 2011</b>	<b>Forecasted 2012</b>	<b>Forecasted 2013</b>	<b>Forecasted 2014</b>	<b>Notes</b>
<b>Workload Indicators:</b>							
<b>Green Space Maintenance</b>							
Sq. m. of Class A green space maintained	272,642	272,642	309,724	310,705	310,705	310,705	
Sq. m. of Class B green space maintained	48,075	48,075	48,075	48,075	48,075	48,075	
Sq. m. of Class C green space maintained	21,800	21,800	21,800	21,800	21,800	21,800	
No. of transplanted trees maintained in green spaces	500	500	550	800	840	840	
<b>Playground Maintenance</b>							
No. of playgrounds maintained	16	16	17	18	18	18	
<b>Sport Court &amp; Fields Maintenance</b>							
No. of tennis courts maintained	8	8	8	8	8	8	
No. of ball diamonds maintained	7	7	7	7	7	7	
No. of sports pitches maintained	4	4	4	4	4	5	
No. of outdoor ice rinks maintained	6	6	6	6	6	6	
No. of skateboard parks maintained	1	1	1	1	1	1	
No. of basketball courts maintained	5	5	5	5	5	5	
No. of beach volleyball courts maintained	1	1	1	1	1	1	
<b>Trail Maintenance</b>							
Metres of paved trail maintained	2,400	2,400	2,400	2,400	2,400	2,400	
Metres of unpaved trail maintained	5,300	5,300	5,300	5,300	7,500	10,000	(1)
<b>City Core Maintenance</b>							
No. of trees and flower pots maintained in city core	104	104	104	147	147	147	(2)
No. of litter receptacles emptied in city core	125	125	125	130	130	130	(3)
<b>City Hall Grounds Maintenance</b>							
No. of flower beds maintained in City Hall grounds	20	20	20	20	20	20	
No. of days snow is required to be cleared from walkways	120	120	120	120	120	120	(4)
No of days snow is required to be removed from trails	70	70	70	70	70	70	(4)
<b>Cemetery Maintenance</b>							
No. of yearly burials	20	20	20	20	20	20	
No. burial permits issued	84	84	84	80	80	80	
<b>Deliveries</b>							
No. of delivery requests made in a year	145	145	145	145	140	140	
No. of litter containers emptied (excluding city core)	167	167	167	180	180	190	

cont'd...

**GENERAL FUND - Community Services**

**Parks Performance Measures (continued)**

	Projected 2010	Actual 2010	Projected 2011	Forecasted 2012	Forecasted 2013	Forecasted 2014	Notes
<b>Efficiency Measures:</b>							
<b>Green Space Maintenance</b>							
Cost per sq. m. to maintain Class A green space	\$3.05	\$3.05	\$3.05	\$3.25	\$3.50	\$3.50	
Cost per sq. m. to maintain Class B green space	\$1.60	\$1.60	\$1.60	\$1.70	\$2.25	\$2.25	
Cost per sq. m. to maintain Class C green space	\$1.10	\$1.10	\$1.10	\$1.20	\$1.50	\$1.50	
Cost per tree to maintain transplanted trees in green spaces	\$85	\$85	\$85	\$90	\$90	\$90	
<b>Playground Maintenance</b>							
Cost per playground to maintain	\$3,600	3,600	\$3,600	\$3,600	\$3,600	\$3,600	
<b>Sport Court &amp; Fields Maintenance</b>							
Cost per tennis court maintained	\$1,800	\$1,800	\$1,800	\$1,800	\$1,800	\$1,800	
Cost per ball diamond maintained	\$8,100	\$8,100	\$8,100	\$8,100	\$8,100	\$8,100	
Cost per sports pitch maintained	\$13,000	\$13,000	\$13,000	\$13,000	\$13,390	\$13,780	
Cost per outdoor ice rink maintained	\$4,500	\$4,500	\$4,500	\$4,500	\$4,500	\$4,500	
Cost per skateboard park maintained	\$6,500	\$6,500	\$6,500	\$6,500	\$6,670	\$6,870	
Cost per basketball court maintained	\$225	\$225	\$225	\$250	\$250	\$250	
<b>Trail Maintenance</b>							
Cost per m. to maintain trails - summer	\$3.75	\$3.75	\$3.75	\$3.75	\$3.85	\$3.90	
Cost per m. to maintain paved trail - winter	\$3.00	\$3.00	\$3.00	\$3.00	\$3.25	\$3.40	
<b>Down Town Core Maintenance</b>							
Cost per sq. block for litter collection - summer (20 blocks)	\$3,090	\$3,090	\$3,090	\$3,500	\$3,600	\$3,700	
Cost per sq. block for litter collection - winter (20 blocks)	\$1,030	\$1,200	\$1,300	\$1,500	\$1,600	\$1,800	
Cost per trees or flower display maintained in core	\$175	\$175	\$175	\$200	\$210	\$220	
<b>City Hall Grounds Maintenance</b>							
Cost per flower bed maintained in City Hall grounds	\$230	\$230	\$230	\$240	\$245	\$245	
Cost per year to clear walkways of snow	\$12,000	\$12,000	\$12,000	\$12,000	\$12,360	\$12,730	
Cost per year to clear trails of snow	\$12,000	\$12,000	\$12,000	\$12,000	\$12,360	\$12,730	
<b>Cost of Burials</b>	\$7,200	\$7,200	\$7,200	\$7,200	\$7,200	\$7,200	(5)

cont'd...



**GENERAL FUND - Community Services**

---

**Parks Performance Measures (continued)**

	Projected 2010	Actual 2010	Projected 2011	Forecasted 2012	Forecasted 2013	Forecasted 2014	Notes
<b>Effectiveness Measures:</b>							
<b>Trail Maintenance</b>							
% of citizens very satisfied or somewhat satisfied with the condition of the walking trails and bike routes	83%	83%	-	85%	-	87%	(6)
<b>Outdoor Rinks</b>							
% of citizens very satisfied or somewhat satisfied with the maintenance of the City's outdoor rinks	72%	72%	-	74%	-	76%	(6)

**Class A** - Green Space that is kept to the highest standards

**Class B** - Green Space similar to Class A, except the horticulture maintenance program is not as intensive

**Class C** - Green Space with a minimal horticultural maintenance program

**Notes:**

- (1) Anticipated trail expansion on Twin Pine Hill, Tin Can Hill and Old Airport Road
- (2) Addition of trees on 50th and 52nd Avenues
- (3) Addition of dual recycle bins in the city core
- (4) Anticipated days
- (5) Anticipated 20 burials @ \$360 per burial
- (6) Citizen Survey will be conducted every two years

### FACILITIES DIVISION – FIELDHOUSE

The Facilities Division operates and maintains the new Fieldhouse for the community. This includes maintaining the equipment and structure of the building, and planning future repairs and upgrades to meet the needs of the community. The Facilities Division works closely with the Programs Division and several volunteer recreation associations in scheduling the use of the Fieldhouse.

#### 2011 Highlights

These are highlights of the year for the Facilities Division - Fieldhouse:

- Worked with contractors to address problems within the facility.
- Worked with other City departments to develop and implement infrastructure for the facility's operation.
- Worked with the user groups to address their facility and program needs.

#### 2012/2013/2014 Goals

The goals of the Facilities Division - Fieldhouse are to:

- Provide a safe, comfortable, and enjoyable facility for residents.
- Achieve the highest quality of service through responsible management of staff and resources.
- Maintain the Fieldhouse in a way that presents a positive image to the public and user groups.
- Ensure that the mechanical aspects of the facility will realize their full life cycle through a preventative maintenance program.
- Maintain clean, safe track and field surfaces.
- Continue to address the need for equipment and other resources to enhance the facility's operation.
- Assist with the introduction and promotion of the Fieldhouse for year-round multi-purpose use by the community.

#### 2012/2013/2014 Objectives

The objectives of the Facilities Division - Fieldhouse are to:

- Continue to implement a comprehensive, preventative maintenance program that addresses all facets of the facility daily, weekly, and monthly.
- Work with the various user groups to successfully program and schedule the facility for the upcoming season.
- Continue to strive for energy efficiency by investigating available technologies.
- Review alternatives and innovations in the operation of the facility.



## GENERAL FUND - Community Services

Fieldhouse Budget		2010	2011	2011	2012	2013	2014
		Actual (\$000's)	Budget (\$000's)	Forecast (\$000's)	Budget Recommended (\$000's)	Budget (\$000's)	Budget (\$000's)
<b>Revenue</b>							
	User Charges	53	306	293	306	306	306
		53	306	293	306	306	306
<b>Expenditures (By Facility)</b>							
	Fieldhouse	308	626	675	717	735	758
		308	626	675	717	735	758
<b>Net Revenue (Expenditures)</b>		(255)	(320)	(382)	(411)	(429)	(452)

Fieldhouse Performance Measures	Projected 2010	Actual 2010	Projected 2011	Forecasted 2012	Forecasted 2013	Forecasted 2014	Note
<b>Workload Indicators:</b>							
Track - Visits	5,000	5,777	25,000	25,500	26,000	27,500	
Play Area - Visits	2,000	2,350	6,000	6,500	7,000	7,500	
Field One rental (hours available for booking)	2,000	2,000	6,022	6,022	6,022	6,022	(1)
Field One rentals (non-billable hours)	200	200	200	200	200	200	(1)
Field One rentals (billable hours)	1,800	0	0	5,822	5,822	5,822	
Field One rentals (useage in hours)	700	0	0	3,300	3,300	3,300	
Trinity Field rentals (hours available for booking)	2,000	2,000	5,475	5,475	5,475	5,475	
Trinity Field rentals (non-billable hours)	200	200	200	200	200	200	(1)
Trinity Field rentals (billable hours)	1,800	1,800	5,275	5,275	5,275	5,275	
Trinity Field rentals (useage in hours)	1,600	1,705	2,850	3,000	3,000	3,000	
<b>Efficiency Measures:</b>							
Recovery rate	41.5%	17.2%	43.3%	42.8%	41.7%	40.4%	
Field #1 usage rate	39%	45%	57%	57%	57%	57%	
Trinity Field usage rate	89%	95%	54%	57%	57%	57%	(2)
<b>Effectiveness Measures:</b>							
% of citizens satisfied or very satisfied with the Fieldhouse	-	-	-	85%	-	90%	(3)

### Notes:

- (1) Facility maintenance hours
- (2) It was opened in September 2010 and, from September to December 2010, it was heavily used; however, demand declines in the summer months, so the % for the whole year is lower.
- (3) This question will be asked every second year in the Citizen Survey.

### PROGRAMS DIVISION - AQUATICS

The Programs Division manages all recreation programs, including aquatics and special celebrations. Aquatic programs are offered on a seasonal basis according to the demands and needs of the community. The division works closely with the public, volunteer organizations, local school boards, and government agencies to enhance water safety throughout the NWT and, in particular, Yellowknife. The programs offered include Red Cross swim programs, Lifesaving Society and Life Guarding programs, as well as daily swim times for all age groups. This facility also provides rental opportunities to meet the needs of all users or individual groups, from recreation to sport training.

### 2011 Highlights

The highlights of the Programs Division - Aquatics include:

- Continuous training of staff on the use of Automatic External Defibrillator units and fit-testing for self-contained breathing apparatus.
- Another successful Drowning Prevention Week and Water Safety Week (14 swims were sponsored by local businesses or companies).
- Sale of 60 Sponsored Swim times throughout the year.
- Working with day care providers to rent the pool on a regular basis to encourage physical activity for their children.
- Continued to offer a Pool Operator program to give the staff and residents of the NWT the necessary training in the processes of caring for a pool (e.g. water balancing, filter systems).
- Provided Shallow Water Lifeguard training for the communities of Ft. Simpson, Norman Wells and Behchoko.
- Offered successful learn-to-swim programs on Sunday mornings.
- Sandblasted and refurbished the exterior deck.

### 2012/2013/2014 Goals

The goals of the Programs Division - Aquatics are to:

- Evaluate present programming and schedule delivery so that participation increases.
- Develop a strategy to interest local people in becoming instructors and lifeguards for the facility.

- Continue to encourage participation of schools through the Joint Use Agreement.
- Continue to promote drowning prevention in the community.
- Use the Energy Audit Report to reduce energy consumption at the Ruth Inch Memorial Pool.
- Ensure the longevity of the facility by implementing the Mid-Life Cycle evaluation.
- Maximize pool usage through rentals.
- Investigate ways of partnering with day care providers in the delivery of programs that would increase their use of the pool.

### 2012/2013/2014 Objectives

The objectives of the Programs Division - Aquatics are to:

- Develop a budgetary plan to implement the recommendations of the Mid-Life Cycle report for facility upgrade.
- Install a new air handling unit in 2012.
- Replace old lockers in 2013 and 2014.
- Develop a strategy to increase the number of public swim times (Sponsored Swims) so that more children and families can enjoy leisure activities in the pool.
- Continue to partner with the Department of Health, the Jump Start program, and KidSport to encourage people to be more active in Yellowknife.
- Continue to work with the NWT Recreation and Parks Association and the School of Community Government to provide the communities with training programs in pool operation and lifeguarding.
- Continue to partner with local school boards, the Department of National Defence, and local businesses to provide unique safety training. (e.g. plane crash escape training).



GENERAL FUND - Community Services

Aquatics Budget

	2010 Actual (\$000's)	2011 Budget (\$000's)	2011 Forecast (\$000's)	2012 Budget Recommended (\$000's)	2013 Budget (\$000's)	2014 Budget (\$000's)	Note
<b>Revenue</b>							
Government Transfers	-	-	-	-	-	-	
User Charges	521	438	439	449	462	474	
	<u>521</u>	<u>438</u>	<u>439</u>	<u>449</u>	<u>462</u>	<u>474</u>	
<b>Expenditures (By Activity)</b>							
Instruction	277	285	293	294	309	321	
Guarding	383	393	404	414	435	453	
Operations & Maintenance	691	701	721	674	700	725	
	<u>1,351</u>	<u>1,379</u>	<u>1,419</u>	<u>1,382</u>	<u>1,444</u>	<u>1,499</u>	
<b>Net Revenue (Expenditures)</b>	<u>(830)</u>	<u>(941)</u>	<u>(980)</u>	<u>(933)</u>	<u>(982)</u>	<u>(1,025)</u>	
<b>Expenditures (By Object)</b>							
Wages & Benefits	912	934	981	987	1,040	1,083	(1)
Other O&M	439	445	438	395	404	416	
	<u>1,351</u>	<u>1,379</u>	<u>1,419</u>	<u>1,382</u>	<u>1,444</u>	<u>1,499</u>	

Notes:

(1) One additional Lifeguard/Instructor starting from June 1, 2010 onwards.



## GENERAL FUND - Community Services

### Aquatics Performance Measures

	Projected 2010	Actual 2010	Projected 2011	Forecasted 2012	Forecasted 2013	Forecasted 2014	Notes
<b>Workload Indicators</b>							
No. of pool operation hrs.	6,100	5,493	6,000	6,000	6,000	6,000	
% of recreational swim time	32%	32%	32%	32%	32%	32%	
% of aquatic fitness programs	3%	3%	4%	5%	5%	5%	
% of instructional time	25%	25%	25%	25%	25%	25%	
% of rental availability	40%	40%	40%	40%	40%	40%	
No. of rentals	410	426	400	450	450	450	(1)
Number of bookings conducted	5,800	5,438	5,000	5,500	5,500	5,500	(1)
No. of programs offered	330	402	453	400	400	400	
No. of enrollments	1,950	1,738	1,773	2,000	2,000	2,000	
Membership visits	0	16,157	26,587	28,000	28,000	28,000	(2)
Trained pool maintenance coverage (%)	30%	30%	31%	35%	35%	35%	
No. of vandalism reports	15	8	2	5	5	5	(3)
<b>Efficiency Measures</b>							
Pool recovery rate	38.68%	38.58%	30.91%	32.50%	31.97%	31.65%	
% of untrained staff providing maintenance coverage	70%	70%	69%	65%	65%	65%	
No. of unscheduled pool closures	1	1	1	0	0	0	
% of pool rented		90%	92%	100%	100%	100%	(4)
<b>Effectiveness Measures</b>							
% of citizens very satisfied or somewhat satisfied with the operation of the pool	82%	82%	-	85%	-	90%	(5)

#### Notes:

- (1) These indicate the number of rentals the pool handles each year and the bookings are the amendments to each rental.
- (2) Indicates the implementation of the new FlexiPass and the installation of security doors at the pool.
- (3) These indicate the number of vandalized items that are related to broken windows and doors, not graffiti.
- (4) These indicate what percentage of the 38% of pool that is available for rentals is actually booked.
- (5) Citizen Survey conducted every two years. (2006 survey showed 83% of citizens were somewhat or very satisfied.)



### PROGRAMS DIVISION - RECREATION

The Programs Division manages all recreation programs, including aquatics and special celebrations. Programs are offered on a seasonal basis according to demand requests and perceived needs. The division works closely with the public, volunteer organizations, local school boards, and government agencies. The Programs Division also handles facility booking requests and the City funding programs (Special Grants and Core Funding).

#### 2011 Highlights

The highlights of the Programs Division - Recreation include:

- Hosted the New Year's Eve fireworks celebration.
- Continued to offer a wide variety of programs for children and adults.
- Worked with the NWT Recreation & Parks Association and hosted three free Get Active programs this past spring.
- Offered "Play Together", a new drop-in program for parents with preschool children.
- Offered a new "FlexiPass" membership program with overwhelming success in sales.
- Offered 13 special events (Santa Claus Parade, special skates, barbeques, etc.).
- Worked in partnership with the federal and territorial governments to host the Royal Visit of the Duke and Duchess of Cambridge.
- An increase of 48% in online registration for fall programs.
- Worked with community groups in accessing Core Funding and Special Grants.
- Assisted community groups by accepting registrations on behalf of the Yellowknife Minor Hockey Association, Yellowknife Tennis Association, and the NWT Soccer Association (the City was able to generate additional revenue for providing these services).
- Held the Canadian Sledge Hockey National Training Camp in October.
- The gyms and arenas were booked to 90% capacity throughout the winter months (after school and weekends).
- The Multiplex Gym was booked to 95% capacity on weekdays from 7:00 a.m. to 9:30 p.m, and was booked to 60% capacity on weekends.

- The City saw an increase in outdoor field use in 2010 as a result of an increase in outdoor soccer, rugby, and ultimate programs for youths and adults.
- Other sporting interests including football, lacrosse, and field hockey have arisen.
- The Adopt-a-Street program gained ten new families.
- Online registration increased to a high of 48%.

#### 2012/2013/2014 Goals

The goals of the Programs Division - Recreation are to:

- Work with community groups to accept registrations and bookings of non-City facilities.
- Purchase a program that will allow the City to sell gift cards to generate more revenue.
- Work with organizations to host conferences and events in Yellowknife.
- Review the policy and procedures for Special Grants and Core Funding.
- Re-evaluate and develop a new strategy to encourage people to attend noon hour drop-in multi-sport activities at the Multiplex gym and after school programs.
- Increase winter and summer activities (with city-wide and territorial challenges).
- Continue to build partnerships with other City departments in hosting City events (Community BBQ and Santa Claus Parade).
- Continue to work cooperatively with service groups to improve Canada Day celebrations.
- Continue to offer a wide variety of quality programs.
- Continually seek new partnerships and funding opportunities.
- Promote our programs using new trends in technology.
- Continue to promote active living and healthy lifestyle change.
- Continue to promote a city-wide program to reduce litter in our community.
- Develop a working committee that would help the City to receive the Cultural Capital designation for 2014.
- Review fees and charges applied to booking parks for weddings, outdoor concerts, etc.
- Review and revise the City's policy regarding booking facilities for conferences, tradeshow, concerts, weddings, etc.

## GENERAL FUND - Community Services

---

- Continue to meet with the Seniors' Society, sport clubs, Department of National Defence, and day homes to develop partnerships in delivering programs to enhance use of the Fieldhouse.
- Investigate and develop a strategy for contracting instructors or organizations to deliver programs on the City's behalf.
- Investigate the possibilities of online bookings.

### 2012/2013/2014 Objectives

The objectives of the Programs Division - Recreation are to:

- Increase the active living and healthy lifestyle change in the community.
- Increase a city-wide program and campaign to reduce litter in our community.
- Re-evaluate program delivery to increase city-wide events by 5%.
- Promote more of our patrons to do online registrations with a target increase of 5% in each of the next 3 years.
- Continue to promote participation in the Adopt-a-Street program by 5% each year.
- Run diverse programs that cover a wide cross-cultural number of hobbies, interests, and activities for residents of all ages.
- Continue to offer a minimum of 13 special events annually.
- Continue to work with our partner school division to rent the gyms to the public through the Joint Use Agreement.
- Develop strategies with our partners that will reduce garbage on the streets of Yellowknife by the spring of 2012 and beyond.
- Continue to evaluate and improve City special events and programs.
- Develop the City's technology to monitor and control usage of facilities, implement the sale of gift cards, and sell passes online.
- Increase summer usage of the Fieldhouse by 5% each year.
- Increase summer usage of the Multiplex and YK Arena through rentals and programs by 5% over the next three years.



GENERAL FUND - Community Services

---

Recreation Budget

		2010 Actual (\$000's)	2011 Budget (\$000's)	2011 Forecast (\$000's)	2012 Budget Recommended (\$000's)	2013 Budget (\$000's)	2014 Budget (\$000's)
<b>Revenue</b>							
	Government Transfers	10	3	3	3	3	3
	User Charges	310	378	373	389	400	412
		<u>320</u>	<u>381</u>	<u>376</u>	<u>392</u>	<u>403</u>	<u>415</u>
<b>Expenditures (By Activity)</b>							
	Indoor Programs	222	193	193	188	193	197
	Outdoor Programs	141	122	122	122	125	129
	Celebrations	97	83	84	83	85	88
		<u>460</u>	<u>398</u>	<u>399</u>	<u>393</u>	<u>404</u>	<u>414</u>
<b>Net Revenue (Expenditures)</b>		<u>(140)</u>	<u>(17)</u>	<u>(23)</u>	<u>(1)</u>	<u>(1)</u>	<u>0</u>
<b>Expenditures (By Object)</b>							
	Wages & Benefits	300	269	269	262	272	281
	Other O&M	160	129	130	131	132	133
		<u>460</u>	<u>398</u>	<u>399</u>	<u>393</u>	<u>404</u>	<u>414</u>

## GENERAL FUND - Community Services

Recreation Division Performance Measures	Projected 2010	Actual 2010	Projected 2011	Forecasted 2012	Forecasted 2013	Forecasted 2014	Notes
<b>Workload Indicators</b>							
No. of special events	14	14	14	13	13	13	
No. of Adopt-a-Street partners	70	70	76	80	84	88	(1)
No. of recreational/playground programs	180	223	296	225	225	225	
No. of rental contracts	1,800	1,672	1,636	1,675	1,675	1,675	(2)
No. of bookings completed	17,000	21,340	19,719	21,000	21,000	21,000	(2)
No. of gym hours available :							
Public schools	26,712	26,444	27,373	29,000	29,000	29,000	
Catholic schools	13,823	13,823	17,146	14,000	14,000	14,000	
Francophone schools	0	2	0	0	0	0	
No. of gross registrations in programs	10,000	6,125	7,000	10,000	10,000	10,000	
No. of net registrations in programs	8,000	3,885	4,500	8,000	8,000	8,000	
No. of gross registrations for non-City programs	741	834	849	1,000	1,000	1,000	
No. of net registrations in non-City programs	658	646	769	1,000	1,000	1,000	(3)
Online registrations	30%	33%	48%	50%	55%	60%	
<b>Efficiency Measures</b>							
% of costs recovered by the Programs - Recreation	99.8%	69.6%	94.2%	99.8%	99.8%	100.0%	
% of gym space available rented	80%	80%	85%	85%	85%	85%	
% of city streets covered under the Adopt-a-Street program	27%	27%	28%	29%	30%	30%	
<b>Effectiveness Measures</b>							
% of citizens very satisfied or somewhat satisfied with the recreational programs and services offered	-	-	-	85%	-	88%	(4)

### Notes:

- (1) The increase in participants reflects an increase in the area cleaned through the Adopt-a-Street Program.
- (2) Rental contracts created in a year and bookings include amendments and alterations to contracts.
- (3) It reflects workload through registration in person, by phone and/or via internet.
- (4) Citizen Survey will be conducted every two years. The 2006 survey showed 83% of citizens were satisfied. This question was not asked in 2008 and 2010.



### LIBRARY DIVISION

The Library Division is part of the Community Services Department and provides library services to the population of Yellowknife, as well as acting as a resource for other libraries in the NWT. This division is responsible for the operation of Yellowknife Public Library and, in this role, supports the educational and recreational reading, viewing, and listening needs of its patrons. It does this by developing and making available a strong collection, and by offering a variety of programs designed to enhance the appreciation of literature in its many forms. The Library Manager heads this division and reports to the Director of Community Services.

### 2011 Highlights

The highlights of the Library Division include:

- Numerous special interest programs: Summer Reading Encouragement Program, Preschool Story Time, narrated slideshows and Classic Cinema evenings, as well as varied adult and family literacy initiatives including English as a Second Language (ESL) and computer literacy programs.
- Author presentations by William Deverell, Jan Andrews, Janet Wilson, and Eugenie Fernandes.
- Successful Food for Fines initiative in partnership with the Yellowknife Food Bank.
- Continued development of a strong working relationship with the Friends of Yellowknife Public Library.
- Two successful used book sales in conjunction with the Friends of Yellowknife Public Library.
- Continued expansion of the DVD and Books on CD collections.
- Use of Facebook to spread information about the library and its programs.
- Creation of a Book Club Collection.
- Continued creation of themed children's collections.
- Initiating a collection of works by Canadian illustrators of children's books.
- Inventory.
- Completed planning for library signage.

### 2012/2013/2014 Goals

The goals of the Library Division are to:

- Provide services and materials in all formats to meet the informational, educational, technological, cultural, and recreational needs of the residents of Yellowknife.
- Create a library environment that is safe, aesthetically pleasing, and conducive to patron use.
- Assess and accommodate the needs of the diverse population of Yellowknife and provide adequate resources to meet perceived needs.
- Develop and promote working relationships with other libraries to share resources.

### 2012/2013/2014 Objectives

The objectives of the Library Division are to:

- Continue to balance acquisitions and deletions in order to accommodate space limitations and to ensure a current and useful collection.
- Develop the French collection.
- Continue to improve the adult literacy and ESL collections.
- Continued promotion of the Self-Check machine.
- Extension of services beyond the physical library.
- Establish a partnership with the Canadian National Institute for the Blind (CNIB Library).
- Develop an e-book resource.
- Determine community readiness for Blu-ray technology in order to plan for the transition from the current DVD collection.
- Provide an online tool for learning a second language.
- Work with the IT Department to enhance functionality and increase vibrancy of the library website.
- Renovate the back room to better support staff comfort and technical service.
- Develop relevant programming and outreach initiatives for present and potential future users who constitute a rapidly changing demographic such as teens, new immigrants, seniors and disadvantaged individuals with low literacy skills.

GENERAL FUND - Community Services

Library Budget

	2010 Actual (\$000's)	2011 Budget (\$000's)	2011 Forecast (\$000's)	2012 Budget Recommended (\$000's)	2013 Budget (\$000's)	2014 Budget (\$000's)
<b>Revenue</b>						
Government Transfers	105	105	105	105	105	105
User Charges	25	26	24	38	29	29
	130	131	129	143	134	134
<b>Expenditures (By Activity)</b>						
Circulation	292	325	320	344	355	365
Cataloguing	156	166	163	171	175	180
Collection Development	68	71	70	74	75	77
Programs	59	64	63	71	68	70
Reference	176	193	190	204	210	216
Building	103	100	98	102	104	106
Internet	28	30	30	56	58	60
Inter-Library Loan	113	144	142	122	126	130
	994	1,092	1,076	1,144	1,172	1,203
<b>Net Revenue (Expenditures)</b>	(864)	(961)	(948)	(1,001)	(1,038)	(1,070)
<b>Expenditures (By Object)</b>						
Wages & Benefits	608	640	624	673	697	717
Other O&M	386	452	452	471	475	486
	994	1,092	1,076	1,144	1,172	1,203



## GENERAL FUND - Community Services

Library Performance Measures	Projected 2010	Actual 2010	Projected 2011	Forecasted 2012	Forecasted 2013	Forecasted 2014	Notes
<b>Workload Indicators</b>							
Items Circulated:							
Videos	32,000	44,539	40,000	40,000	40,000	40,000	
Other	60,000	67,325	70,000	70,000	70,000	75,000	
Items added to collection	5,500	5,978	5,000	5,500	6,000	6,000	
Size of collection	50,000	57,000	60,000	65,000	65,000	65,000	(1)
Hours open to the public	2,944	2,944	2,944	2,944	2,944	2,944	
Programs offered	90	96	80	100	100	100	(2)
Meeting room rentals (no. of times space is used)	500	440	450	450	450	450	
Inter-library loans:							
No. of requests by the City Library	900	1,031	1,000	1,000	1,000	1,000	
No. of requests by other libraries	700	715	700	700	700	700	
No. of items sent to other libraries	700	620	600	600	600	600	
Reference questions	14,000	15,056	15,000	15,000	15,000	15,000	
Total number of patron visits	200,000	191,353	200,000	200,000	200,000	200,000	
Public behavioural challenge incidents	200	187	200	200	200	200	
Average time spent by staff per incident in minutes	20	20	20	20	20	20	
Library members served per FTE staff member	908	925	972	938	950	950	(3)
<b>Efficiency Measures</b>							
Average material cost per item	\$13.45	\$12.37	\$14.80	\$13.72	\$12.83	\$13.10	
Library services net cost per capita	\$45.73	\$43.36	\$42.83	\$49.06	\$50.29	\$51.26	
Net cost per hour of operation	\$311.48	\$293.48	\$293.48	\$340.17	\$352.58	\$363.38	
Percent of total budget spent on facility maintenance	10.34%	10.36%	9.11%	8.92%	8.87%	8.81%	
Percentage of time public computers are in use	100%	95%	95%	95%	95%	95%	
<b>Effectiveness Measures:</b>							
% of citizens very satisfied or somewhat satisfied with the Library	82%	82%	-	83%	-	85%	(4)
Circulation per capita	4.59	5.61	5.45	5.39	5.33	5.51	
Visits per capita	9.97	9.60	9.91	9.80	9.69	9.58	
Reference questions per capita	0.70	0.76	0.74	0.73	0.73	0.72	
Collection development cost per capita	\$3.54	\$3.71	\$3.67	\$3.70	\$3.69	\$3.77	
Percent of total budget spent on materials	7.09%	8.44%	6.88%	6.60%	6.57%	6.53%	
Average number of attendees per program	30	25	25	25	25	25	
Inter-library loan requests per capita	0.05	0.05	0.05	0.05	0.05	0.05	
Library membership as percentage of total population	20.8%	35%	38%	38.0%	38.0%	37.0%	
Annual turnover of circulating materials	1.84	1.96	1.83	1.69	1.69	1.77	

### Notes:

- (1) Space restrictions, continued weeding and an inventory conducted in early 2011 are expected to result in reduced collection size.
- (2) Programming reduced to support increased circulation activity.
- (3) Membership definition: members who have used their cards once over a three-year period.
- (4) Citizen Satisfaction Survey to be conducted every two years.



### FACILITIES DIVISION – CITY HALL

The Facilities Division operates and maintains the City Hall building in a way that will ensure that the mechanical, structural, and electrical elements of the facility will realize their full life cycle. This is done through the implementation of a preventative maintenance program that addresses the requirements of the facility daily, weekly, and monthly and also through capital upgrades planned for the future needs of the facility.

#### 2011 Highlights

The highlights of the Facilities - City Hall Division include:

- Provided a high quality of customer service by City staff over the course of the year.
- Provided new carpet and flooring in the office space of the Municipal Enforcement Division.
- Secured contracts for janitorial work within the facility as well as mechanical work on the ventilation system and the elevator.
- Completed new ventilation system for City Hall.
- Completed the installation of a new free air system for the IT server room.
- Worked with the IT Division to secure a better ventilation system for their facility.
- Installed a new generator for the facility.

#### 2012/2013/2014 Goals

The goals of the Facilities - City Hall Division are to:

- Provide a safe, comfortable, and enjoyable work environment for employees.
- Achieve the highest quality of service possible within the facilities, through responsible management of staff and resources.
- Ensure that the mechanical systems of the building will realize their full life cycle by continuing with the preventative maintenance program.
- Install a new boiler and replace the roof over the next few years. This will address the major equipment and structural issues for the facility.

#### 2012/2013/2014 Objectives

The objective of the Facilities - City Hall Division is to:

- Address the preventative maintenance program and issues to ensure the needs of the facility are met on a daily, weekly, and monthly basis.



**GENERAL FUND - Community Services**

---

**City Hall Budget**

	2010 Actual (\$000's)	2011 Budget (\$000's)	2011 Forecast (\$000's)	2012 Budget Recommended (\$000's)	2013 Budget (\$000's)	2014 Budget (\$000's)
<b>Revenue</b>						
User Charges	23	23	23	23	23	23
	23	23	23	23	23	23
<b>Expenditures (By Facility)</b>						
City Hall	306	326	330	341	348	357
	306	326	330	341	348	357
<b>Net Revenue (Expenditures)</b>	(283)	(303)	(308)	(319)	(325)	(335)

**City Hall Performance Measures**

	Projected 2010	Actual 2010	Projected 2011	Forecasted 2012	Forecasted 2013	Forecasted 2014
<b>Workload Indicators:</b>						
City Hall maintenance						
No. maintenance requests received	330	300	340	340	340	340
No. City staff person-hours used on maintenance	190	200	200	200	200	200
No. contractor person-hours used on maintenance	250	240	260	260	260	260
<b>Efficiency Measures:</b>						
Average time spent tending to one request (in minutes)	25	25	25	25	25	25

### FACILITIES DIVISION – WILDCAT CAFÉ

The Facilities Division maintains the Wildcat Café throughout the year. This includes maintaining the equipment and structure of the building and planning future repairs to the facility. This is all done keeping in mind that the facility is a living heritage site and must be preserved in its original state as long as possible. The Facilities Division also manages the contract for the operation of the Wildcat Café as a restaurant, including using the Request for Proposal process to secure interested operators.

#### 2011 Highlights

The highlights of the Facilities Division - Wildcat Café include:

- In conjunction with the contractor and the Wildcat Café Advisory Committee, the facility was totally dismantled and the foundation repaired. The building is currently being re-assembled for operation in 2012.

#### 2012/2013/2014 Goals

The goals of the Facilities Division - Wildcat Café are to:

- Carry out the necessary repairs to ensure the building continues to operate as a living heritage site.
- Secure a contractor to operate the restaurant for the 2012 and 2013 season.
- Provide a safe and enjoyable facility for both the residents of Yellowknife and visitors to the City.
- Achieve the highest quality of service possible within the facility through responsible management of the Wildcat Café contractor.
- Ensure that the mechanical systems of the facility realize their full life cycle by continuing the preventative maintenance program.

### 2012/2013/2014 Objectives

The objectives of the Facilities Division - Wildcat Café are to:

- Continue to deliver a satisfying and enjoyable experience to those who visit and eat at the establishment.
- Implement a preventative maintenance program that addresses all facets of operation of the Wildcat Café.



**GENERAL FUND - Community Services**

---

**Wildcat Café Budget**

	2010 Actual (\$000's)	2011 Budget (\$000's)	2011 Forecast (\$000's)	2012 Budget Recommended (\$000's)	2013 Budget (\$000's)	2014 Budget (\$000's)	Note
<b>Revenue</b>							
User Charges	7	-	-	7	7	7	(1)
	<u>7</u>	<u>-</u>	<u>-</u>	<u>7</u>	<u>7</u>	<u>7</u>	
<b>Expenditures (By Facility)</b>							
Wildcat	14	11	7	14	15	15	(1)
	<u>14</u>	<u>11</u>	<u>7</u>	<u>14</u>	<u>15</u>	<u>15</u>	
<b>Net Revenue (Expenditures)</b>	<u>(7)</u>	<u>(11)</u>	<u>(7)</u>	<u>(7)</u>	<u>(8)</u>	<u>(8)</u>	

**Notes:**

(1) Wildcat is closed in 2011 for renovation and repair.

**Wildcat Café Performance Measures**

	Projected 2010	Actual 2010	Projected 2011	Forecasted 2012	Forecasted 2013	Forecasted 2014	Notes
<b>Workload Indicators</b>							
Maintenance calls received	10	4	5	10	10	10	(1)
Community Services staff hours	130	110	40	80	80	80	(1)
Contractor hours	160	150	0	160	160	160	(1)

**Note**

(1) The Wildcat Café is closed in 2011 for renovation.

THIS PAGE LEFT BLANK INTENTIONALLY



**GENERAL FUND - Public Safety**

**DEPARTMENT STAFFING**

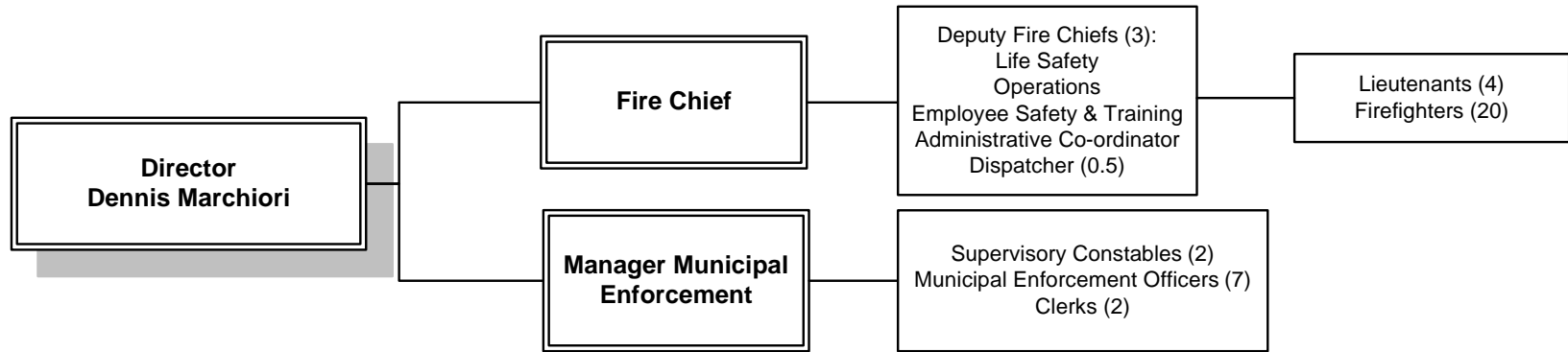

**Staffing Summary**

	2001 Actual	2002 Actual	2003 Actual	2004 Actual	2005 Actual	2006 Actual	2007 Actual	2008 Actual	2009 Actual	2010 Actual	2011 Actual	2012 Budget	2013 Budget	2014 Budget	Note
Directorate	0.00	0.00	0.00	0.00	0.00	1.00	1.00	1.00	1.00	1.00	1.00	1.00	1.00	1.00	
Fire and Ambulance	20.00	20.00	24.00	24.00	24.00	24.00	25.00	27.08	29.08	29.58	29.58	29.58	29.58	29.58	(1) & (2)
Municipal Enforcement	9.80	9.30	9.30	10.30	10.49	10.34	10.33	10.34	12.00	12.00	12.00	12.00	12.00	12.00	(3)
	<b>29.80</b>	<b>29.30</b>	<b>33.30</b>	<b>34.30</b>	<b>34.49</b>	<b>35.34</b>	<b>36.33</b>	<b>38.42</b>	<b>42.08</b>	<b>42.58</b>	<b>42.58</b>	<b>42.58</b>	<b>42.58</b>	<b>42.58</b>	
Permanent Positions	29.50	29.00	33.00	34.00	34.00	35.00	36.00	38.08	42.08	42.58	42.58	42.58	42.58	42.58	
Part-time/Casual	0.30	0.30	0.30	0.30	0.49	0.34	0.33	0.34	0.00	0.00	0.00	0.00	0.00	0.00	
	<b>29.80</b>	<b>29.30</b>	<b>33.30</b>	<b>34.30</b>	<b>34.49</b>	<b>35.34</b>	<b>36.33</b>	<b>38.42</b>	<b>42.08</b>	<b>42.58</b>	<b>42.58</b>	<b>42.58</b>	<b>42.58</b>	<b>42.58</b>	

Note:

- (1) Two firefighters each year were added in July of 2008 and 2009. One full-time dispatcher from April 2010 onwards and the cost is to be shared equally with Water & Sewer Division.
- (2) Facility Tradesperson in 2008 onwards = .08 PY
- (3) In 2009, one additional Municipal Enforcement Officer 1 and Supervisory Constable were added.

### PUBLIC SAFETY DIRECTORATE

The Public Safety Department is responsible for four service areas: emergency services (fire, ambulance, rescue and hazardous materials), enforcement (municipal enforcement), homelessness coalition activities, and emergency preparedness. The managers who head each of these divisions report to the director, who sets the course and objectives for the department.

#### 2011 Highlights

The highlights of the Department of Public Safety include:

- Worked with the GNWT and other first responders towards understanding the roles and responsibilities of various first responders when looking at any incident outside our City boundaries;
- Along with Corporate Services, continued work towards the upgrade of the City's overall communications infrastructure to allow for efficient and effective overall operations as they relate to radio utilization for both emergency and non-emergency situations;
- Along with other partners in the city (GNWT Health and Social Services, Yellowknife Health and Social Services Authority and BHP Billiton Canada), continued the review of the three-year pilot project for a day shelter within the City;
- Continued work with the Yellowknife Homelessness Coalition on a proposed new transition home for women and women with children.

#### 2012/2013/2014 Goals

The goals of the Department of Public Safety are to:

- Provide a safe environment for residents and visitors to Yellowknife, and support other communities when they are experiencing an emergency;
- Provide emergency responses to medical, fire, dangerous goods and other situations in an efficient and competent manner;
- Be a lead department when responding to declared states of local emergency, and to further define the role of the City and its employees during specific types of emergencies;
- Provide a consistent, fair and timely response to the public in the

- enforcement of the City's by-laws and territorial statutes;
- Provide the assistance required for the Yellowknife Homelessness Coalition as required by the federal government funding program, and support projects approved by the Coalition.

#### 2012/2013/2014 Objectives

The objectives of the Department of Public Safety are to:

- Continue to provide comprehensive administration of City by-laws, territorial statutes and regulations governing the safe operation of motor vehicles, bicycles, snowmobiles and other equipment;
- Continue to provide emergency aid, fire protection, dangerous goods and other situational responses to the residents of Yellowknife;
- Ensure that the City is in a state of readiness in the event that an emergency takes place in Yellowknife, through public education or through preparation activities by the City. Further, to continue to work with other agencies to ensure a timely and effective response – including any training activities;
- Continue to assist the Yellowknife Homelessness Coalition and its partners as they complete projects for those that have found themselves to be homeless while within the City;
- Work towards the implementation of a 9-1-1 emergency phone system in Yellowknife.



**GENERAL FUND - Public Safety**

**Department Budget**

	2010 Actual (\$000's)	2011 Budget (\$000's)	2011 Forecast (\$000's)	2012 Budget Recommended (\$000's)	2013 Budget (\$000's)	2014 Budget (\$000's)
<b>Revenue</b>						
Government Transfers	-	-	-	-	-	-
User Charges	2,059	2,062	2,184	2,180	2,185	2,185
	2,059	2,062	2,184	2,180	2,185	2,185
<b>Expenditures (By Activity)</b>						
Administration	177	184	184	183	186	193
Fire & Ambulance	3,404	3,713	3,655	3,845	3,983	4,283
Municipal Enforcement	1,292	1,378	1,451	1,476	1,518	1,560
	4,873	5,275	5,289	5,504	5,687	6,035
<b>Net Revenue (Expenditures)</b>	(2,814)	(3,214)	(3,105)	(3,325)	(3,502)	(3,851)
<b>Expenditures (By Object)</b>						
Wages & Benefits	4,174	4,690	4,574	4,752	4,928	5,265
Other O&M	699	585	715	752	758	771
	4,873	5,275	5,289	5,504	5,686	6,036
<b>Interfund Transfers</b>						
To Downtown Development Reserve	108	105	120	120	121	121
	4,982	5,380	5,409	5,624	5,807	6,157

**Directorate Budget**

	2010 Actual (\$000's)	2011 Budget (\$000's)	2011 Forecast (\$000's)	2012 Budget Recommended (\$000's)	2013 Budget (\$000's)	2014 Budget (\$000's)
<b>Revenue</b>						
Government Transfers	-	-	-	-	-	-
	-	-	-	-	-	-
<b>Expenditures (By Activity)</b>						
Legislation & Governance	44	46	46	47	48	49
Public Information	35	37	37	40	41	42
Policy Development	53	55	55	46	47	48
Long-Range Planning	44	46	46	50	51	53
	177	184	184	183	186	193
<b>Net Revenue (Expenditures)</b>	(177)	(184)	(184)	(183)	(186)	(193)
<b>Expenditures (By Object)</b>						
Wages & Benefits	164	174	174	171	176	181
Other O&M	13	10	10	12	10	12
	177	184	184	183	186	193



### MUNICIPAL ENFORCEMENT DIVISION

The Municipal Enforcement Division is responsible for the enforcement of numerous City by-laws as well as the *Northwest Territories Motor Vehicles Act* and the *All-Terrain Vehicles Act*. Officers conduct patrols by foot, bike, vehicle and snowmobile. The division also maintains approximately 575 on-street parking meters. The division is comprised of:

- A manager who oversees the division, budget and policies;
- Two supervisory constables who supervise the constables' day-to-day activities, conduct court prosecution twice a week and deal with public complaints;
- Six constables who respond to public complaints and proactively enforce City by-laws, the *Northwest Territories Motor Vehicles Act* and the *All-Terrain Vehicles Act*;
- One constable whose main duty is to enforce parking in the Central Business District. This officer also enforces other by-laws in the district;
- Two clerks who do all ticket and other data entry, answer phone, dispatch complaints to officers, deal with the public at the counter.

### 2011 Highlights

The highlights of the Municipal Enforcement Division include:

- The 27th Annual Bicycle Rodeo was another great success with hundreds of children attending. Many fantastic prizes were donated and given out to participants.
- Constables delivered bicycle safety talks to approximately 1,800 school children.
- In July a new patrol car was put into service. Patrol cars were also equipped with mobile computers which allow officers to perform much of their work on the streets, rather than having to return to the office. These mobile computers also allow officers to do motor vehicle checks from their patrol vehicles.
- Patrol cars were equipped with a new in-car camera system, replacing a system that was five years old.
- Parking meter mechanisms were replaced in May.

### 2012/2013/2014 Goals

The goals of the Municipal Enforcement Division are to:

- Enforce City by-Laws and mandated territorial statutes in a fair, competent and consistent manner, thereby enhancing public safety and meeting the City's legal requirements;
- Provide timely response to requests by citizens, City Administration and departments for service related to infractions and enforcement of by-laws and other statutes;
- Provide other legislative, administrative and investigative support to the City, the courts and outside agencies as may be required;
- Provide a safe environment for the City's residents and visitors and act as a support division in the event of an emergency.

### 2012/2013/2014 Objectives

The objectives of the Municipal Enforcement Division are to:

- Provide full coverage to the citizens of Yellowknife from 7:00 a.m. to midnight daily with on-call/standby coverage from 12:00 a.m. to 7:00 a.m. utilizing a maximum of three officers, two supervisors, and four patrol vehicles;
- Monitor and enforce speed limits within the City, with special emphasis on the eight school zones, by being present in at least one school zone during each of the three daily high traffic periods;
- Perform a once-daily patrol of the city for loose dogs and garbage infractions;
- Increase and maintain the minimum 90% rate of recovery for offences;
- Conduct snowmobile patrols during the snowmobile season, weather and other conditions permitting;
- Ensure sidewalks in the control area are being maintained by the adjacent property owners;
- Ensure that traffic on Franklin Avenue in the Central Business District is monitored during the morning and evening rush hour periods;
- Continue patrols of high-profile parking meters;
- Continue to provide support and assistance to other protective service agencies when requested.



**GENERAL FUND - Public Safety**

---

**Municipal Enforcement Division Budget**

	2010 Actual (\$000's)	2011 Budget (\$000's)	2011 Forecast (\$000's)	2012 Budget Recommended (\$000's)	2013 Budget (\$000's)	2014 Budget (\$000's)	Notes
<b>Revenue</b>							
Grants	-	-	-	-	-	-	
User Charges	1,164	1,172	1,272	1,292	1,297	1,297	(1)
	<u>1,164</u>	<u>1,172</u>	<u>1,272</u>	<u>1,292</u>	<u>1,297</u>	<u>1,297</u>	
<b>Expenditures (By Activity)</b>							
Parking Enforcement	220	229	241	240	246	253	
Traffic Enforcement	456	489	514	535	550	565	
Dog Control	247	265	279	290	298	306	
Licences & Permits	183	196	206	206	212	219	
Court Duties	118	127	134	130	135	139	
Public Information	68	73	76	75	77	79	
	<u>1,292</u>	<u>1,378</u>	<u>1,451</u>	<u>1,476</u>	<u>1,518</u>	<u>1,560</u>	
<b>Net Revenue (Expenditures)</b>	<u>(129)</u>	<u>(206)</u>	<u>(179)</u>	<u>(184)</u>	<u>(221)</u>	<u>(263)</u>	
<b>Expenditures (By Object)</b>							
Wages & Benefits	1,125	1,213	1,217	1,243	1,283	1,322	
Other O&M	167	165	234	233	235	238	
	<u>1,292</u>	<u>1,378</u>	<u>1,451</u>	<u>1,476</u>	<u>1,518</u>	<u>1,560</u>	

**Notes:**

(1) Starting from April 1, 2011 parking ticket fines have increased by 25%.

## GENERAL FUND - Public Safety

Municipal Enforcement Performance Measures	Projected 2010	Actual 2010	Projected 2011	Forecasted 2012	Forecasted 2013	Forecasted 2014	Notes
<b>Workload Indicators</b>							
Notices of Infractions issued:							
No. of parking infractions	12,000	10,947	12,000	12,000	12,000	12,000	
No. of traffic infractions	2,200	2,025	2,200	2,200	2,200	2,200	
No. of dog infractions	150	115	150	150	150	150	
No. of misc. infractions	100	76	100	100	100	100	
No. of summons issued	2,000	2,357	2,400	2,400	2,400	2,400	
Licences issued:							
No. of dog licences	1,450	1,353	1,400	1,400	1,400	1,400	
No. of snowmobile licences	1,700	1,286	1,500	1,500	1,500	1,500	
No. of taxi/chauffeur permits	295	276	295	295	295	295	
<b>Efficiency Measures</b>							
Division cost per capita	\$68.13	\$64.84	\$71.93	\$72.31	\$73.55	\$74.74	
Parking enforcement cost per ticket issued	\$3.80	\$4.47	\$4.34	\$4.40	\$4.52	\$4.63	
<b>Effectiveness Measures</b>							
% of citizens very satisfied or somewhat satisfied with traffic enforcement	75%	75%	-	77%	-	78%	(1) & (3)
Recovery rate of fines issued	90%	90%	90%	90%	90%	90%	
% of citizens feel that traffic enforcement is very or somewhat important as compared to other services	81%	81%	-	85%	-	86%	(2) & (3)

**Note:**

- (1) 2006 Citizen Survey showed 71% of citizens were satisfied; 2008 survey showed 72% satisfaction.
- (2) It was 85% in 2006 survey and 84% in 2008.
- (3) This question will be asked every second year of survey.



### FIRE AND AMBULANCE DIVISION – EMERGENCY SERVICES

The Fire and Ambulance Division – Emergency Services is responsible for four areas mandated by Council. These are fire protection, emergency medical, hazardous materials, and rescue. The Fire Chief reports to the Director of Public Safety who oversees the division and provides a level of advice and support.

#### 2011 Highlights

The highlights of the Fire and Ambulance Division – Emergency Services include:

- The approval and commencement of the Fire Hall expansion. This expansion will improve the current living space and efficiency of the apparatus bay. Expected completion date is early 2012.
- Replacement of three Self-Contained Breathing Apparatus (SCBA) and 50 personal SCBA masks. This is the second part of a three-year replacement program. The new SCBA meets the new NFPA standards with added safety features for firefighters.
- Continued completion of the radio infrastructure upgrade. This phase supplied the Fire Division with new mobile radios, base stations, desk sets, and Emergency Operation Centre (EOC) equipment, all of which is better suited to emergency operations.
- Procurement of a replacement for Engine 6 was initiated and awarded to Rocky Mountain Phoenix. Delivery of the new pumper/tanker will take place in spring 2012.
- New decontamination equipment was purchased for hazardous material incidents. This new equipment will accommodate up-to-date (best practices) decontamination procedures which will improve the health and safety of the firefighters.
- A new burn structure was purchased and is currently being used for firefighter training. This new burn structure allows for our National Fire Protection Association (NFPA) 1001, Level 2 training to be conducted here in Yellowknife. This new training initiative will mean significant savings to our training budget by reducing the amount of Paid-on-Call (POC) firefighters who would previously have been sent south for this type of training.
- A New Recruit training program was initiated for Paid-on-Call firefighters. Six candidates participated in the program.

- Continued officer training for the Fire Chief, Deputy Fire Chiefs, Lieutenants and Senior Firefighters. These are Management Courses that are part of the NFPA 1021 Fire Officer Certification Program.
- Continued cost-effective training program for POC firefighters through the Justice Institute of British Columbia (JIBC). This new training program allows new firefighters to reach National Fire Protection Association (NFPA) standards at a pace geared to each individual's comfort level.
- Two staff members received training to the level of Hazardous Material Technician, enhancing the ability and increasing the knowledge level of all responders within the division.
- Initiated the use of Quick Access Plans (QAP) for establishments that present a high risk to the life and safety of occupants, and continued to develop more QAPs. These plans are a very simple but effective form of pre-planning for emergencies which will improve our command and control.

#### 2012/2013/2014 Goals

The goals of the Fire and Ambulance Division – Emergency Services are to:

- Continue to respond to situations that threaten the health, safety and well-being of the citizens of the City in a timely manner;
- Provide services including fire suppression, pre-hospital care, specialized rescue, dangerous goods/hazardous materials response and mitigation, and numerous non-emergency responses;
- Develop succession plans for both career and paid-on-call members and review possible alternatives to staffing vacancies within the division;
- Reduce the number of false alarms being responded to by the Fire Division allowing for fewer call-outs, less overtime, and better use of responders' time with training, equipment familiarization, or responses to other calls;
- Work with other City departments to maintain an effective dispatch service, until the Fire and Ambulance Division gets its own stand-alone dispatch.

### 2012/2013/2014 Objectives

The objectives of the Fire and Ambulance Division – Emergency Services are to:

- Provide 24/7 coverage by senior management for command and control assistance of major incidents;
- Continue monitoring and improving service levels;
- Continue to develop strategies and operational plans for fires in non-hydrant areas and confined space areas of the city;
- Continue creating Quick Access Plans for establishments that present a high risk to the life and safety of occupants for more efficient command and control of emergencies.
- Fully utilize Fire and Ambulance Division resources in a manner that effectively suppresses, controls or eliminates threats to lives, property, and the environment by providing appropriate benchmarks for response times;
- Continue to evaluate and implement technical advances being made in emergency fire and medical services by securing property, apparatus, and equipment as deemed necessary and appropriate, both fiscally and with the aim of providing optimum service to our clients;
- Continue to maintain a high level of training and development for all staff.



### FIRE AND AMBULANCE DIVISION – LIFE SAFETY AND PREVENTION

The Fire and Ambulance Division – Life Safety and Prevention is responsible for the organization and delivery of identified Life Safety Programs that deal with local safety threats to citizens, improving emergency response capability, and delivery of educational activities that promote a safe community through presentations and use of local media. This division also works closely with local authorities such as the City's Building Inspections Division, GNWT Office of the Fire Marshal, GNWT Electrical and Gas Protection Branch, Department of Health Early Childhood Development, as well as building owners and citizens on public safety inspection complaints and conducts fire inspections where practical and applicable.

#### 2011 Highlights

The highlights of the Fire and Ambulance Division – Life Safety and Prevention include:

##### *Inspections:*

- Responded to inspection requests and life safety complaints with regard to residential, commercial and business properties within the City of Yellowknife.
- Completed inspections of apartment buildings inspections with the assistance of the Duty Crews.
- Completed the annual dayhome and daycare inspections, working in conjunction with GNWT Early Childhood Development programs.
- Completed annual inspections of schools, the hospital and seniors' centres.

##### *Prevention:*

- Fire safety presentations for students from pre-school to Grade 2 as well as summer camp students. These presentations include fire safety DVDs, discussion on fire safety issues, practical fire safety drills, and fire hall tours. The firefighter mini-challenge was added during the summer months.
- Followed up with the schools regarding the use of the Risk Watch Program (program for students from K – 8, dealing with smart choices in 8 different high risk categories). Coalition partners include RCMP, Municipal Enforcement, GNWT Dept. of Transportation, and Public Health.

- Providing the Juvenile Firesetters Program for families of children who were caught playing with lighters/matches.
- Continuing with the “Remembering When” program (fall and fire safety for seniors)

##### *Fire Prevention Week:*

- Fire safety presentations to approx. 1,600 students with an invitation to participate in draws. They were asked to prepare fire escape plans and practice them (approx. 300 entries)
- Open House – Included fire extinguisher training, vehicle extrication demo, sprinkler demo with live burns, various displays, and refreshments. Donations of time and supplies from Kimberlite Career & Technical Centre, J & A Fire Protection, Igloo Building Supplies, Corothers Home Building Centre, Northern Wall & Ceiling, Public Works, and Fire Prevention Services, as well as Northern Property REIT. This was the most successful open house in the past 20 years at YKFD.
- Educated public through Public Service Announcements (PSA) in Capital Update, Coffee Break News, YK Trader Break Time, and NorthwesTel Cable. These businesses donated space for the weekly PSAs.

#### 2012/2013/2014 Goals

The goals of the Fire and Ambulance Division – Life Safety and Prevention are to:

- Continue to conduct dayhome, daycare and school inspections as well as respond to life safety complaints;
- Inspections on commercial buildings (time permitting);
- Continue with current programs: Juvenile Fire Setters, Risk Watch, Remembering When, Fire Prevention Week, Fire Safety presentations to any group or organization submitting a request;
- Continue to form community partnerships with the aim of developing and embracing marketing strategies to better promote, fund, and deliver Life Safety and Prevention programs.

### 2012/2013/2014 Objectives

The objectives of the Fire and Ambulance Division - Life Safety and Prevention are to:

- Increase public awareness of the scope and purpose of all Life Safety and Prevention programs and prioritize program target areas based on demographic analysis;
- Increase the level of inspection activities in public and commercial structures and actively promote prevention and life safety through increased public awareness.



GENERAL FUND - Public Safety

Fire and Ambulance Division Budget

	2010 Actual (\$000's)	2011 Budget (\$000's)	2011 Forecast (\$000's)	2012 Budget Recommended (\$000's)	2013 Budget (\$000's)	2014 Budget (\$000's)
<b>Revenue</b>						
User Charges	896	890	912	888	888	888
	896	890	912	888	888	888
<b>Expenditures (By Activity)</b>						
<u><b>Emergency Operations:</b></u>						
Command & Control	886	953	938	1,012	1,050	1,146
Emergency Response	950	1,145	1,127	1,061	1,103	1,193
Training	576	622	612	688	711	766
Preventative Maintenance	707	696	685	756	778	824
<u><b>Life Safety &amp; Prevention:</b></u>						
Command & Control	128	131	129	119	123	128
Inspection Services	65	102	100	108	113	117
Training	56	59	58	61	63	65
Prevention/Life Safety	35	4	4	41	43	44
	3,404	3,713	3,655	3,845	3,983	4,283
<b>Net Revenue (Expenditures)</b>	(2,509)	(2,823)	(2,743)	(2,957)	(3,095)	(3,395)
<b>Expenditures (By Object)</b>						
Wages & Benefits	2,884	3,304	3,183	3,338	3,469	3,762
Other O&M	520	409	471	507	513	521
	3,404	3,713	3,655	3,845	3,983	4,283



## GENERAL FUND - Public Safety

### Fire and Ambulance Division - Emergency Services Performance Measures

	Projected 2010	Actual 2010	Projected 2011	Forecasted 2012	Forecasted 2013	Forecasted 2014	Notes
<b>Workload Indicators:</b>							
No. of fire suppression responses	180	166	170	160	160	150	(1)
No. of pre-hospital responses	2,700	2,629	2,800	2,800	2,800	2,800	(2)
No. of rescue responses	40	33	40	40	40	40	
No. of hazmat responses	35	40	35	35	35	35	
No. of false alarm responses	N/A	228	200	180	170	160	(3)
No. of preventative maintenance hours	5,210	5,000	5,000	5,000	5,000	5,000	
No. of employee development and training hours	20,000	15,000	15,000	15,000	15,000	15,000	(4)
<b>Efficiency Measures:</b>							
Net cost per capita	\$117.15	\$111.60	\$121.53	\$128.79	\$133.39	\$145.66	
<b>Effectiveness Measures:</b>							
% of time for on-shift staff managing medical emergency responses without overtime callout	98%	98%	98%	98%	98%	98%	
% of time for on-shift staff managing emergency fire responses without overtime callout	80%	86%	86%	86%	86%	86%	
% of time for on-shift staff managing emergency rescue/dangerous goods responses without overtime callout	90%	86%	86%	86%	86%	86%	
% of citizens very satisfied or somewhat satisfied with fire service	96%	96%	-	92%	-	96%	(5)
Avg. target intervention time to 90% of the general public (minutes)	5.06	5.06	5.06	5.06	5.06	5.06	
Comparison of overtime callouts of off-duty career staff needed to respond to emergencies	70	63	70	70	70	70	

**Note:**

- (1) Fire responses should decrease based on increased prevention strategies.
- (2) Pre-hospital responses are likely to increase as population increases.
- (3) This is a new workload indicator and the reduction in false alarm responses is directly related to the billing for false alarms.
- (4) Training hours are hard to determine based on staff turnover and retention of POC firefighters.
- (5) YKFD expects a decrease in satisfaction based on the recent exposure to the fees for fire responses.



## GENERAL FUND - Public Safety

---

### Fire and Ambulance Division - Life Safety and Prevention Performance Measures

	Projected 2010	Actual 2010	Projected 2011	Forecasted 2012	Forecasted 2013	Forecasted 2014	Notes
<b>Workload Indicators:</b>							
No. of fire inspections/complaints	150	210	200	200	200	200	
No. of carbon monoxide checks	70	45	40	40	40	40	(1)
No. of people given tours and lectures	1,000	2,400	2,400	2,400	2,500	2,500	(2)
No. of media/public relations activities	50	64	60	60	60	60	
No. of senior citizen activities	7	6	6	6	6	6	
No. of lockboxes/evacuations	150	50	50	50	50	50	(3)
<b>Efficiency Measures:</b>							
Cost per capita for life safety and prevention	\$14.36	\$14.29	\$14.44	\$16.10	\$16.55	\$16.97	

**Note:**

- (1) Very difficult to determine how many requests from the general public the Fire & Ambulance Division will receive each year for this workload indicator.
- (2) Large school presentations during Fire Prevention Week increased this workload indicator.
- (3) Public safety/water/ice/odours of smoke have been removed from this workload indicator.

THIS PAGE LEFT BLANK INTENTIONALLY



**GENERAL FUND - Planning & Development**

**DEPARTMENT STAFFING**

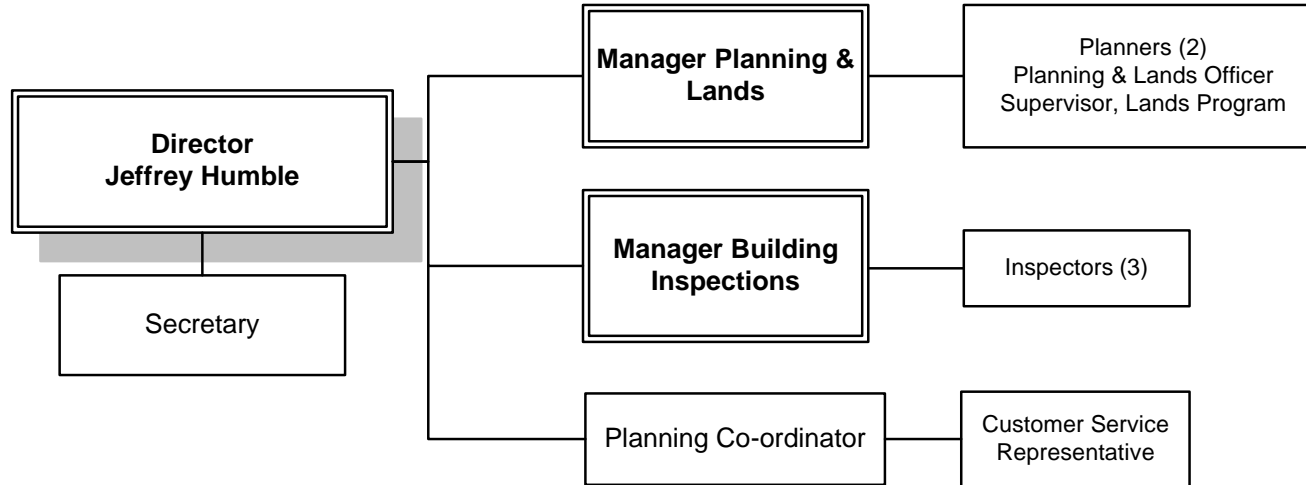

**Staffing Summary**

	2001 Actual	2002 Actual	2003 Actual	2004 Actual	2005 Actual	2006 Actual	2007 Actual	2008 Actual	2009 Actual	2010 Actual	2011 Actual	2012 Budget	2013 Budget	2014 Budget	Notes
Directorate	2.00	2.00	2.00	2.00	2.00	2.00	2.00	2.00	2.00	2.00	3.00	4.00	4.00	4.00	(1)
Building Inspections	4.50	5.00	5.00	5.00	5.00	5.00	5.00	5.00	5.00	5.00	5.00	4.00	4.00	4.00	(2)
Planning & Lands	5.00	5.50	6.00	6.00	6.00	6.00	6.00	6.23	6.00	6.00	5.00	5.00	5.00	5.00	(1)
	<b>11.50</b>	<b>12.50</b>	<b>13.00</b>	<b>13.00</b>	<b>13.00</b>	<b>13.00</b>	<b>13.00</b>	<b>13.23</b>	<b>13.00</b>	<b>13.00</b>	<b>13.00</b>	<b>13.00</b>	<b>13.00</b>	<b>13.00</b>	
Permanent Positions	11.50	12.50	13.00	13.00	13.00	13.00	13.00	13.00	13.00	13.00	13.00	13.00	13.00	13.00	
Part-time/ Casual	0.00	0.00	0.00	0.00	0.00	0.00	0.00	0.23	0.00	0.00	0.00	0.00	0.00	0.00	
	<b>11.50</b>	<b>12.50</b>	<b>13.00</b>	<b>13.00</b>	<b>13.00</b>	<b>13.00</b>	<b>13.00</b>	<b>13.23</b>	<b>13.00</b>	<b>13.00</b>	<b>13.00</b>	<b>13.00</b>	<b>13.00</b>	<b>13.00</b>	

**Notes:**

- (1) In 2011, Planning & Lands Coordinator position has been reclassified as Planning Coordinator and is moved from Planning & Lands to Directorate.
- (2) Starting in 2012, Customer Service Representative will be reallocated from Building Inspections to Directorate.

### PLANNING AND DEVELOPMENT

#### Overview

The Planning and Development Department oversees land administration, issuance of development and building permits, application of the Zoning By-law and long-range strategic growth, and the development and design of the city. The department consists of two divisions which report to the director: the Planning and Lands Division and the Building Inspections Division.

#### 2011 Highlights

The highlights of the Planning and Development Department include:

- Establishment of the Smart Growth Implementation Committee and commencement of the implementation strategy;
- Adoption of the Terms of Reference for the Yellowknife Harbour Plan Committee and appointment of committee members;
- Hosting of several Yellowknife Harbour Plan consultation stages and presentation to Council for adoption of the Harbour Plan Background Report and Harbour Strategic Plan;
- Completion of Old Airport Road Phase 1 and 2 streetscaping construction and commencement of Phase 3 design;
- Completion of 52<sup>nd</sup> Street partnerships and streetscape design/construction partnership with Dundee REIT;
- Completion of Niven Lake VII landscaping of Moyle Park and Phase VII Niven Gate;
- Presentation of an eco-housing feasibility analysis and final report to Council for adoption, and funding applications to CanNor and P3 Canada;
- Continued promotion of energy efficiency through EnerGuide for New Homes 80 (EGNH-80) program and pursuit of Leadership in Energy and Environmental Designs designation for the Fieldhouse;
- Submission of \$2 million in grant requests to CanNor for Smart Growth and Harbour Plan initiatives;
- Completion of marketing plan for final stage of Niven Lake Phase VII;
- Completion of lot layout of Enterprise Drive extension in Kam Lake;

- Hosting of public consultation sessions and presentation of the Background Report and General Plan for adoption by Council;
- Working with Yellowknives Dene First Nation (YKDFN) on municipal boundary issue and Akaitcho Land Withdrawal.

#### 2012/2013/2014 Goals

The goals of the Planning and Development Department are to:

- Digitize storage of existing permits to free storage space and integrate with the City's document management system;
- Streamline permit review through automation software to improve efficiency and customer service;
- Continue to provide educational material to the public to increase transparency and responsiveness to planning and development issues;
- Complete a review of the current Zoning By-law based on the adoption of the new General Plan;
- Continue to increase public awareness and appreciation of the role of Planning and Development in the community via participatory planning (workshops, seminars and design charrettes) and promotional material (e.g. brochures, standards and guidelines, and published documents);
- Foster partnerships with the private sector, territorial and federal government departments, and First Nations to resolve land issues and promote the development objectives of the City.

#### 2012/2013/2014 Objectives

- Encourage development and redevelopment of the City through creative strategies and policies related to land assembly, development incentives, public private partnerships, and general administration of the Land Development Fund;
- Continue to build capacity in implementing the EGNH-80 to ensure a smooth transition to the mandatory requirements which are currently in place;
- Implement the recommendations of the Smart Growth Development Plan, General Plan, and Harbour Plan;
- Pursue the construction of the Eco-Housing project;



- Continue with streetscaping initiatives in downtown area and on Old Airport Road;
- Complete municipal boundary amendments with the YKDFN and GNWT Department of Municipal and Community Affairs;
- Complete land sales in Niven Lake Phase VII;
- Commence the planning and land assembly strategy for residential growth which balances greenfield development and intensification to provide an array of housing choices for residents;
- Complete development schemes for Tin Can Hill/Con Mine areas and Kam Lake.

## GENERAL FUND - Planning & Development

Department Budget		2010	2011	2011	2012	2013	2014	Note
		Actual (\$000's)	Budget (\$000's)	Forecast (\$000's)	Budget Recommended (\$000's)	Budget (\$000's)	Budget (\$000's)	
<b>Revenue</b>								
	Government Transfers	-	-	-	-	-	-	
	Other Grants	-	-	-	-	-	-	
	User Charges	716	853	776	792	862	912	(1)
		<u>716</u>	<u>853</u>	<u>776</u>	<u>792</u>	<u>862</u>	<u>912</u>	
<b>Expenditures (By Activity)</b>								
	Administration	262	274	306	436	450	466	
	Building Inspections	482	526	522	466	480	496	
	Planning & Lands	695	845	755	745	810	830	
		<u>1,438</u>	<u>1,645</u>	<u>1,582</u>	<u>1,646</u>	<u>1,741</u>	<u>1,792</u>	
<b>Net Revenue (Expenditures)</b>		<u>(723)</u>	<u>(792)</u>	<u>(807)</u>	<u>(854)</u>	<u>(879)</u>	<u>(880)</u>	
<b>Expenditures (By Object)</b>								
	Wages & Benefits	1,301	1,416	1,348	1,423	1,518	1,567	
	Other O&M	137	229	234	223	223	225	
		<u>1,438</u>	<u>1,645</u>	<u>1,582</u>	<u>1,647</u>	<u>1,741</u>	<u>1,792</u>	
<b>Interfund Transfers</b>								
	From Downtown Development Reserve	(7)	(78)	(78)	(78)	(78)	(78)	
		<u>1,431</u>	<u>1,567</u>	<u>1,504</u>	<u>1,569</u>	<u>1,663</u>	<u>1,714</u>	

**Note:**

(1) Since January 2011 the commercial business license fee has increased from \$150 to \$200.

### Directorate Budget

Directorate Budget		2010	2011	2011	2012	2013	2014
		Actual (\$000's)	Budget (\$000's)	Forecast (\$000's)	Budget Recommended (\$000's)	Budget (\$000's)	Budget (\$000's)
<b>Expenditures (By Activity)</b>							
	Legislation & Governance	50	52	58	85	88	91
	Public Information	57	59	66	91	94	97
	Policy Development	78	81	91	130	134	139
	Long-Range Planning	78	82	91	130	134	139
		<u>262</u>	<u>274</u>	<u>306</u>	<u>436</u>	<u>450</u>	<u>466</u>
<b>Expenditures (By Object)</b>							
	Wages & Benefits	244	254	287	423	438	454
	Other O&M	18	20	20	13	12	12
		<u>262</u>	<u>274</u>	<u>306</u>	<u>436</u>	<u>450</u>	<u>466</u>



### PLANNING AND LANDS DIVISION

In accordance with the direction provided by Council, the Planning and Lands Division coordinates and facilitates the planning, development and disposition of lands within Yellowknife. The division is responsible for a broad range of professional, administrative and technical services.

These responsibilities include the preparation and realization of long-range land use plans (such as the General Plan and Development Schemes), and the provision of information and policy recommendations on land-related subjects (such as land purchases and sales, land development, urban design guidelines, senior government legislation and mapping). In addition, a major portion of the staff's time is devoted to administration of the Zoning By-law which is used to manage development and land use change in accordance with City Council's long-range land use plans. Staff also manage all of the City's land-related transactions, including purchases, sales, leases, agreements and the by-laws required for each through the Land Administration By-law.

### 2011 Highlights

The highlights of the Planning and Lands Division include:

- Adoption of the new Land Administration By-law;
- Revision of all Planning and Lands policies;
- Creation of agreement templates for all sales, leases and other agreements;
- Improvements to Land Sale website, updated daily;
- Establishment of Smart Growth Implementation Committee and commencement of implementation strategy;
- Adoption of Terms of Reference for the Yellowknife Harbour Plan Committee and appointment of committee members;
- Hosting several Yellowknife Harbour Plan consultation stages and presenting to Council for adoption the Harbour Plan Background Report and Harbour Strategic Plan;
- Completion of Old Airport Road Phase 1 and 2 streetscaping construction and commenced Phase 3 design;
- Completion of 52nd Street partnership and streetscape design/construction partnership with Dundee REIT;
- Completion of Niven Lake VII, landscaping of Moyle Park and Phase

VII Niven Gate;

- Presentation of eco-housing feasibility analysis and final report to Council for adoption and completion of funding applications to CanNor and P3 Canada;
- Continued promotion of energy efficiency through EnerGuide to New Homes 80 program, and pursuit of Leadership in Energy and Environmental Designs designation for the Fieldhouse;
- Submission of \$2 million in grant requests to CanNor for Smart Growth and Harbour Plan initiatives;
- Completion of marketing plan for the final stage of Niven Lake Phase VII;
- Completion of lot layout for Enterprise Drive extension in Kam Lake;
- Hosting public consultation sessions and presentation of the Background Report and General Plan for adoption by Council;
- Continuation of work with Yellowknives Dene First Nation on municipal boundary issue and Akaitcho Land Withdrawal.

### 2012/2013/2014 Goals

In addition to the departmental goals, the goals of the Planning and Lands Division are to:

- Continue a new Community Engagement process with neighbourhoods in Yellowknife;
- Adoption of the 2011 General Plan;
- Overhaul of the City's Zoning By-law to reflect the new General Plan ;
- Annual revisions to the Land Administration By-law;

### 2012/2013/2014 Objectives

- Encourage development and redevelopment of the City through creative strategies and policies related to land assembly, development incentives, public private partnerships, and general administration of Land Development Fund;
- Continue to build capacity on implementing the EGNH-80 to ensure a smooth transition to the mandatory requirements which are currently in place;
- Implement the recommendations of the Smart Growth Development Plan, General Plan and Harbour Plan;
- Pursue the construction of the Eco-Housing project;



## GENERAL FUND - Planning & Development

- Continue with streetscaping initiatives in downtown area and on Old Airport Road;
- Complete municipal boundary amendments with the YKDFN and GNWT Department of Municipal and Community Affairs;
- Complete sales in Niven Lake Phase VII; begin planning and continue with land assembly strategy that balances residential growth (greenfield versus intensification) to provide an array of housing choices for residents;
- Complete development schemes for Tin Can Hill/Con Mine area and Kam Lake.

### Planning and Lands Budget

	2010 Actual (\$000's)	2011 Budget (\$000's)	2011 Forecast (\$000's)	2012 Budget Recommended (\$000's)	2013 Budget (\$000's)	2014 Budget (\$000's)
<b>Revenue</b>						
Grant	-	-	-	-	-	-
User Charges	62	60	63	70	70	70
	62	60	63	70	70	70
<b>Expenditures (By Activity)</b>						
Council	27	33	29	28	31	32
Land Use Planning	184	231	206	206	223	229
Land Administration	220	256	229	218	243	249
Development Approval Process	150	185	166	157	175	180
Heritage Committee	39	48	43	46	47	48
Smart Growth Implementation	75	91	81	89	90	91
	695	845	755	745	810	830
<b>Net Revenue (Expenditures)</b>	(632)	(785)	(692)	(675)	(740)	(760)
<b>Expenditures (By Object)</b>						
Wages & Benefits	589	656	562	555	619	637
Other O&M	105	189	193	190	191	193
	695	845	755	745	810	830



## GENERAL FUND - Planning & Development

---

### Planning & Lands Performance Measures

	Projected 2010	Actual 2010	Projected 2011	Forecasted 2012	Forecasted 2013	Forecasted 2014	Notes
<b>Workload Indicators:</b>							
Development Permits issued	400	421	400	400	400	400	
Land Applications	25	28	20	20	20	20	
Subdivision Applications	13	15	13	13	13	13	
Memos to Committee	80	81	80	80	80	80	
Development Permit Appeals	1	1	1	1	1	1	
Development Schemes	2	0	0	3	0	0	
Major Public Forums/Consultation	10		10	20	20	20	
Residential land sold (full lots, not portions)	14	13	4	26	2	2	
Total value (residential)	\$3,316,000	\$2,255,000	\$1,662,561	\$2,600,000	\$200,000	\$200,000	(1)
Total value (commerical, industrial)	\$0	\$707,000	\$0	\$1,700,000	\$1,700,000	\$1,700,000	(2)
Heritage Committee meetings	11	11	11	11	11	11	
Downtown Enhancement Committee meetings	11	11	0	0	0	0	(3)
Smart Growth Plan Committee meetings	5	5	0	0	0	0	(3)
Smart Growth Implementation Committee meetings	2	2	9	10	10	10	(3)
Harbour Planning Committee meetings	5	5	7	0	0	0	

#### Notes:

- (1) In 2011, includes 16 lots in Niven Lake Phase 7 - single family lots and multi-family parcels.
- (2) Multiple sales have been made - Engle Business District, Kam Lake and other parcels - however, sales will not close in 2011.
- (3) Smart Growth Plan Committee and Downtown Enhancement Committee have been replaced by the Smart Growth Implementation Committee.

### BUILDING INSPECTIONS DIVISION

#### Overview

To better serve the public, the Building Inspections Division restructured in 2011 to provide only inspection services to the residents of Yellowknife. The division reviews applications for building and mechanical permits and provides inspection services to holders of permits. The division's overall objective is to ensure that renovations, additions or newly constructed buildings are fit for occupancy by applying the standards set out in the National Building Code of Canada and the City of Yellowknife Building By-law.

In June 2011, issuing of business licences and administering the Business By-law was transferred to the Directorate, Planning and Development.

#### 2011 Highlights

The highlights of the Building Inspections Division include:

- Implementation of minimum energy efficient building standards for all new commercial, industrial and institutional building construction. The minimum standard is 25% better than the minimum required by the Model National Energy Code for Buildings (MNECB 1997);
- Implementation of a computer-based mobile inspections system that links the permitting process to the City's network, providing faster service to the client, reducing paperwork and streamlining the management and on-site inspection services;
- Ongoing training of Building Inspectors to develop skills in energy modeling, mechanical and ventilation systems and building depressurization practice.

#### 2012/2013/2014 Goals

In addition to overall departmental goals, the specific goals of the Building Inspections Division are to:

- Continue to facilitate the minimum energy efficient building standards with owners and builders;
- Provide information packages in several formats to facilitate the building and mechanical permit application process;
- Review plans and issue a building permit by the effective date of the development permit, provided that the permit application is complete with all requisite submissions;
- Schedule site inspections within one working day of receiving the request for an inspection;
- Store and retain construction documents and permitting matters in electronic format.

#### 2012/2013/2014 Objectives

The objectives of the Building Inspections Division are to:

- Place information packages on the City's website on matters pertaining to permits, applications, submission requirements, energy efficiency standards;
- Develop cross-functionality between the Inspectors to facilitate services to clients and the general public;
- Manage all permits issued from approval to completion by taking a proactive approach with the client.
- Streamline the permit approval and inspection processes to minimize the number of times applicants and permit holders must personally visit City Hall to meet with Inspectors.



## GENERAL FUND - Planning & Development

### Building Inspections Budget

	2010 Actual (\$000's)	2011 Budget (\$000's)	2011 Forecast (\$000's)	2012 Budget Recommended (\$000's)	2013 Budget (\$000's)	2014 Budget (\$000's)	Note
<b>Revenue</b>							
User Charges	654	793	713	722	792	842	
	654	793	713	722	792	842	(1)
<b>Expenditures (By Activity)</b>							
Permit Issuance	170	184	183	163	168	174	
Inspections	150	161	160	143	147	152	
Permit Follow-ups	69	77	77	68	71	73	
Complaints & Investigations	46	52	51	46	47	49	
Public Inquiries	46	52	51	46	47	49	
	482	526	522	466	480	496	
<b>Net Revenue (Expenditures)</b>	172	267	191	256	312	346	
<b>Expenditures (By Object)</b>							
Wages & Benefits	468	505	499	445	460	476	
Other O&M	14	21	22	21	20	20	
	482	526	522	466	480	496	

**Notes:**

(1) Since January 2011 the commercial business license fee has increased from \$150 to \$200.

### Building Inspections Division Performance Measures

	Projected 2010	Actual 2010	Projected 2011	Forecasted 2012	Forecasted 2013	Forecasted 2014	Note
<b>Workload Indicators:</b>							
<b>Permits Issued</b>							
Residential	516	544	500	500	500	500	
Commercial	143	146	175	175	175	175	
Other	50	36	100	100	100	100	
Total Permits	709	726	775	775	775	775	
<b>Number of visits by inspector</b>	1105	1246	1200	1200	1200	1200	
<b>Number of energy audits completed</b>	22	36	40	40	40	40	
<b>Construction Values (\$000,000s)</b>							
Residential	18	24	20	20	20	20	
Commercial	35	39	40	40	40	40	
Total Value	53	63	60	60	60	60	
<b>Business Licences</b>							
No. of Business Licences Issued	1,587	1,588	1,600	1,600	1,600	1,600	
<b>Effectiveness Measures</b>							
Avg. No. of days to issue a permit	14	14	14	14	14	14	(1)

**Note:**

(1) Inspections Division issues a permit on the effective date of the development permit (i.e. 14 days after the development permit's approval date), providing the applicant has submitted all of the documents required to complete a plan review.

THIS PAGE LEFT BLANK INTENTIONALLY



**GENERAL FUND - Public Works & Engineering**

**DEPARTMENT STAFFING**

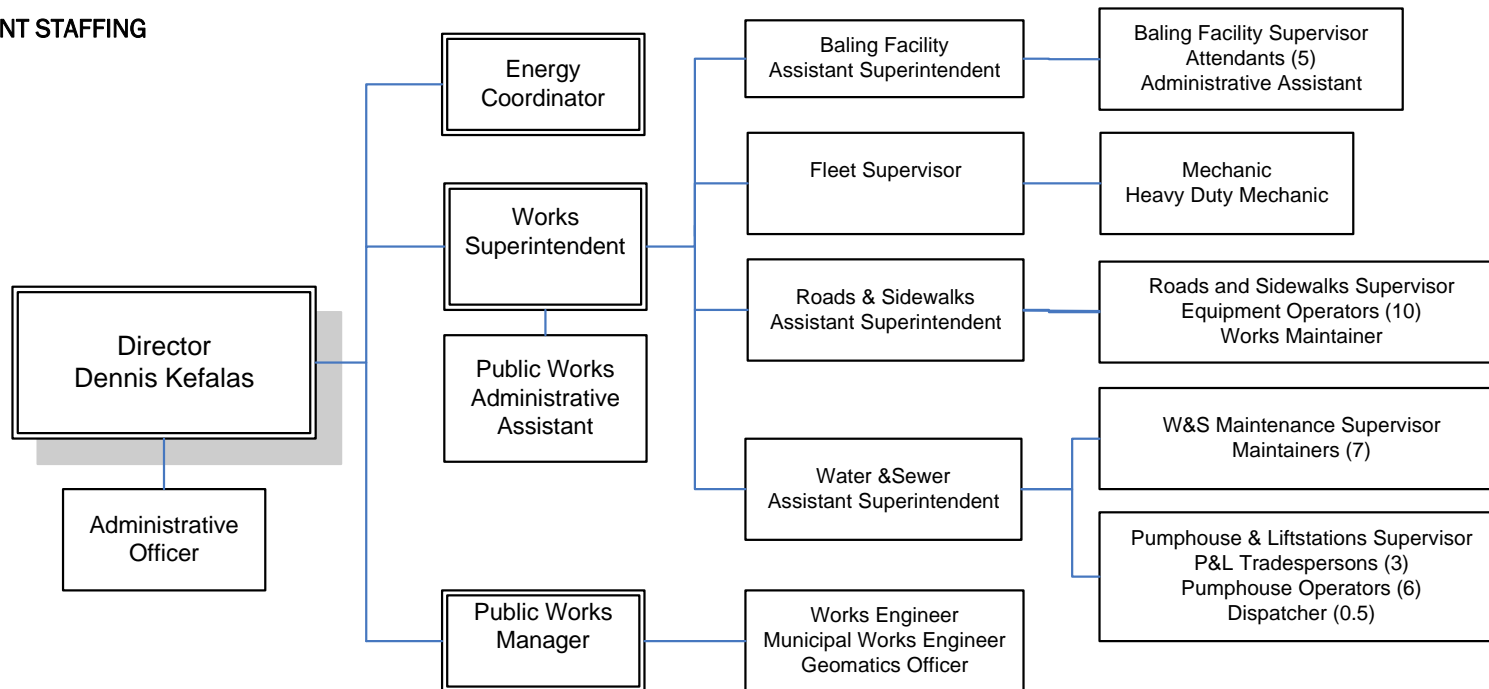

**Staffing Summary**

	2001 Actual	2002 Actual	2003 Actual	2004 Actual	2005 Actual	2006 Actual	2007 Actual	2008 Actual	2009 Actual	2010 Actual	2011 Actual	2012 Budget	2013 Budget	2014 Budget	Note
Directorate	8.33	8.33	8.33	8.33	8.42	8.38	8.36	8.35	8.33	8.00	8.00	8.00	8.00	8.00	
City Garage	3.00	2.00	2.00	3.00	3.00	3.09	3.08	3.18	3.10	3.10	3.34	3.34	3.34	3.34	
Roads and Sidewalks	11.55	11.55	12.22	12.27	12.60	12.26	13.09	14.46	14.54	14.80	14.77	14.54	14.54	14.54	(1)
Solid Waste Mgmt.	6.50	6.83	7.66	7.66	7.33	8.40	8.31	8.39	8.89	8.89	8.39	9.08	9.08	9.08	(2)
Water and Sewer	20.00	20.67	20.00	20.00	20.00	19.79	20.29	20.24	19.81	20.98	20.98	20.75	20.75	20.75	(3)
	<b>49.38</b>	<b>49.38</b>	<b>50.21</b>	<b>51.26</b>	<b>51.35</b>	<b>51.92</b>	<b>53.13</b>	<b>54.62</b>	<b>54.67</b>	<b>55.77</b>	<b>55.48</b>	<b>55.71</b>	<b>55.71</b>	<b>55.71</b>	
Permanent Positions	46.00	46.00	47.00	48.00	48.00	49.00	50.00	51.18	51.18	51.68	51.58	51.58	51.58	51.58	
Part-time/ Casual	3.38	3.38	3.21	3.26	3.35	2.92	3.13	3.44	3.49	4.09	3.90	4.13	4.13	4.13	
	<b>49.38</b>	<b>49.38</b>	<b>50.21</b>	<b>51.26</b>	<b>51.35</b>	<b>51.92</b>	<b>53.13</b>	<b>54.62</b>	<b>54.67</b>	<b>55.77</b>	<b>55.48</b>	<b>55.71</b>	<b>55.71</b>	<b>55.71</b>	

**Note:**

- (1) One Equipment Operator from 2008 onwards.
- (2) Facility Tradesperson in 2008 onwards = .08 PY.
- (3) One full-time dispatcher from April 2010 onwards and the cost is to be shared equally with Fire & Ambulance Division.

### PUBLIC WORKS & ENGINEERING

The Department of Public Works & Engineering strives to provide cost-effective and responsive municipal services to the public within the policies, objectives and budget outlined by City Council. The department delivers programs in three areas – Engineering Division, Works Division and Solid Waste Division.

**The Works Division** carries out the operations and maintenance programs which cover the delivery of basic municipal services, such as piped or trucked sewer and water services to all residents, garbage collection, maintenance and repair of the City's roadways and sidewalks and vehicle maintenance for all City departments.

**The Engineering Division** delivers and administers the City's capital works programs, which include major construction under the water and sanitation program (such as water treatment and sewage disposal facilities), the roads and sidewalks program (new road construction, paving and concrete work), the land development program and the major and minor capital works for other City departments.

**The Solid Waste Division** carries out the disposal of waste in accordance with regulations and facilitates recycling.

### 2011 HIGHLIGHTS

The Public Works & Engineering Department highlights include:

- Provided engineering for the replacement of water and sewer mains and water and sewer services on Knutsen Avenue and a section of Bromley Drive. The total budget was \$2.7 million.
- Provided engineering and management for the construction, reconstruction, and landscaping of Range Lake Road and Woolgar Avenue, as well as the final section of the Old Airport Road reconstruction project. The total budget was approximately \$2.8 million.
- Provided engineering and management services for the second stage of the Niven Lake Phase VII land development project, which included the installation of water and sewer infrastructure, utility infrastructure, and road construction. The total budget was approximately \$4.1 million.

- Provided engineering and management services for the Enterprise Drive Extension land development project. The total budget was approximately \$1.5 million.
- Participated in the Solid Waste Management Advisory Committee.
- Provided engineering and management services for the design and construction of a new landfill cell at the Solid Waste Facility. The total budget was approximately \$3.5 million.
- Completed analysis of existing transit routes and ongoing collection of ridership data.
- Completed water source selection process for the Water Treatment Plant project. Conducted public meetings.
- Provided engineering and management for the Water Treatment Plant design phase, as well as the access road required to develop the site. Tendered the construction for the access road and water main realignment. The total budget for 2011 was approximately \$2.5 million.
- Replaced six traffic light control cabinets, each equipped with UPS units, and effectively managed and maintained the entire traffic light system.
- Provided engineering and technical advice to different departments on various issues that arise on a daily basis.

### 2012/2013/2014 Goals

The goals of the Public Works & Engineering Department are to:

- Provide cost-effective and responsive municipal services to the public within the policies, objectives and budget as outlined by City Council.
- Manage the daily operation and maintenance of the City's infrastructure.
- Manage the capital works program.
- Provide a challenging and rewarding work environment.



### 2012/2013/2014 Objectives

The objectives of the Public Works & Engineering Department are to:

- Review operations and staffing constantly to balance efficiency, effectiveness, job challenges, and work environment.
- Manage operation and maintenance of the City's infrastructure.
- Provide input and staff resources to assist the planning and implementation of Works crew activities.
- Assist in the administration of personnel matters such as commendations, hiring, performance reviews, discipline.
- Enhance and maintain through computer technology an accurate infrastructure database for use by City personnel.
- Provide technical assistance to field personnel in terms of engineering expertise.
- Manage the contracts between the City and the contractors who provide waste collection, sewage pickup, water delivery and public transit services.
- Assess short- and long-range capital infrastructure requirements and prioritize in accordance with Council direction.
- Manage engineering/technical consultant input through requests for proposals and select appropriate firms in accordance with standards set by Council.
- Direct/instruct/guide consultants throughout the pre-design and design work and review all pre-design reports and design/contract documents.
- Draft and revise City contract documents as necessary, to reflect latest developments in Council policies and the law.
- Supervise the tendering process.
- Continue with planning and engineering work on a new water treatment plant and pumphouse.
- Supervise construction through daily contact with consultants and contractors and attendance at all project meetings.
- Avoid costly litigation through daily contact with consultants and contractors and attendance at all project meetings.
- Review and approve progress payments and ensure claims are dealt with in accordance with contract terms.
- Be responsive to public requests and questions.
- Monitor traffic intersections to determine if the level of service requires adjustments.
- Undertake analysis of City streets and record results.



**GENERAL FUND - Public Works & Engineering**

**Department Budget**

	2010 Actual (\$000's)	2011 Budget (\$000's)	2011 Forecast (\$000's)	2012 Budget Recommended (\$000's)	2013 Budget (\$000's)	2014 Budget (\$000's)
<b>Revenue</b>						
Government Transfer						
Other Grants	-	-	-	-	-	-
User Charges	343	361	338	373	380	388
	<u>343</u>	<u>361</u>	<u>338</u>	<u>373</u>	<u>380</u>	<u>388</u>
<b>Expenditures (By Activity)</b>						
Administration	1,002	1,076	1,087	1,096	1,124	1,153
City Garage	682	534	614	575	591	607
Public Transit	1,028	1,062	1,083	1,083	1,116	1,149
Roads & Sidewalks	3,265	3,344	3,475	3,459	3,574	3,675
	<u>5,977</u>	<u>6,016</u>	<u>6,259</u>	<u>6,213</u>	<u>6,405</u>	<u>6,584</u>
<b>Net Revenue (Expenditures)</b>	<u>(5,634)</u>	<u>(5,655)</u>	<u>(5,920)</u>	<u>(5,840)</u>	<u>(6,024)</u>	<u>(6,196)</u>
<b>Expenditures (By Object)</b>						
Wages & Benefits	2,642	2,790	2,877	2,814	2,889	2,970
Other O&M	4,016	3,890	4,282	4,280	4,419	4,542
Internal Recoveries	(681)	(664)	(899)	(881)	(903)	(928)
	<u>5,977</u>	<u>6,016</u>	<u>6,259</u>	<u>6,213</u>	<u>6,405</u>	<u>6,584</u>



**GENERAL FUND - Public Works & Engineering**

**Directorate Budget**

		2010	2011	2011	2012	2013	2014
		Actual	Budget	Forecast	Budget	Budget	Budget
		(\$000's)	(\$000's)	(\$000's)	Recommended	(\$000's)	(\$000's)
					(\$000's)		
<b>Revenue</b>							
	User Charges	-	-	-	-	-	-
		-	-	-	-	-	-
<b>Expenditures (By Activity)</b>							
	Legislation & Governance	100	108	109	110	112	115
	Capital Planning	140	151	152	153	157	161
	Project Management	150	161	163	164	169	173
	Roads & Sidewalks	251	269	272	274	281	288
	Water & Sewer	200	215	217	219	225	231
	Public Transit	50	54	54	55	56	58
	Drafting	110	118	120	121	124	127
		1,002	1,076	1,087	1,096	1,124	1,153
<b>Net Revenue (Expenditures)</b>		(1,002)	(1,076)	(1,087)	(1,096)	(1,124)	(1,153)
<b>Expenditures (By Object)</b>							
	Wages & Benefits	950	1,024	1,027	1,043	1,070	1,098
	Other O&M	52	52	60	53	54	55
		1,002	1,076	1,087	1,096	1,124	1,153

### CITY GARAGE

#### 2011 Highlights

The highlights of City Garage operations include:

- Purchased equipment for the fleet (lawn mower, five half-tons, highway tractor, roll-off truck, a grader, fire pumper truck, and an MED car).
- Continued to integrate WorkTech system to better track Public Works activities.
- Completed many Occupational Health and Safety/Fire Code updates at the City Garage.
- Implemented safe work practices for Public Works crews and completed the third edition of “City of Yellowknife Public Works & Engineering Safe Work Practices, Policies and Procedures”.
- Restructured Public Works services, placing Solid Waste Facility under Operations and Maintenance.
- Operations and Maintenance division underwent a review by an efficiency expert.
- Equipment maintenance schedule was altered to meet Original Equipment Manufacturing Standards and the challenges of staff shortages. Arrangement made with local contractor to take on overflow.
- Increased maintenance standards on fire equipment to meet National Fire Code—this work is now contracted out.
- Deferred purchase of two snowmobiles by one year, and planned for this fall.
- Re-leveled Pine Point shop.
- Developed and updated service standards.
- Hired casual mechanics to help with maintenance tasks.
- Updated two gensets (City Hall and Yellowknife Arena).
- Updated fuel monitoring program to produce more meaningful reports.
- Upgraded training room to reduce distractions during training sessions.

#### 2012/2013/2014 Goals

The goals of the City Garage are to:

- Maintain the City’s fleet and stationary equipment such as standby generators in proper working condition.
- Shelter the City’s fleet and properly maintain the City Garage, Stores, Carpentry and Mechanics’ shops, Operations and Maintenance offices and training room.
- Provide regular repairs and preventative maintenance service by qualified mechanics for City’s mobile equipment. Investigate operating the Equipment Shop on a cost centre approach, under which mobile equipment would have an internal rental rate.
- Monitor contractor repairs done at request of user departments to ensure value for dollars.
- Provide a base for the various Public Works divisions by:
  - Stockpiling granular materials.
  - Having an inventory control area.
  - Using vehicle fuel fobs and employee ID cards to track fuel consumption by vehicle and department.
- Track operational costs to better identify opportunities for improvements.

#### 2012/2013/2014 Objectives

The objectives of the City Garage are to:

- Provide preventative and service maintenance to all City vehicles on a timely and cost-effective basis. Check and service all equipment and light vehicles by master schedule and capacity plan as a means of preventative maintenance. During such checks, mechanics shall examine tie rod ends, ball joints, exhaust systems, “U” joints, leaky seals, fluid levels, lights, tires, and front end alignment.
- Provide priority maintenance to emergency vehicles.
- Service diesel pumps and generators located at City facilities annually (including City Hall, Fire Hall, Multiplex, Ruth Inch Memorial Pool, Yellowknife Community Arena, pumphouses and liftstations, and City Garage) as per CSA Standards.



## GENERAL FUND - Public Works & Engineering

---

- Provide equipment and labour to City departments on an as-required basis.
- Maintain accurate records of fuel consumption by City vehicles and encourage fuel conservation through reduced use, education, and instilling a “turn it off” attitude.
- Maintain accurate records of parts and labour expended to service City equipment, and recover these costs from the receiving departments where applicable.
- Maintain fleet gas and diesel fuel pumps, tanks and other accessories in good operating condition, and fill fuel tanks as required.
- Provide a healthy, safe, and challenging work environment that promotes pride in workmanship.
- Meet requirements found in an Occupational Health and Safety audit of buildings surrounding Garage.
- Implement, where practical, the suggestions made by the consultant in the operational review.

**GENERAL FUND - Public Works & Engineering**

<b>City Garage Budget</b>								
		2010 Actual (\$000's)	2011 Budget (\$000's)	2011 Forecast (\$000's)	2012 Budget Recommended (\$000's)	2013 Budget (\$000's)	2014 Budget (\$000's)	Note
<b>Revenue</b>								
	Government Transfer							
	Other Grants	-	-	-	-	-	-	
<b>Expenditures (By Activity)</b>								
	Fleet Repair & Maintenance	1,175	1,020	1,316	1,263	1,298	1,337	
	Maintenance Costs Allocated	(681)	(664)	(899)	(881)	(903)	(928)	(1)
	Garage/Yard Maintenance	161	154	167	164	166	167	
	Standby Generator Maintenance	27	24	30	29	30	31	
		<u>682</u>	<u>534</u>	<u>614</u>	<u>575</u>	<u>591</u>	<u>607</u>	
<b>Net Revenue (Expenditures)</b>		<u>(682)</u>	<u>(534)</u>	<u>(614)</u>	<u>(575)</u>	<u>(591)</u>	<u>(607)</u>	
	Wages & Benefits	358	337	371	345	354	364	
	Other O&M	1,005	861	1,142	1,112	1,140	1,171	
	Maintenance Costs Allocated	(681)	(664)	(899)	(881)	(903)	(928)	(1)
		<u>682</u>	<u>534</u>	<u>614</u>	<u>575</u>	<u>591</u>	<u>607</u>	

**Note**

(1) This represents the vehicle O&M and fuel costs to be incurred by Fleet Management on behalf of other departments. The costs will be re-allocated to other departments.



### PUBLIC TRANSIT

#### 2011 Highlights

The Public Transit highlights for 2011 include:

- Continued to place advertising on the exterior of regular transit buses.
- Continued the Accessible Transit System through a dedicated bus.
- Provided free bus service on Clean Air Day and Earth Day.
- Posted schedules for Folk on the Rocks busing at regular bus stops.
- Gave out free passes at special events to encourage the use of public transportation.
- Repaired bus shelters. Vandalism in the city continues to be a concern.
- Provided twice-weekly Golf Club shuttle during July and August.

#### 2012/2013/2014 Goals

The goals of Public Transit are to:

- Increase public transit system ridership and reliability.
- Increase public transit ancillary services such as signage and schedule availability.
- Promote public transit as an alternative to an individual driving an otherwise empty vehicle.
- Increase public transit revenues by selling advertising space on the buses.

#### 2012/2013/2014 Objectives

The objectives of Public Transit are to:

- Conduct monthly quality control meetings with the public transit contractor and school boards.
- Review transit routes, schedules and fares yearly, and implement amendments as necessary.
- Market the city's transit system to the public and various agencies throughout the city, with the objective of increasing revenues.

- Market advertising space on the buses with the objective of increasing total public transit revenues.
- Review public complaints and suggestions and work with contractor to remedy them.
- Carry out regular customer surveys.
- Manage the City's contract for the provision of public transit and monitor service provided (quality of service, invoicing, timing, condition of equipment, etc).
- Maintain public transit-related facilities in good and clean condition (shelters, signs, posted schedules, advertising, etc.)
- It is anticipated that transit service will expand into the Niven area once the roads have been paved. Increases in service are expected for September 2012.

## GENERAL FUND - Public Works & Engineering

Public Transit Budget		2010	2011	2011	2012	2013	2014
		Actual	Budget	Forecast	Budget	Budget	Budget
		(\$000's)	(\$000's)	(\$000's)	Recommended	(\$000's)	(\$000's)
<b>Revenue</b>							
	Government Transfer	-	-	-	-	-	-
	Other Grants	-	-	-	-	-	-
	User Charges	343	361	338	373	380	388
		<u>343</u>	<u>361</u>	<u>338</u>	<u>373</u>	<u>380</u>	<u>388</u>
<b>Expenditures (By Activity)</b>							
	Transit Operations	1,028	1,062	1,083	1,083	1,116	1,149
<b>Net Revenue (Expenditures)</b>		<u>(685)</u>	<u>(701)</u>	<u>(745)</u>	<u>(710)</u>	<u>(735)</u>	<u>(761)</u>
<b>Expenditures (By Object)</b>							
	Wages & Benefits	-	-	-	-	-	-
	Other O&M	1,028	1,062	1,083	1,083	1,116	1,149
		<u>1,028</u>	<u>1,062</u>	<u>1,083</u>	<u>1,083</u>	<u>1,116</u>	<u>1,149</u>

Public Transit Performance Measures	Projected 2010	Actual 2010	Projected 2011	Forecasted 2012	Forecasted 2013	Forecasted 2014	Notes
<b>Workload Indicators</b>							
No. of hours bus service provided	9,200	9,200	9,200	15,400	15,400	15,400	(1)
Annual ridership based on revenue	191,000	193,000	194,000	201,000	210,000	215,000	(2)
No. of hours accessible transit was provided	3,900	3,900	3,900	4,000	4,000	4,000	(3)
Annual ridership on accessible transit based on revenue	6,000	6,995	6,000	6,000	6,000	6,000	
<b>Efficiency Measures</b>							
Annual subsidized cost per capita	\$33.41	\$34.37	\$36.93	\$34.79	\$35.61	\$36.46	(4)
Annual revenue/cost ratio	0.35	0.33	0.31	0.34	0.34	0.34	(5)
Annual subsidized cost per capita (accessible transit)	\$9.81	\$9.78	\$9.81	\$9.92	\$9.92	\$9.92	(6)
Annual revenue/cost ratio (accessible transit)	0.05	0.06	0.07	0.07	0.07	0.07	(7)
<b>Effectiveness Measures</b>							
% of users very satisfied or somewhat satisfied with the overall transit system	70%	70%	-	75%	-	77%	(8)

### Notes:

- (1) Service to Niven Lake subdivision anticipated for September 2012
- (2) The ridership in 2007 was 162,000.
- (3) Accessible transit started in September of 2005.
- (4) The national average for Yellowknife's population group according to the Canadian Urban Transportation Association was \$28.18 in 2008.
- (5) The national average for Yellowknife's population group according to the Canadian Urban Transportation Association was 0.36 in 2008.
- (6) The national average for Yellowknife's population group according to the Canadian Urban Transportation Association was \$9.91 in 2008.
- (7) The national average for Yellowknife's population group according to the Canadian Urban Transportation Association was 0.16 in 2008.
- (8) According to a Transit Survey in 2009, 88% were satisfied or somewhat satisfied with the overall transit service. In 2003, 75% were satisfied in Yellowknife.



### ROADS & SIDEWALKS

#### 2011 Highlights

The highlights for the Roads & Sidewalks Division include:

- Reduction of dust (airborne particles) through:
  - Timely snow removal including downtown alleys and City-owned parking lots.
  - Concentrated effort of street sweeping in the spring and summer using three sweepers during peak time and one sweeper during the summer, in order to reduce windblown litter and debris buildup.
  - Hand sweeping of City-owned sidewalks.
  - Use of calcium chloride on gravel roads and alleys for dust control.
- Clearing snow and applying ice melt on Franklin Avenue alleyways, intersections, sidewalks, City bus shelters and sidewalks adjacent to City properties.
- Maintenance and repair of 80.3 km of paved and chip sealed roads and 25 km of gravel roads.
- Maintenance and repair of 18 sets of traffic lights.
- Maintenance and repair of 2,462 traffic signs and 340 parking meters. Fabrication and repair of pedestrian crossing lights and pedestrian crossing buttons.
- Provision of construction equipment to Water & Sewer Division as required for replacement of water and sewer services, water and sewer mains, as well as the fixing of water breaks and surface water lines.
- Provision of construction equipment to Community Services Department as required for cemetery services and park maintenance.
- Installation of new signs and barriers.
- Maintenance and repairs to City storm sewer system.
- Pruning trees of obstructive and unsafe branches/limbs hanging over sidewalks and roads.
- Resurface gravel roads when needed.
- Supply materials and equipment to assist Giant Mine Heritage Association.
- Painting curbs for no parking zones on corners and by fire hydrants in the downtown area.
- Clean brush from ditches to promote positive drainage.
- Camera boat launch landing pads to inspect for wash-outs at ramps end.
- Supply crew to perform pavement stamping at Somba K'e Park.
- Carrying out spring and fall cleanup by picking up bulky waste at residents request.
- Maintenance of the sewage lagoon including the construction of new cells for honey bags and coverage for existing cells.
- Installation and removal of the floating curtain under the McMeekan Causeway in order to promote ice formation.
- Installation and removal of dock at City boat launch.
- Assist and supply equipment and materials to City Solid Waste Facility as needed.
- Provision of support to special events such as the Santa Claus Parade, Canada Day Parade, Aboriginal Day, Terry Fox Run, Run for the Cure, etc.
- Installation of Christmas silhouettes downtown.
- Installation and repair of Christmas lights and banners on streetlights on Old Airport Road, Wiley Road and in downtown core.
- Maintenance and repair of 28 City bus shelters including cleaning and glass replacement, as well as the installation of new shelters and bus routes. Vandalism continues to be a problem.
- Cleaning up Kam Lake boat launch and surrounding area for annual fishing derby.
- Resurfacing or replacing city sidewalks that were in poor shape, especially downtown, and performing yearly inspections.
- Cleaning up or assisting in cleanup of any oil contaminants on city streets and properties.
- Repair and maintenance of Giant Mine boat launch and access road.
- Perform water sampling on all storm outfalls twice a year.
- Continue to repair small potholes and asphalt surface breakage with cold mix.
- Clean up area of Esso bulk station.
- Paint older faded bus shelters.
- Provide line painting throughout the City for public safety.
- Perform crack sealing on asphalt surfaces to prolong asphalt life expectancy.
- Replace two bus shelters on Finlayson Drive.



### 2012/2013/2014 Goals

The goals for the Roads & Sidewalks Division are to:

- Provide safe roads for residents.
- Provide equipment and labour to other divisions and departments when required (especially Water & Sewer).
- Provide winter road maintenance and snow removal.
- Provide street sweeping and dust control services to reduce airborne dust particles.
- Maintain storm drain system.
- Maintain signs, traffic lights, and bus shelters.
- Provide a safe, team-oriented atmosphere for Roads & Sidewalks employees.

### 2012/2013/2014 Objectives

The objectives for the Roads & Sidewalks Division are to:

- Monitor work performance via WorkTech to determine most efficient use of labour and equipment.
- Promote safe work procedures.
- Promote vehicle inspections by operators to maintain control of breakdown repairs.
- Provide year-round 24-hour callout services.



GENERAL FUND - Public Works & Engineering

Roads and Sidewalks Budget

	2010 Actual (\$000's)	2011 Budget (\$000's)	2011 Forecast (\$000's)	2012 Budget Recommended (\$000's)	2013 Budget (\$000's)	2014 Budget (\$000's)
<b>Revenue</b>						
User Charges	-	-	-	-	-	-
<b>Expenditures (By Activity)</b>						
Snow & Ice Control	777	996	854	824	845	867
Street Maintenance	529	505	589	572	587	602
Street Sweeping	93	99	107	100	103	105
Storm/Ditch Maintenance	159	177	185	170	174	180
Traffic Signals/Lighting/Marking	1,112	1,073	1,083	1,164	1,222	1,257
	2,669	2,849	2,819	2,829	2,930	3,011
Labour & Equipment Allocation	(1,063)	(1,209)	(1,199)	(1,140)	(1,170)	(1,204)
	1,606	1,640	1,620	1,689	1,760	1,806
<b>Net Revenue (Expenditures)</b>	(1,606)	(1,640)	(1,620)	(1,689)	(1,760)	(1,806)
<b>Expenditures (By Object)</b>						
Wages & Benefits	1,334	1,429	1,478	1,426	1,464	1,508
Other O&M	1,931	1,915	1,997	2,033	2,110	2,167
	3,265	3,344	3,475	3,459	3,574	3,675

### SNOW & ICE CONTROL

#### 2012/2013/2014 Goals

The Snow & Ice Control Division goals are to:

Provide a cost-effective, safe, and reliable municipal transportation system during the winter months through the use of three primary activities: snowplowing, road sanding, and snow removal.

#### 2012/2013/2014 Objectives

The Snow & Ice Control Division objectives are to:

- Remove snow from major thoroughfares and intersections before ice and snow accumulations cause the roadway to become unsafe.
- Remove snow from residential streets, sidewalks, and alleys at least once a year and remove snow from the downtown streets and sidewalks at least twice a year.
- Update road priority system annually, especially as new City streets are added.
- Maintain paved roads through snow removal, plowing, and sanding.
- Maintain gravel roads through grading, snow clearing and sanding.
- Tender winter street sand annual requirements to get balance between cost, preferred rock type, and public satisfaction with road sanding.
- Maintain City facility roads and parking lots, including snow removal from the Fire Hall, City Hall, pool, pumphouses, liftstations, arenas, Fieldhouse, cemetery, and at Pumphouse #2 located at the Yellowknife River.
- Use of road salt mixture in treacherous conditions in spring and fall on major intersections to reduce ice build-up.
- Provide 24-hour call-out service for snowstorms or slippery roads.
- Clear City-owned sidewalks of snow and ice.
- Remove snow and apply salt at City bus shelters.
- Apply salt to sidewalks at alley entrances to reduce ice build-up in downtown core along Franklin Avenue.



GENERAL FUND - Public Works & Engineering

---

Snow and Ice Control Budget

	2010 Actual (\$000's)	2011 Budget (\$000's)	2011 Forecast (\$000's)	2012 Budget Recommended (\$000's)	2013 Budget (\$000's)	2014 Budget (\$000's)
<b>Snow Removal/Clearing</b>						
Contracted Services	57	66	66	68	69	70
Materials	12	3	3	3	3	3
	69	69	69	71	72	73
Equipment	149	122	176	161	165	170
Labour	288	375	319	308	316	325
	506	566	564	539	553	568
<b>Winter Sanding</b>						
Contracted Services	-	-	-	-	-	-
Materials	183	190	190	190	194	198
	183	190	190	190	194	198
Equipment	28	18	33	30	31	32
Labour	61	221	67	65	67	69
	271	430	290	285	292	299
	777	996	854	824	845	867

## GENERAL FUND - Public Works & Engineering

---

### Snow & Ice Control Performance Measures

	Projected 2010	Actual 2010	Projected 2011	Forecasted 2012	Forecasted 2013	Forecasted 2014	Notes
<b>Workload Indicators</b>							
Annual snowfall (cm)	155	124.8	155	155	155	155	(1)
<b>Efficiency Measures</b>							
Cost per km of snow removed and cleared on roads and city streets	\$8,323	\$7,274	\$8,498	\$8,656	\$8,869	\$9,090	(2)

**Notes:**

- (1) Annual Snowfall:
- |             |          |
|-------------|----------|
| 2002        | 130.2 cm |
| 2003        | 137.0 cm |
| 2004        | 160.2 cm |
| 2005        | 192.1 cm |
| 2006        | 176.6 cm |
| 2007        | 144.8 cm |
| 2008        | 199.0 cm |
| 2009        | 174.1 cm |
| Actual 2010 | 124.8 cm |
- (2) Cost per kilometre includes ice control (winter sanding).



### STREET MAINTENANCE

#### 2012/2013/2014 Goals

The goals of the Street Maintenance Division are to:

- Provide safe travel for our pedestrian and vehicular residents within the City in a cost-effective manner.
- Maintain all roads and sidewalks in a reasonable operating condition.
- Carry out line painting and road markings to reduce contracted costs.
- Perform crack sealing to asphalt surfaces to reduce contracted costs.
- Provide equipment operations for other Public Works & Engineering divisions and City departments where needed in a timely, efficient, and cost-effective manner.

#### 2012/2013/2014 Objectives

The Objectives of the Street Maintenance Division are to:

- Inspect roads, streets and sidewalks regularly to determine which areas require repairs or maintenance and ensure their repair on a priority basis.
- Provide emergency 24-hour call-out services for road maintenance/repairs throughout the year.
- Maintain paved roads through pothole patching, crack sealing, and reconstruction.
- Maintain gravel roads through grading, resurfacing, reconstruction, and the application of dust suppressant.
- Work closely with the Engineering Division so that Roads & Sidewalks staff can prepare more patches while lowering the costs of having a paving contractor carry out this task.

**GENERAL FUND - Public Works & Engineering**

**Street Maintenance Budget**

		2010 Actual (\$000's)	2011 Budget (\$000's)	2011 Forecast (\$000's)	2012 Budget Recommended (\$000's)	2013 Budget (\$000's)	2014 Budget (\$000's)
<b>Dust Control</b>							
	Contracted Services	-	-	-	-	-	-
	Materials	56	30	30	33	35	36
		56	30	30	33	35	36
	Equipment	10	11	12	11	11	11
	Labour	54	22	59	57	59	61
		119	63	101	101	105	108
<b>Gravel Road Maintenance</b>							
	Contracted Services	-	-	-	-	-	-
	Materials	13	17	17	17	17	18
		13	17	17	17	17	18
	Equipment	16	24	19	17	17	18
	Labour	32	51	35	34	35	36
		60	92	70	68	69	72
<b>Paved Road Maintenance</b>							
	Contracted Services	160	150	150	153	156	159
	Materials	27	70	85	72	74	76
		187	220	235	225	230	235
	Equipment	8	2	10	9	9	10
	Labour	73	42	81	78	80	82
		268	264	326	312	319	327
<b>Sidewalk Maintenance</b>							
	Contracted Services	45	45	45	46	47	48
	Materials	4	10	10	10	10	11
		49	55	55	56	57	59
	Equipment	7	4	8	7	8	8
	Labour	26	28	29	28	29	30
		82	87	92	91	93	96
		529	505	589	572	587	602



## GENERAL FUND - Public Works & Engineering

### Street Maintenance Performance Measures

	Projected 2010	Actual 2010	Projected 2011	Forecasted 2012	Forecasted 2013	Forecasted 2014	Notes
<b>Workload Indicators</b>							
Kms of paved roads -- 4 lane	3.9	3.9	3.9	3.9	3.9	3.9	
Kms of paved roads -- 2 lane	62.9	62.9	63.7	64.2	65.5	66.3	
Kms of paved alleys -- 1 lane	7.6	7.6	7.6	7.6	7.6	7.6	
Kms of unpaved roads -- 2 lane	26.5	26.5	26	25.9	24.6	23.8	
Kms of unpaved alleys -- 1 lane	16	16	16	16	16	16	
Total	116.9	116.9	117.2	117.6	117.6	117.6	
Kms of roads reconstructed and new roads	5.0	5.0	1.9	1.0	2.0	1.4	(1)
<b>Efficiency Measures</b>							
Cost per km maintained -- road/alley	\$4,329	\$4,525	\$5,026	\$4,864	\$4,991	\$5,119	
<b>Effectiveness Measures</b>							
% of citizens very satisfied or somewhat satisfied with summer road maintenance	63%	63%	-	65%	-	67%	(2)

#### Notes:

- (1) 2008 Reconstruct 49th Avenue (389 m) and 44th Street (143 m)  
 2008 New Roads FOL Road (2.8 kms)  
 2009 Reconstruct Kam Lake Road (500 m), Old Airport Road (350 m), and 50th Street (145 m)  
 2009 New Roads Engle Business District (3 kms)  
 2010 Reconstruct McDonald Drive (472 m), and pave Haener Drive (535 m)  
 2010 New Bypass Road (4 km) gravel  
 2011 Reconstruct Old Airport Road, Borden Drive to Cemetery Road (787 m)  
 2011 Pave Drybones Drive (232 m), Ndilo (562 m), Moyle Drive Extension (330 m)  
 2012 Ndilo (538 m), Enterprise Drive Extension (470 m)  
 2013 Pave DeWeerd Drive (335 m), Driscoll Road (104 m)  
 2013 Reconstruct Deh Cho Blvd (1.17 km), pave Raccine Road (148 m), Ingraham Drive (187 m), Doornbos Lane (55 m)  
 2014 Pave Cemetery Road (460 m), 41A Street (210 m), 49th Avenue (104 m)  
 2014 Reconstruct 52nd Avenue, from 49th Street to 56th Street (613 m)
- (2) A higher proportion of residents were satisfied in 2007 (75%).



### STREET SWEEPING

The highlights of 2011 street sweeping are to:

- Sweep downtown core on weekends and holidays to further reduce debris build up.

### 2012/2013/2014 Goals

The goals of the Street Sweeping Division are to:

- Carry out spring clean-up activities with the intent of reducing dust generation.
- Reduce dust generation through investigation and trial of alternative technologies and methods.

### 2012/2013/2014 Objectives

The objectives of the Street Sweeping Division are to:

- Remove dust and debris from streets as quickly as practical, particularly following spring thaw, to reduce suspended particles in the air. The level of dust has decreased in the past few years as evaluated by the GNWT and documented in their Air Quality Report (ENR).
- Continue to sweep throughout summer to minimize build-up of gravel and debris on City streets.
- The City has purchased a new street sweeper with a vacuum system to reduce dust generated when street sweeping.



**GENERAL FUND - Public Works & Engineering**

---

**Street Sweeping Budget**

		2010 Actual (\$000's)	2011 Budget (\$000's)	2011 Forecast (\$000's)	2012 Budget Recommended (\$000's)	2013 Budget (\$000's)	2014 Budget (\$000's)
<b>Street Sweeping</b>							
	Contracted Services	-	-	-	-	-	-
	Materials	3	6	6	3	3	3
		3	6	6	3	3	3
	Equipment	28	29	33	30	31	31
	Labour	63	64	69	67	69	71
		93	99	107	100	103	105

**Street Sweeping Performance Measures**

	Projected 2010	Actual 2010	Projected 2011	Forecasted 2012	Forecasted 2013	Forecasted 2014
<b>Workload Indicators</b>						
Total paved roads/alleys (kms)	74.4	74.4	75.2	75.7	77	77.8
<b>Efficiency Measures</b>						
Cost per km to street sweep	\$1,277	\$1,250	\$1,423	\$1,321	\$1,338	\$1,350

Sweeping includes parking lots  
Sweeping 7 days a week

### STORM/DITCH MAINTENANCE

#### 2011 Highlights

The highlights for Storm/Ditch Maintenance include:

- Cleared debris, cut and sloped trenches to promote positive water flow at major outfalls.
- Cleared debris from open ditches to promote positive water flow.
- Marked culvert ends to reduce damage in spring when location of the ends of culverts is necessary.
- Maintained and installed plates with fish symbols to raise public awareness that what goes into the city's ditches or storm sewers goes to our lakes and affects aquatic life.

#### 2012/2013/2014 Goals

The goal of the Storm/Ditch Maintenance Division is to:

- Maintain a well-drained storm sewer system including ditches and storm sewers to promote positive drainage.

#### 2012/2013/2014 Objectives

- Flush the underground storm sewer system annually, and repair or replace any damaged or defective structural components.
- Remove overgrown vegetation and accumulated sediment and debris from system.
- Carry out maintenance and thawing of storm sewers as required.
- Upgrade ditching in the Kam Lake Industrial Park by providing new ditching and drainage where necessary.



GENERAL FUND - Public Works & Engineering

---

Storm/Ditch Maintenance Budget

	2010 Actual (\$000's)	2011 Budget (\$000's)	2011 Forecast (\$000's)	2012 Budget Recommended (\$000's)	2013 Budget (\$000's)	2014 Budget (\$000's)
<b>Ditch Maintenance</b>						
Contracted Services	12	11	11	11	11	11
Materials	2	3	3	3	3	4
	14	14	14	14	14	15
Equipment	9	10	11	10	10	11
Labour	26	35	28	27	28	29
	48	59	53	51	52	55
<b>Storm Sewer Maintenance</b>						
Contracted Services	4	12	12	5	5	5
Materials	20	23	23	21	21	22
	24	35	35	26	26	27
Equipment	12	10	15	13	14	14
Labour	74	73	82	79	82	84
	110	118	132	118	122	125
	159	177	185	170	174	180

### TRAFFIC SIGNALS/LIGHTING/MARKING

#### 2011 Highlights

The Traffic Signals/Lighting/Marking Division highlights include:

- Traffic light controllers at six intersections were updated. All intersections now have backup power.

#### 2012/2013/2014 Goals

The goals of the Traffic Signals/Lighting/Marking Division are to:

- Carry out yearly inspections of traffic lights.
- Maintain traffic control systems in good operating condition.
- Improve traffic flow along Franklin Avenue between Old Airport Road and the Central Business District by coordinating the timing of traffic lights.
- Improve communication and detection with problem intersections.
- Update traffic light controllers and software.

#### 2012/2013/2014 Objectives

The objectives of the Traffic Signals/Lighting/Marking Division are to:

- Install signs within the city in accordance with relevant standards and legislation.
- Carry out traffic counts to determine modifications to existing intersections.
- Install and maintain all traffic control systems.
- Inspect city streetlights on a regular basis and notify the utility company of problems.
- Coordinate the hanging of banners and Christmas decorations in the city.
- Administer the closure of roads for special events.
- Establish truck routes within the city limits.
- Perform street line painting as required on an annual basis.
- Repaint traffic light poles when necessary.

- Identify locations and install pedestrian crosswalks.
- Improve traffic circulation by revising timing to traffic light programming.
- Carry out Global Positioning System of all street signs for location and tracking.



GENERAL FUND - Public Works & Engineering

Traffic Signals/Lighting/Marking Budget

		2010 Actual (\$000's)	2011 Budget (\$000's)	2011 Forecast (\$000's)	2012 Budget Recommended (\$000's)	2013 Budget (\$000's)	2014 Budget (\$000's)
<b>Line Painting</b>							
	Contracted Services	-	-	-	-	-	-
	Materials	20	15	20	15	16	16
		20	15	20	15	16	16
	Equipment	2	1	2	2	2	2
	Labour	29	17	32	31	32	33
		51	32	54	48	50	51
<b>Sign Maintenance</b>							
	Contracted Services	-	2	2	1	1	1
	Materials	21	16	16	16	17	17
		21	18	18	17	18	18
	Equipment	4	2	4	4	4	4
	Labour	36	33	39	38	39	40
		60	53	62	59	61	62
<b>Street Decorating</b>							
	Contracted Services	23	14	14	14	14	15
	Materials	4	11	11	8	9	9
		27	25	25	22	23	24
	Equipment	5	3	6	5	5	5
	Labour	17	11	19	18	19	19
		48	39	50	45	47	48
<b>Traffic &amp; Street Lighting</b>							
	Contracted Services	35	23	23	23	24	24
	Power - Street lights	881	900	858	947	999	1,029
	Power - Traffic lights	25	23	25	30	30	31
		942	946	906	1,000	1,053	1,084
	Equipment	1	-	2	2	2	2
	Labour	9	4	10	10	10	11
		952	949	918	1,012	1,065	1,097
		1,112	1,073	1,083	1,164	1,222	1,257

## GENERAL FUND - Public Works & Engineering

---

### Traffic Signals/Lighting/Marking Performance Measures

	Projected 2010	Actual 2010	Projected 2011	Forecasted 2012	Forecasted 2013	Forecasted 2014	Notes
<b>Workload Indicators</b>							
Street Lights	1,526	1,526	1,540	1,540	1,540	1,540	(1)
Traffic Lights	18	18	18	18	18	18	(2)
Pedestrian Crosswalks	7	7	7	7	7	7	
<b>Efficiency Measures</b>							
Average yearly energy cost for street lighting	\$880,000	\$881,000	\$858,000	\$947,000	\$999,000	\$1,029,000	
Average yearly energy cost for traffic lights	\$22,000	\$25,000	\$25,000	\$30,000	\$30,000	\$31,000	(3)
% of citizens satisfied or very satisfied with residential street lighting	-	-	-	92%	-	93%	(4)

**Notes:**

- (1) Niven Lake Phase VII constructed summer 2011.
- (2) The traffic lights are in sets, therefore 18 sets of traffic lights totals 87 traffic lights.
- (3) LED light installation completed in 2008, intersections to be metered. Actual power cost was reduced from \$83,000 in 2008 to \$38,500 in 2009.
- (4) This question will be asked every two years. The 2006 survey showed 92% of citizens were satisfied.



### COMMUNITY ENERGY PLAN

According to the 2004 Energy Profile Yellowknife as a whole spends an estimated \$114 million on energy annually and boasts a per capita emissions level of almost twice the national average. Within the framework of rising fuel prices and Canada's commitment to reduce emissions, the City has developed a Community Energy Plan (CEP) that was adopted by Council in 2006. The scope of the CEP includes a focused effort to reduce emissions and energy use within City operations and to support the community in its effort to do the same. The City has allocated \$500,000 of its Gas Tax Funding to support the implementation of the CEP.

#### 2011 Highlights

Highlights of the Community Energy Plan include:

- In 2011 the Community Energy Plan focused primarily on developing the community energy system to heat downtown buildings. The process built off the 2010 completed investment analysis.
  - A referendum was held requesting permission for the City to borrow funds to develop the project, resulting in the public rejecting the request. The process attracted significant public engagement.
  - An alternative financing structure was developed resulting in a Memorandum of Understanding being signed with Corix Utilities to design, construct, operate and finance the system, under a concessional agreement with the City. The City will have a contractual relationship with end customers and Corix will manage all assets connected to the buildings. The final agreement was to be finalized in late 2011.
  - System policy development was completed, including a full day workshop with Mayor and Council.
  - The preliminary design process was completed. Detailed design was scheduled to begin after the definitive agreement was signed with Corix in late 2011.
  - The environmental regulatory process was initiated with the submission of the project's water licence which is required to develop the mine energy component of the system.
- A detailed mine resource assessment was initiated with the selection of VITO, a Belgium-based research team. VITO were involved in the development of the Herleen, Netherland's mine energy project. The work will bring the mine evaluation to an investment grade analysis to confirm the mine will be connected to the community energy system.
- A follow up community energy profile was initiated. The process builds on the 2004 energy baseline work and will be used to track the progress of the Community Energy Plan. This is the final step in the City's Partners for Climate Protection five-step process.
- The City worked with Northland Utilities to test 20 LED streetlights in four residential street locations. The intent of the pilot program was to confirm the technology can meet roadway standards, examine their overall performance and identify preferred suppliers.
- Facility managers completed a number of small energy efficiency projects including a lighting upgrade at the Baling Facility.

#### 2012/2013/2014 Goals

The goals of the Community Energy Plan are to:

- Reduce City operations emissions by 20% by 2014 over 2004 levels, by improving energy efficiency and adopting renewable energy for municipal operations.
- Support the community in its effort to reduce emissions by 6% by 2014 over 2004 levels.
- Reduce City operational energy use by 10% by 2014 over 2004 levels.
- Actively support the development of alternative energy markets including wood pellet and solar heating.
- Develop a downtown Community Energy System.
- Examine waste wood to energy opportunities at the Solid Waste Facility.
- Work with City facility managers to continuously improve the energy performance and monitoring of their facilities.



## GENERAL FUND - Public Works & Engineering

---

- Develop the Community Energy System with Corix Utilities which will include:
  - Working with Corix to ensure the system design best represents the present and future needs of the community,
  - Refining our understanding of the mine resource through continued due diligence,
  - Customer relations interfacing and rate design,
  - Establishing Public Utility Board approval for the rate, and
  - Public outreach to explain the project and facilitate construction implementation.
- Develop the business case to utilize waste wood in the Baling Facility wood boiler.
- Upgrade to more energy-efficient lighting in the Curling Club and arenas.
- Support the upgrade to more energy-efficient options during capital projects such as heat recovery in the Ruth Inch Memorial Pool air handling unit, and increased insulation during the facility's roof replacement.



## SOLID WASTE MANAGEMENT FUND

---

### SOLID WASTE MANAGEMENT FUND

The Solid Waste Division carries out the disposal of waste in accordance with regulations and facilitates recycling.

#### 2011 Highlights

- Processing, baling, and landfilling of approximately 30,000 cubic metres of waste.
- Started shaping areas of the landfill to final contours in preparation for landfill closure.
- Held a public forum during Earth Week and gave an update on recycling and landfill projects.
- Continue to work with Solid Waste Management Advisory Committee.
- Held two Household Hazardous Waste Roundup days at the Yellowknife Community Arena parking lot in May and September.
- Now accept a larger variety of hazardous waste, and working with local contractor on proper disposal.
- Tipping fees were increased on January 1.
- Implemented recommendations from the Landfill Fire Risk Reduction Plan.
- First batch of finished compost was produced and will be ready in spring of 2012.
- Collecting organic material from businesses as part of the composting pilot project.
- Partnered with NorthwesTel to divert almost 6,000 telephone books from the landfill for recycling.
- Established a three-cell salvage area and recycling loop at the landfill.
- Crushed and shipped south approximately 185 scrap vehicles to be recycled.
- Sorted the scrap steel area. Baled light tin and shipped heavy steel to be recycled.
- E-waste shelter constructed in the fall.
- Mulch was made available for citizens as well as City projects.
- Paint area being cleaned up.
- Tire pile being dealt with through our recycler.
- New landfill cell built and prepared for solid waste.
- Wood waste area being ground up and future use being looked at.
- New roll-off truck on order.

### 2012/2013/2014 Goals

- Efficiently and effectively collect, handle, and dispose of solid waste.
- Continue to improve the City's recycling program by issuing the City Commitment for Public Education and improve the recycling page on the City website.
- Continue to work with other municipalities and levels of government on recycling initiatives.

### 2012/2013/2014 Objectives

- Provide garbage collection through a private contractor to residential areas once per week. Multi-family units and commercial premises will be serviced by a private contractor.
- Continue to implement goals and objectives laid out in the Community Waste Management Strategic Plan adopted by Council in August 2001 and revised in 2006.
- Implement recommendations as laid out in the External Review of the Solid Waste Facility Operations and Processes, adopted for information by Council in August 2006.
- Reduce solid waste landfill volumes by both baling waste and operating feasible waste diversion programs.
- Increase public awareness, education, and participation in waste diversion through annual publications, weekly flyer inserts, and public forums.
- Carry out the orderly closure of the existing landfill site.
- Begin preparations for the move to a new landfill site.

## SOLID WASTE MANAGEMENT FUND

### Solid Waste Management Fund Budget

	2010 Actual (\$000's)	2011 Budget (\$000's)	2011 Forecast (\$000's)	2012 Budget Recommended (\$000's)	2013 Budget (\$000's)	2014 Budget (\$000's)	Note
<b>Revenue</b>							
User Charges							
Solid Waste Levy	508	554	553	667	760	792	(1)
Tipping Fees	1,345	1,263	1,637	1,548	1,711	1,786	(1)
Sales of Recyclables	119	35	60	100	100	100	
	1,971	1,852	2,250	2,314	2,571	2,678	
Allocated to Capital	(214)	(181)	(181)	(260)	(260)	(260)	
	1,757	1,671	2,069	2,054	2,311	2,418	
<b>Expenditures (By Activity)</b>							
Waste Collection	275	282	312	326	337	348	
Waste Processing	1,221	975	1,168	1,067	1,111	1,154	
Waste Recycling	493	192	379	450	454	458	
Site Restoration/Closure							
-Annual Accrual	85	-	-	-	-	-	(2)
-Actual Cost of Landfill Closure	87	254	254	265	255	245	
-Reduction In Closure Liability	(87)	(254)	(254)	(265)	(255)	(245)	
Amortization	157	218	218	241	241	241	
	2,231	1,667	2,077	2,083	2,142	2,200	
<b>Net Revenue (Expenditures)</b>	(474)	4	(8)	(29)	169	218	
<b>Interfund Transfers</b>							
(To) From General Fund	(205)	(182)	(219)	(221)	(246)	(257)	(3)
Change in Fund Balance Before Reallocation of Amortization	(679)	(177)	(227)	(250)	(78)	(39)	
Reallocation of Amortization	157	218	218	241	241	241	
<b>Change in Fund Balance</b>	(522)	41	(9)	(9)	163	201	
<b>Opening Balance</b>	182	63	(340)	(349)	(358)	(195)	
<b>Closing Balance</b>	(340)	104	(349)	(358)	(195)	6	
<b>Expenditures (By Object)</b>							
Wages & Benefits	691	745	724	805	847	886	
Other O&M	1,540	922	1,352	1,038	1,054	1,073	
	2,231	1,667	2,077	2,083	2,142	2,200	

#### Notes:

(1) Revenues are based on the assumption that the user fee rates will increase as follows:

Starting in 2012

- Single-family unit solid waste monthly levy increases from \$12 to \$14.5 in 2012, \$16.5 in 2013 and Municipal Price Index (MPI) increase from 2014 onwards
- Tipping fees increase by 10% each year for 2012 and 2013 and MPI increase from 2014 onwards

(2) In 2000 and thereafter, under Generally Accepted Accounting Principles, the City accrues the liability for landfill closure and restoration. There is an estimated difference of \$750,000 between the net present value of future landfill liabilities and the actual costs that will be incurred. City will continue to accrue the difference over the next four years. In 2012, 2013 and 2014 the City plans to set aside Capital Fund of \$150,000, \$150,000 and \$150,000 respectively for site restoration.

(3) The administration fee charged by the General Fund is 10% of revenue as per current policy.



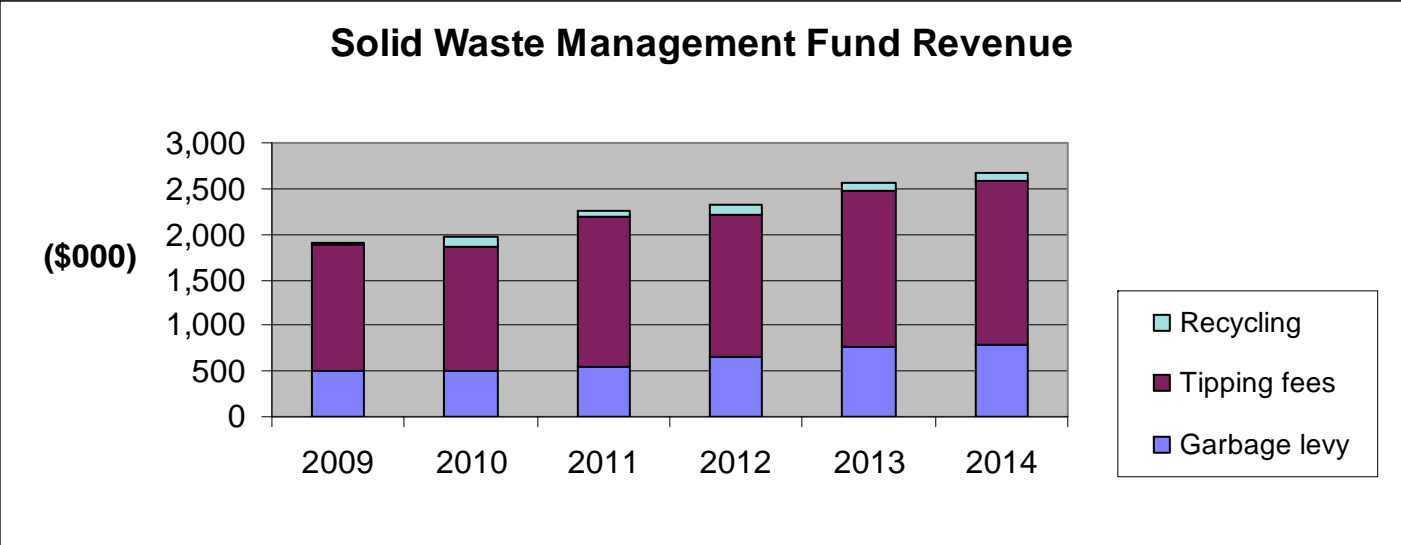

## SOLID WASTE MANAGEMENT FUND

Solid Waste Performance Measures	Projected 2010	Actual 2010	Projected 2011	Forecasted 2012	Forecasted 2013	Forecasted 2014	Notes
<b>Workload Indicators</b>							
Material diverted from waste stream (bales)							
White goods	190	207	0	200	200	200	
Newsprint/cardboard/paper	1,250	892	1,500	1,300	1,300	1,300	(1)
Steel/tin cans	10	10	10	10	10	10	
Car batteries	40	28	40	40	40	40	(2)
High density polyethylene (All Plastics)	50	61	60	65	65	65	
Tires (bales)	150	0	0	150	150	150	
Boxboard	135	176	180	140	140	140	(3)
Recycled Total	1,825	1,374	1,790	1,905	1,905	1,905	
No. of bales per annum	9,900	10,100	9,900	9,900	9,900	9,900	(6) & (7)
Additional recycling							
Litres of waste oil collected	18,000	18,000	21,000	18,000	18,000	18,000	(5)
Vehicles shipped out	-	164	200	150	150	150	
<b>Efficiency Measures</b>							
Waste collection cost per capita	\$14.46	\$13.80	\$15.45	\$15.97	\$16.31	\$16.66	(4)
<b>Effectiveness Measures</b>							
% of materials recycled/diverted (excluding vehicles)	15.6%	12.3%	13.3%	14.3%	15.0%	16.0%	(6), (7) & (8)

**Notes:**

- (1) Corrugated cardboard is the highest commodity per volume that we ship south to be recycled
- (2) Commercial customers are now responsible for recycling their own waste batteries. Residents are still permitted to drop off three car batteries per month at the Solid Waste Facility.
- (3) Boxboard was added to the recycling program in the spring of 2006 and had the largest increase.
- (4) According to the 2005 Citizen Survey, 57% of people would be willing to pay a fee for curbside recycling. According to the 2006 Citizen Survey, 52% of people would be willing to pay \$6 per month for curbside recycling. In 2007, 73% of residents were satisfied with the City's recycling depots. In 2010, 55% of citizens would be willing to purchase compost from a centralized compost facility at a cost of \$5 or less for a five-gallon pail.
- (5) 44,000 litres of waste oil was shipped south in 2008 to be recycled. This is done approximately every 4 years.
- (6) Amount of waste received decreased with implementation of User Pay System on January 1, 2006. Some stores like WalMart and Canadian Tire started recycling cardboard and shipping it south.
- (7) If implemented, a proposed landfill ban on cardboard will significantly increase the amount of recycling we receive.
- (8) The percentage of waste diversion has increased from 2.8% in 2004. Reducing the bag limit from 3 to 2 bags per week will increase recycling.
- (9) According to the 2007 Citizen Survey, 63% of residents visited the Solid Waste Facility and 78% of citizens were satisfied with garbage collection service. In the 2008 survey, 49% of citizens would be willing to pay a one-time \$25 fee to the City for a backyard composter. In 2010, 49% of citizens support the City decreasing residents' current weekly garbage limit from three bags to two.



## WATER & SEWER FUND

---

### WATER & SEWER FUND

#### Overview

This fund's activities include all aspects of establishing, operating and maintaining buildings, equipment and work related to the supply and treatment of potable water, distribution of potable water, and collection, treatment and disposal of sewage. These costs are recovered through charges to service users.

#### 2011 Highlights

The Water and Sewer fund highlights for 2011 include:

- Provided engineering for the replacement of water and sewer mains and water and sewer services on Knutsen Avenue and a section of Bromley Drive. The total budget was \$2.8 million.
- Annual/quarterly submissions of the City's water and sewage treatment report to the Mackenzie Valley Land and Water Board.
- Yearly pumphouse and liftstation preventative maintenance as time permitted.
- Yearly cleaning of boilers at Pumphouse #1.
- Water & Sewer staff cleaned, serviced, and repaired all boilers and furnaces in City system.
- Yearly preventative maintenance of fire extinguishers on City premises.
- Monthly fly-out testing of lagoon at F1 and F3 sampling sites as per regulatory requirements. Three bulk samples taken for toxicity testing. Weekly samples after July 1 overflow.
- Pumphouse and liftstation fire alarms were serviced in May 2011.
- Continue to add Actizyme treatment to the sewage system.
- Thawed storm drains and culverts during spring runoff.
- Upgraded fire hydrants as required. Painted one-third of hydrants in City system.
- Leak detection program ongoing. Found and repaired 67 leaks to date - expect a total of 90 for 2011. This is attributed mainly to extended power outages during the winter months.
- Flushed City's fire hydrants and water main system and completed flow testing on all hydrants.
- Continued sewer flushing program. Expect to complete 80% of City mains in 2011.

- Liftstation cleaning to take place beginning October 2011.
- Valve exercising program with fire hydrant flushing, and repairs completed as required.
- Weekly chlorine monitoring in water system.
- Daily chlorine monitoring in all pumphouses.
- Water system temperature monitoring during winter months.
- Annual lagoon decant began September 6 for approximately eight weeks.
- City entered into a contract with NORTEC Industries to perform maintenance and repairs to our SCADA and programming systems.
- Pumphouse and liftstation crew facilitated and organized the servicing by NORTEC of all City generators and transfer switches .
- A number of training courses such as confined space, chlorination, water treatment, and waste water collections were provided to Water & Sewer staff.
- Maintenance schedules have been improved and implemented for water and sewer facilities, increasing the maintenance that can be performed by City staff.
- All water and sewer facilities have been clearly labeled, per water licence requirements.
- Confined space procedures have been upgraded, and labeling of such areas completed.

#### Pumphouse #1

- A new UPS system has been ordered and will be installed in late fall to provide increased back-up for communication and emergency telephone systems.\*
- Radio system upgrade completed.
- Ongoing SCADA maintenance.
- Pump #2 has failed and is on order for replacement.

\* Pumphouse operators do double duty as both pumphouse operators and emergency dispatchers, which is unique to Yellowknife.

#### Pumphouse #2

- Pump wells were cleaned and intake screens replaced.

#### Pumphouse #3

## WATER & SEWER FUND

---

- New access ladders were installed in both reservoir cells.
- Pumps have been removed and inspected under improved maintenance program.

### Pumphouse #4

- Pump #6 has been ordered and received and waiting on a seal for installation.
- Truck fill pump upgrades in progress.
- Upgrades completed to chlorine room to improve employee safety.

### Pumphouse #5

- Routine maintenance.

### Pumphouse #6

- Bypass piping completed by Water & Sewer staff to improve facility and area function.

### Liftstation #1

- Annual pump and communitor maintenance.

### Liftstation #2

- Annual pump maintenance.

### Liftstation #3

- Annual pump maintenance.

### Liftstation #4

- Annual pump and communitor maintenance.
- Roofing and ceiling insulation upgrade completed.
- Back-up generator has been spec'd and ordered.

### Liftstation #5

- New communitor ordered in January, not received.
- Pumps removed, inspected and repaired to ensure maximum performance.
- Existing diesel pump has been removed and replacement electric motor and pump have been ordered for #3 position to improve building function.

### Liftstation #6

- Annual pump maintenance.

### Liftstation #7

- Annual pump and communitor maintenance.
- Contractor to complete roofing upgrade.

### Liftstation #8

- Annual pump maintenance.
- New fence installed to adjacent neighbour on Rivett Crescent and drainage improved.

### Liftstation #9

- Annual pump maintenance.

### Liftstation #10

- Annual pump maintenance.

### Liftstation #11

- Annual pump maintenance.
- Piles installed to secure building foundation.
- Area drainage improved and new decking on building completed.

### Reservoir #1

- All cells cleaned and inspected.

## 2012/2013/2014 Goals

The goals of the Water & Sewer Fund are to:

- Provide a reliable supply of high quality, potable water to Yellowknife citizens, and efficiently and responsibly dispose of waste water.
- Expand on and maintain a ten-year capital replacement plan for potable water and waste water systems. Maintain piped water and sewer systems in good, functional condition.
- Continue elimination of water losses and waste on mains and services.
- Continue upgrading the City's water and sewer systems and maintain a good, workable standard.
- Conduct regular upgrading of supervisory staff (e.g. courses and



## WATER & SEWER FUND

---

conferences to learn of new technology and explore how it could benefit the City).

- Continue to upgrade safety training of all staff.
- Continue to upgrade safety equipment and procedures for staff.
- Increase monitoring of water temperature in the critical areas of the piped water distribution system which will reduce heating water and will result in additional fuel and power savings. The water obtained from the Yellowknife River is typically around 1°C during the winter.
- Rebuild or replace pumphouse and liftstation pumps to increase pumping capacity and reduce power consumption in a cost-effective manner.
- Hire qualified people to maintain a high standard of repair and maintenance.
- Increase water quality monitoring with the installation of continuous chlorine monitors throughout the system.

### 2012/2013/2014 Objectives

The objectives of the Water & Sewer Fund are to:

- Provide the community with potable water that meets or exceeds the Canadian Drinking Water Quality Guidelines, our water licence requirements, territorial and federal environmental and public health regulations as established by the Mackenzie Valley Land and Water Board and the *Public Health Act*.
- Treat and dispose of waste water in order to meet or exceed the requirements of the *NWT Water Act* and our water licence discharge and monitoring requirements.
- Provide adequate water pressure and volume to meet all fire suppression needs and plan for remedial measures of future capital projects should deficiencies be found.
- Maintain water quality and protect public health through timely water quality testing – daily chlorine and fluoride, weekly bacterial and general water quality analysis.
- Repair or replace piped water and sewer distribution mains prior to ultimate failure or excessive maintenance.
- Manage and monitor trucked water delivery and trucked sewage pump-out contracts.
- Eliminate water main and service losses through annual leak detection and repair, elimination of bleeders and calibration or replacement of water meters over the next three years.

- Continue to reduce the number of single line water services and services having bleeders, heat trace and Aquaflo units, as resources permit.
- Review with Engineering Division future capital projects to prioritize spending to best suit short- and long-term requirements from an operation and maintenance standpoint.
- Initiate changes to reduce staff time spent on water meter reading and billing through technologically advanced reading and downloading equipment, as well as a comprehensive review of current practices.
- Establish an information inventory for the City's underground infrastructure and utilities.
- Submit to the Mackenzie Valley Land and Water Board waste reports required by City's new water licence.
- Public Works and Engineering and the Water & Sewer Division continue to work together for capital replacement projects.
- Review by-laws to ensure residents are being serviced to the highest standard, equally and fairly.



## WATER & SEWER FUND

### Water & Sewer Fund Budget

	2010 Actual (\$000's)	2011 Budget (\$000's)	2011 Forecast (\$000's)	2012 Budget Recommended (\$000's)	2013 Budget (\$000's)	2014 Budget (\$000's)	Note
<b>Revenue</b>							
User Charges							
Piped Water	5,974	5,974	6,122	6,204	6,407	6,617	(1)
Trucked Water	1,007	1,009	1,000	1,043	1,079	1,116	(1)
Other User Charges	121	134	138	156	159	161	(2)
	7,103	7,117	7,260	7,403	7,645	7,895	
Allocated to Capital	(1,246)	(1,255)	(1,298)	(1,341)	(1,414)	(1,488)	(3)
	5,858	5,862	5,962	6,062	6,232	6,406	
<b>Expenditures (By Activity)</b>							
Sewage Disposal	1,475	1,471	1,522	1,557	1,594	1,639	
Water Distribution	2,978	3,051	3,076	3,094	3,181	3,284	
	4,453	4,522	4,597	4,650	4,775	4,922	
Labour & Equipment Allocation	294	269	275	270	278	285	
Amortization	3,827	4,244	4,244	3,886	3,910	3,926	
	8,574	9,034	9,116	8,807	8,963	9,133	
<b>Net Revenue (Expenditures)</b>	(2,716)	(3,173)	(3,155)	(2,744)	(2,732)	(2,727)	
<b>Interfund Transfers</b>							
(To) From General Fund	(1,063)	(1,068)	(1,089)	(1,111)	(1,147)	(1,184)	(4)
Change in Fund Balance Before Reallocation of Amortization	(3,779)	(4,240)	(4,244)	(3,855)	(3,878)	(3,911)	
Reallocation of Amortization	3,827	4,244	4,244	3,886	3,910	3,926	
<b>Change in Fund Balance</b>	48	4	0	31	32	15	
<b>Opening Balance</b>	36	91	84	84	116	147	
<b>Closing Balance</b>	84	95	84	116	147	162	
<b>Expenditures (By Object)</b>							
Wages & Benefits	2,012	2,066	2,041	2,104	2,164	2,220	
Other O&M	6,561	6,969	7,076	6,702	6,799	6,913	
	8,574	9,034	9,116	8,807	8,963	9,133	

#### Notes:

- (1) Piped and Trucked Water - See the following schedule of water and sewer rates based on the rate increases of 3% each year from 2012 to 2014 for the estimated consumption and revenue. New utility account set-up fee of \$30 each starting in 2012.
- (2) Other user charges are mainly from utilities penalties.
- (3) According to Budget Policies, allocation to Capital Fund is based on 30% of revenues to fund water and sewer infrastructure projects. The actual transfer (plus the previous increase in infrastructure replacement levy) is reduced by \$200,000 from 2012 to 2014.
- (4) The Water and Sewer Fund pays an administration fee of 15% of revenues to the General Fund.



# WATER & SEWER FUND

<b>Piped Services:</b>		<u>Monthly Charge (\$)</u>	<u>Average Monthly # of Accts.</u>	<b>2012 Budgeted Revenue (\$)</b>
Equivalent residential unit charge		6.79	10,942	891,252
Demand charge based on water meter size:				
	5/8"	8.43	4,320	436,773
	3/4"	12.64	1	152
	1"	21.07	60	15,173
	1 1/2"	46.35	46	25,585
	2"	80.06	72	69,173
	3"	176.96	15	31,854
	4"	311.81	4	14,967
	6"	716.30	1	8,596
Consumption:				
	336,000,000 gallons			
	14.01/1,000 gallons			<u>4,710,149</u>
				<u>6,203,673</u>
Others				
Water Meters Fee @ \$119				
Connect/ Disconnect Permit @\$36				

<b>Trucked Services</b>	<u>Rate</u>	<u>Annual # of Account/ Consumption (gallons)</u>	<b>2012 Budgeted Revenue (\$)</b>
Residential access charge - accounts	\$49.06	5,263	258,197
Residential consumption <3,300 gallons	\$14.01	9,700,000	135,878
Residential consumption >3,300 gallons	\$79.92	400,000	31,967
Commercial access charge - accounts	\$140.07	3,157	442,200
Commercial consumption <3,300 gallons	\$14.01	7,600,000	106,461
Commercial consumption >3,300 gallons	\$79.92	600,000	47,951
			<u>1,022,653</u>
Others			
Bulk Sales @ \$18.15/ 1,000 gallon			20,600
New Utility Account Set-up/Registration Fee	\$30	833	25,000

### Infrastructure Replacement Levy (to finance Water & Sewer Projects)

Charge is Per Equivalent Residential Unit (ERU)

	<u>Monthly Charge (\$)</u>	<u>Average Monthly # of ERU</u>	<b>2012 Budgeted Revenue (\$)</b>
	10.00	11,629	1,395,480

## WATER & SEWER FUND

### Sewage Disposal

	2010 Actual (\$000's)	2011 Budget (\$000's)	2011 Forecast (\$000's)	2012 Budget Recommended (\$000's)	2013 Budget (\$000's)	2014 Budget (\$000's)
<b>Liftstations/Effluent Operations</b>						
Operations & Maintenance	300	341	338	358	363	372
Allocated Equipment	19	17	29	26	27	28
Allocated Labour	142	134	144	149	153	157
	<b>461</b>	<b>492</b>	<b>511</b>	<b>533</b>	<b>543</b>	<b>557</b>
<b>Trucked Sewage</b>						
Contracted Services	695	716	696	737	758	781
Allocated Equipment	0	1	1	1	1	1
Allocated Labour	8	9	8	9	9	9
	<b>703</b>	<b>726</b>	<b>705</b>	<b>746</b>	<b>767</b>	<b>791</b>
<b>Sewage System Maintenance</b>						
Operations & Maintenance	140	86	117	88	90	92
Allocated Equipment	32	27	49	44	45	47
Allocated Labour	138	139	140	145	149	153
	<b>310</b>	<b>253</b>	<b>306</b>	<b>277</b>	<b>284</b>	<b>291</b>
<b>Total Sewage Disposal</b>						
Direct Costs	1,134	1,143	1,150	1,184	1,211	1,245
Allocated Equipment	52	45	78	71	73	75
Allocated Labour	289	283	293	302	311	319
	<b>1,475</b>	<b>1,471</b>	<b>1,522</b>	<b>1,557</b>	<b>1,594</b>	<b>1,639</b>



**WATER & SEWER FUND**

**Water Distribution**

	2010 Actual (\$000's)	2011 Budget (\$000's)	2011 Forecast (\$000's)	2012 Budget Recommended (\$000's)	2013 Budget (\$000's)	2014 Budget (\$000's)
<b>Pumphouses</b>						
Labour - Pumphouse # 1	-	-	-	-	-	-
Operations & Maintenance	865	923	1,004	958	972	1,001
	865	923	1,004	958	972	1,001
Allocated Equipment	4	5	6	5	5	5
Allocated Labour	874	905	886	914	940	964
	1,743	1,833	1,896	1,877	1,918	1,971
<b>Trucked Water Delivery</b>						
Contracted Services	714	687	621	666	699	734
<b>Water Line/Hydrant Maintenance</b>						
Operations & Maintenance	72	71	89	73	74	76
Allocated Equipment	24	28	37	33	34	35
Allocated Labour	329	309	334	344	354	363
	425	408	460	450	462	474
<b>Water Meter Services</b>						
Operations & Maintenance	13	11	13	11	11	12
Allocated Equipment	5	7	8	7	7	7
Allocated Labour	78	103	79	82	84	86
	96	122	99	100	102	105
<b>Total Water Distribution</b>						
Direct Costs	1,664	1,692	1,727	1,708	1,757	1,823
Allocated Equipment	33	41	50	45	46	48
Allocated Labour	1,281	1,318	1,299	1,340	1,378	1,413
	2,978	3,051	3,076	3,094	3,181	3,284

## WATER & SEWER FUND

Water & Sewer Fund Performance Measures	Projected 2010	Actual 2010	Projected 2011	Forecasted 2012	Forecasted 2013	Forecasted 2014	Notes
<b>Workload Indicators</b>							
No. of metres of replaced water and sewer mains	276	276	346	826	826	826	(1)
No. of metres of new water and sewer mains	0	0	0	0	0	0	
No. of fire hydrants	315	315	315	315	315	315	(2)
No. of fire hydrants flushed	315	315	315	315	315	315	
No. of bleeders on City main lines	4	4	4	1	1	1	(3)
No. of water meters replaced							
Public Works (in-house)	20	20	20	40	40	40	
Contracted out	25	25	0	0	0	0	
Total water meters replaced	45	45	20	40	40	40	(4)
No. of new water and sewer (W&S) services privately installed:							
Niven Lake	5	5	5	5	5	5	
Other	2	2	2	2	2	2	
No. of services replaced under Capital	5	5	30	30	30	30	
No. of services repaired/replaced under Service Connection Failure Assistance Fund (SCFA)							
Public Works (in-house)	60	60	80	50	50	50	
Contracted out	5	5	10	5	5	5	
Total	65	65	90	55	55	55	
No. of services repaired/replaced by City (Capital and O&M)	70	70	120	85	85	85	
No. of single line bleeders eliminated	0	0	0	15	15	15	
No. of Aquaflo units eliminated	0	0	3	5	5	5	

**Notes:**

- (1) In 2010, it was carried out on Woolgar Avenue. In 2011 it was on Knutsen Avenue.
- (2) Fire hydrants - In addition there are 9 fire hydrants at the airport and 10 in Northlands Trailer Park. Northlands hydrants are flushed by City staff.
- (3) Bleeders on City mains in Niven Lake are required until circulation loops are tied in and Pumphouse #6 (Niven Booster Station) can operate as designed.
- (4) Replacement of meters will be ongoing, especially now that specifications have been changed due to purchase of automated reading equipment by Financial Services Division.



## LAND DEVELOPMENT FUND

---

### LAND DEVELOPMENT FUND

This Fund's activities include all aspects of acquiring, developing, and disposing of municipal lands including the following:

- Preparation of conceptual development plans and comprehensive plans for development areas;
- Property appraisal, legal survey and mapping work related to lands for disposal, as well as engineering and constructing infrastructure required in the development area;
- Recovery, through the sale of public lands, of all direct, indirect, and associated costs related to municipal lands in accordance with the Land Administration By-law.

Utility infrastructure installed on public rights-of-way in new subdivisions/development areas will become the responsibility of the Water and Sewer Fund upon final acceptance by the City. Until that time, it is the responsibility of the Land Development Fund.

### 2011 Highlights

The highlights of the Land Development Fund include:

- Sale of Niven Lake Phase VII multi-family parcel to Mission Ventures and 15 single family lots;
- Completion of lot registration and marketing for final stage of Niven Lake Phase VII;
- Completion of lot layout of Enterprise Drive extension in Kam Lake;
- Sale of one lot in Engle Business District;
- Development of a land assembly strategy for the downtown core which focuses on the revitalization of 50th Street; and
- Incorporation of a development phasing strategy into the General Plan to guide growth and infrastructure investment over the next five years.

### 2012/2013/2014 Goals

The goals of the Land Development Fund are to:

- Promote development and redevelopment opportunities in the City;
- Assemble strategic parcels of land for future residential, commercial, industrial, institutional, and recreational development; and
- Ensure that an ongoing supply of developable land is available and priced in accordance with the market.

### 2012/2013/2014 Objectives

The objectives of the Land Development Fund are to:

- Complete the development scheme and zoning amendment for Engle Business District Phases II and III;
- Complete the zoning, develop a marketing plan, and host a ballot draw for the lots identified in the Enterprise Drive extension;
- Work with YKDFN, MACA, and Aboriginal Affairs and Northern Development Canada to expedite the land claims and land selections which are compatible with the City's long-term growth strategy;
- Create development schemes for those lands prioritized for residential development in the new General Plan;
- Continue with a core area land assembly strategy based on redevelopment, economic revitalization, and community integration of key parcels within the Old Town/Waterfront Area, downtown, and Old Airport Road; and
- Submit further land applications to MACA to facilitate future growth and accommodate future development demand.

# LAND DEVELOPMENT FUND

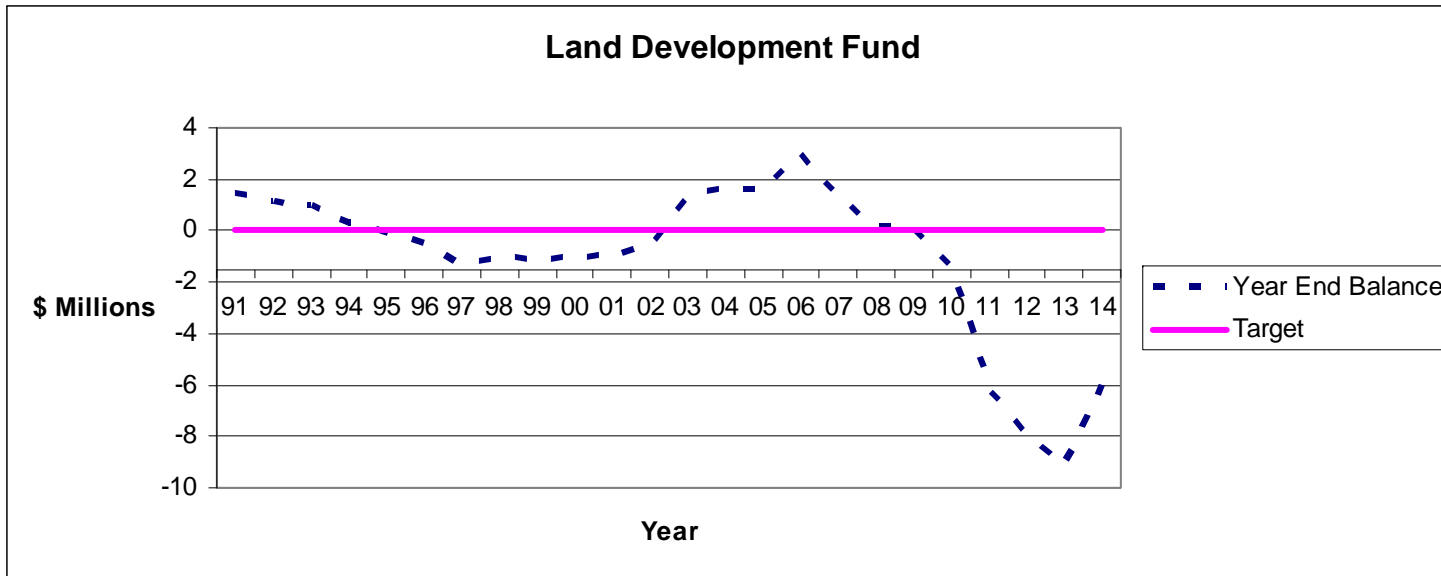

**LAND DEVELOPMENT FUND**

	2010 Actual (\$000's)	2011 Budget (\$000's)	2011 Forecast (\$000's)	2012 Budget Recommended (\$000's)	2013 Budget (\$000's)	2014 Budget (\$000's)	Note
<b>Revenue</b>							
Government Transfers	3,613	-	-	-	-	-	(1)
User Charges							
Land Leases	114	104	104	115	115	115	
Land Sales	4,071	2,728	2,365	3,806	3,267	3,430	(2)
	<u>7,798</u>	<u>2,832</u>	<u>2,469</u>	<u>3,921</u>	<u>3,382</u>	<u>3,545</u>	
<b>Expenditures (By Activity)</b>							
Land	9,071	1,623	6,979	5,514	4,496	184	(3)
	<u>9,071</u>	<u>1,623</u>	<u>6,979</u>	<u>5,514</u>	<u>4,496</u>	<u>184</u>	
<b>Net Revenue (Expenditures)</b>	<u>(1,273)</u>	<u>1,209</u>	<u>(4,510)</u>	<u>(1,593)</u>	<u>(1,114)</u>	<u>3,361</u>	
<b>Interfund Transfers</b>							
(To) From General Fund	(175)	(175)	(175)	(175)	(175)	(175)	(4)
(To) Downtown Development Reserve	-	-	(39)	-	-	-	
(To) From Capital Fund	-	(70)	(58)	-	-	-	
<b>Change in Fund Balance</b>	<u>(1,448)</u>	<u>964</u>	<u>(4,782)</u>	<u>(1,768)</u>	<u>(1,289)</u>	<u>3,186</u>	
<b>Opening Balance</b>	<u>106</u>	<u>1,389</u>	<u>(1,342)</u>	<u>(6,124)</u>	<u>(7,892)</u>	<u>(9,181)</u>	
<b>Closing Balance</b>	<u>(1,342)</u>	<u>2,353</u>	<u>(6,124)</u>	<u>(7,892)</u>	<u>(9,181)</u>	<u>(5,995)</u>	

**Notes:**

- (1) This is the GNWT's contribution for the Kam Lake Bypass Road.
- (2) Land sales for 2012 to 2014 are based on selling parcels of Niven Lake Phase 7, Engle Business District and Enterprise Drive Extension over next three years
- (3) When land from land inventory is resold, the value of the land is shown as an expenditure. The land inventory is valued at market value, so the land sales revenue and expenditure usually offset each other.
- (4) According to Budget Policies, a minimum of \$100,000 will be transferred from Land to General Funds if the fund has achieved the minimum balance set out in the Stabilization Policy and the minimum balance is no less than nil.



THIS PAGE LEFT BLANK INTENTIONALLY



## SERVICE CONNECTION FAILURE ASSISTANCE FUND

---

### SERVICE CONNECTION FAILURE ASSISTANCE FUND

#### Overview

The Service Connection Failure Assistance Fund (SCFA) was set up as a type of insurance coverage for residents who have a problem with their water and sewer service.

Water and sewer service connection failures are generally due to freezing water lines. The cost of carrying out emergency repairs under winter conditions can exceed \$10,000. The SCFA applies also to failure of sewer service connections. A failure of a sewer system requires work to correct the situation.

Council established the SCFA to provide municipal service customers with low-cost insurance to cover repair costs.

The majority of customers participate in the program which, in the event of a failure, covers repair costs above \$500 and up to a maximum of \$25,000. The property owner pays the first \$500 (the deductible) and all costs exceeding \$25,000. The premium, currently set at \$5.00 per equivalent residential unit per month, is collected via a levy on the City water bill.

The program applies to failure of water or sewer services that occur between the building foundation and the City main. To qualify for the program a customer must have:

- Properly installed, operated and maintained freeze protection system; and
- Water and sewer service connections in accordance with the applicable by-laws and codes.

The costs that are covered under the program are those associated with the excavation, water and sewer repair or replacement, backfilling, placement of topsoil on the customer's property, pavement and sidewalk repair on City roadways.

#### Standard Water and Sewer Service Connection

In 1984 the City adopted the two-line circulation system as its standard water service connection that proved to be the most cost-effective freeze protection system available. The system consists of two insulated copper lines connected by a small pump located in a heated area inside the premises, which continually circulates water back to the City main to prevent freezing. Some downtown blocks also utilize a two-line water system, but with an orifice system rather than a circulating pump. The orifice system works on pressure differential of supply and return lines.

Prior to 1984 a variety of freeze protection systems were being installed. These were typically single lines with either bleeders, heat tape, or the Aquaflow system to provide freeze protection.

The problems with the freeze protection systems associated with single-line services are:

- Bleeders waste a huge volume of treated water and add to the volume of sewage that must be pumped to the sewage lagoon.
- Heat tape has a relatively short life span and leads to frequent freeze-up problems.
- The Aquaflow system is noisy and, as the system pumps water into the City's potable water system it is not tamper-proof.

As the City continues to reconstruct streets and services in older sections, service connections are upgraded to the current standard. Water and sewer service connections that are repaired under the SCFA are upgraded to the current standard as well.

#### 2011 Highlights

The Service Connection Failure Assistance Program (SCFA) highlights for 2011 include the:

- Repair of 90 services by Public Works & Engineering staff. Expected 63 done to date. Nine of these required complete upgrades due to sewer failure that required immediate attention.

## SERVICE CONNECTION FAILURE ASSISTANCE FUND

---

### 2012/2013/2014 Goals

The goals of the Service Connection Failure Assistance Program (SCFA) include:

- Continue to be responsive to the residents of Yellowknife by minimizing the amount of time that they are without essential services.
- Provide a reliable supply of high quality, potable water to Yellowknife citizens, and efficiently and responsibly dispose of wastewater, as mandated under the *Cities, Towns and Villages Act*.
- Maintain piped water and sewer systems in good functional condition.
- Continue elimination of water losses and wastage on mains and services.
- Carry on upgrading the City water and sewer systems.
- Hire qualified people to maintain a high standard of repair and maintenance of all assets of the City.
- Conduct regular upgrading of supervisory staff through courses and conferences to learn about new technologies and explore how they might benefit the City.

### 2012/2013/2014 Objectives

The objectives of the Service Connection Failure Assistance Program (SCFA) include:

- Continue to reduce the number of single-line water services and services having bleeders, heat trace and Aquaflow units, as resources permit.
- Provide the community with potable water that meets or exceeds the Canadian Drinking Water Quality Guidelines, our water licence requirements, territorial and federal environmental and public health regulations as established by the Mackenzie Valley Land and Water Board and the *Public Health Act*.
- Eliminate water main and service losses through annual leak detection and repair, and eliminate bleeders.



## SERVICE CONNECTION FAILURE ASSISTANCE FUND

### Service Connection Failure Assistance Fund

Service Connection Failure Assistance Fund provides for the repair and maintenance of the water supply and sewage lines from the City mains to the customer's building, and provides assistance to customers.

	2010 Actual (\$000's)	2011 Budget (\$000's)	2011 Forecast (\$000's)	2012 Budget Recommended (\$000's)	2013 Budget (\$000's)	2014 Budget (\$000's)	Note
<b>Revenue</b>							
Insurance Premium	569	571	571	798	1,142	1,143	(1)
Insurance deductible	27	3	30	70	70	70	(2)
	<u>596</u>	<u>574</u>	<u>601</u>	<u>868</u>	<u>1,212</u>	<u>1,213</u>	
<b>Expenditures</b>							
Contracted Services	236	255	261	544	880	874	
Materials	52	54	75	54	54	55	
Labour/ Equipment	308	265	265	270	277	284	(3)
	<u>596</u>	<u>574</u>	<u>601</u>	<u>868</u>	<u>1,212</u>	<u>1,213</u>	
<b>Net Revenue (Expenditures)</b>	-	-	-	-	-	-	
<b>Interfund Transfers</b>							
(To) From Capital Fund	-	-	-	-	-	-	
<b>Change in Fund Balance</b>	-	-	-	-	-	-	
<b>Opening Balance</b>	-	7	-	-	-	-	
<b>Closing Balance</b>	-	7	-	-	-	-	

#### Notes:

- (1) See the following schedule of the Service Connection Failure Assistance Program premiums and deductibles.  
In order to clear the backlog of \$1 million in repairs, the premium will increase from \$5 to \$7 in 2012 and \$10 in 2013.
- (2) The deductible will increase from \$500 to \$1,000 starting in 2012.
- (3) Labour and equipment are the internal charges from the Water and Sewer Fund.

<b>Service Connection Failure Assistance</b>	<b>Rate</b>	<b>Number/ Volume</b>	<b>2012 Budgeted \$</b>
Budgeted revenue is based on the following:			
Premiums Per Equivalent Residential Unit	\$7.00	9,501	798,084
Deductible-(Average # of Monthly Charges)	\$1,000.00	5.83	70,000
Total Revenue			<u>868,084</u>

## SERVICE CONNECTION FAILURE ASSISTANCE FUND

---

### Service Connection Failure Assistance Performance Measures

	Projected 2010	Actual 2010	Projected 2011	Forecasted 2012	Forecasted 2013	Forecasted 2014
<b>Workload Indicators</b>						
No. of services repaired/replaced under SCFAF:						
Public Works (in-house)	50	54	80	50	50	50
Contracted Out	5	0	10	15	25	25
Total	65	54	90	60	75	75
<b>Effectiveness Measures</b>						
Average cost to repair/replace service with dual circulating water service under SCFAF	\$6,800	\$6,800	\$7,000	\$7,000	\$7,000	\$7,000



## CAPITAL FUND

### Capital Fund Summary

	2010 Budget (\$000's)	2010 Actual (\$000's)	2011 Budget (\$000's)	2011 Forecast (\$000's)	2012 Budget (\$000's)	2013 Budget (\$000's)	2014 Budget (\$000's)	Note
<b>Revenue</b>								
Taxation	1,088	1,084	1,436	1,299	1,452	1,452	1,452	
Government Transfers								
Formula Funding	6,755	6,753	6,753	6,753	6,753	6,753	6,753	
Other Grants	8,088	4,551	6,809	8,707	6,809	6,809	6,809	
User Charges	2,876	3,157	3,371	3,574	3,498	3,132	3,164	
	<b>18,807</b>	<b>15,545</b>	<b>18,369</b>	<b>20,333</b>	<b>18,512</b>	<b>18,146</b>	<b>18,178</b>	
<b>Expenditures</b>								
Fleet Management	1,254	872	1,259	1,206	1,449	1,005	1,067	
General Government	877	630	1,071	2,598	810	380	290	
Community Services	12,567	8,573	1,708	1,829	1,492	1,391	1,157	
Public Safety	168	254	1,242	1,400	190	210	205	
Planning & Development	500	343	950	2,085	1,000	1,100	1,500	
Public Works	2,118	2,086	4,207	3,484	1,128	2,845	3,687	
Solid Waste Management	2,224	1,218	905	2,737	905	925	300	
Community Energy Plan (CEP)	500	866	500	976	500	500	500	
Water & Sewer	7,005	2,902	5,914	7,142	9,213	8,660	5,880	
Projects Carry Forward	1,184	-	8,627	-	1,281	-	-	(1)
	<b>28,397</b>	<b>17,746</b>	<b>26,383</b>	<b>23,458</b>	<b>17,968</b>	<b>17,016</b>	<b>14,586</b>	
<b>Net Revenue (Expenditures)</b>	<b>(9,590)</b>	<b>(2,202)</b>	<b>(8,014)</b>	<b>(3,125)</b>	<b>544</b>	<b>1,130</b>	<b>3,592</b>	
<b>Debt Principal Repayments</b>	<b>(689)</b>	<b>(706)</b>	<b>(746)</b>	<b>(736)</b>	<b>(649)</b>	<b>(473)</b>	<b>(319)</b>	
	<b>(689)</b>	<b>(706)</b>	<b>(746)</b>	<b>(736)</b>	<b>(649)</b>	<b>(473)</b>	<b>(319)</b>	
<b>Interfund Transfers</b>								
To Reserves	(4,163)	(4,163)	(1,859)	(1,859)	(3,113)	(2,087)	(4,590)	
From Reserves	13,257	8,284	1,921	2,490	1,937	1,430	1,317	
From SCFA Fund	-	-	-	-	-	-	-	
From Land Development Fund	-	-	70	58	-	-	-	
	<b>9,094</b>	<b>4,121</b>	<b>132</b>	<b>689</b>	<b>(1,176)</b>	<b>(657)</b>	<b>(3,273)</b>	
<b>Change in Fund Balance</b>	<b>(1,184)</b>	<b>1,214</b>	<b>(8,628)</b>	<b>(3,172)</b>	<b>(1,281)</b>	<b>-</b>	<b>-</b>	
<b>Opening Balance</b>	<b>1,184</b>	<b>3,285</b>	<b>8,628</b>	<b>4,499</b>	<b>1,326</b>	<b>45</b>	<b>45</b>	
<b>Closing Balance</b>	<b>-</b>	<b>4,499</b>	<b>-</b>	<b>1,326</b>	<b>45</b>	<b>45</b>	<b>45</b>	

**Note:**

(1) In 2011, the forecasted carryover project amount is \$8.8 million out of which \$7.5 million are funded by deferred revenues, primarily Gas Tax, and the balance \$1.3M is funded by Capital Fund's recognized revenues.

EXPENDITURE BY TYPE

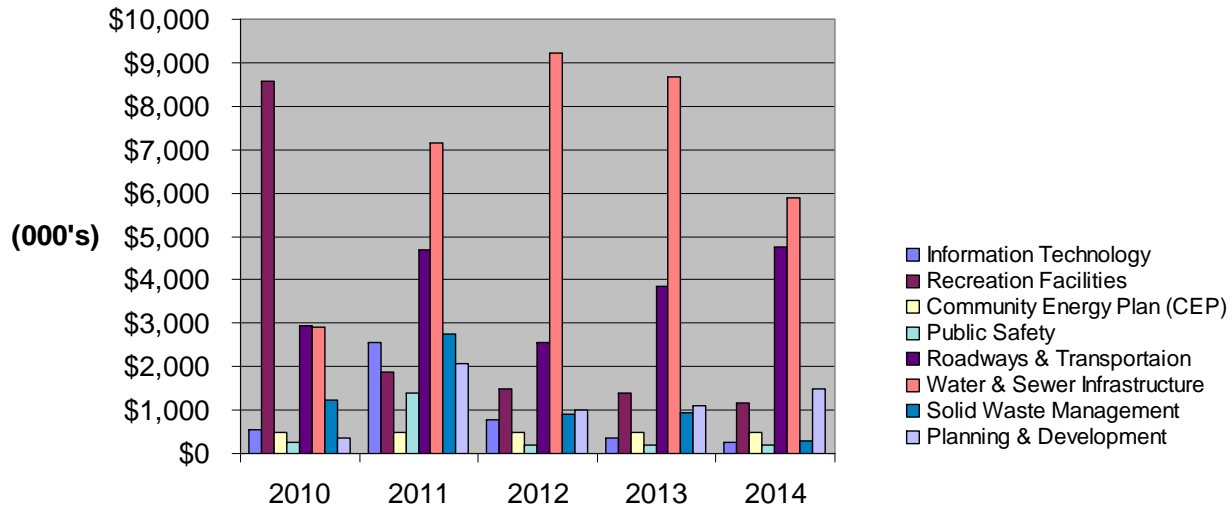

CAPITAL FUNDING BY TYPE

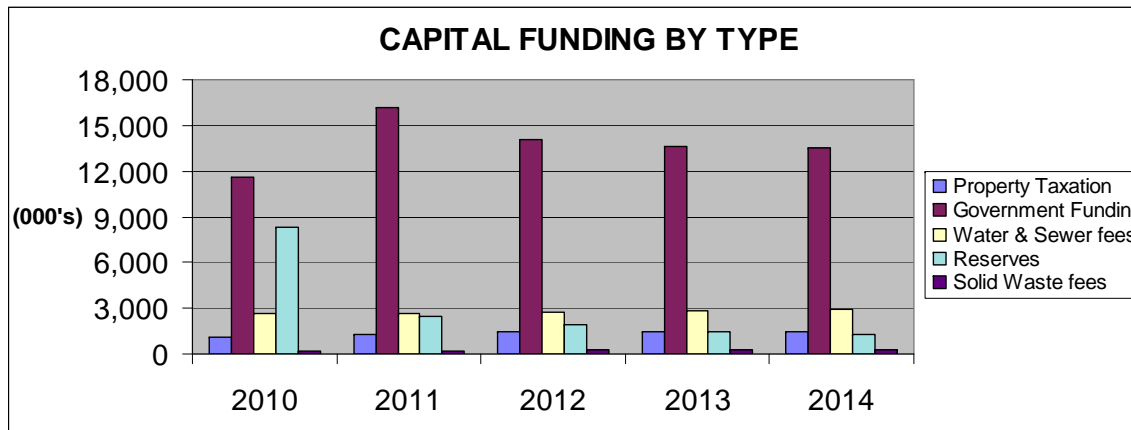

**2012 BUDGET CAPITAL FUND REVENUE (\$18.5M)**

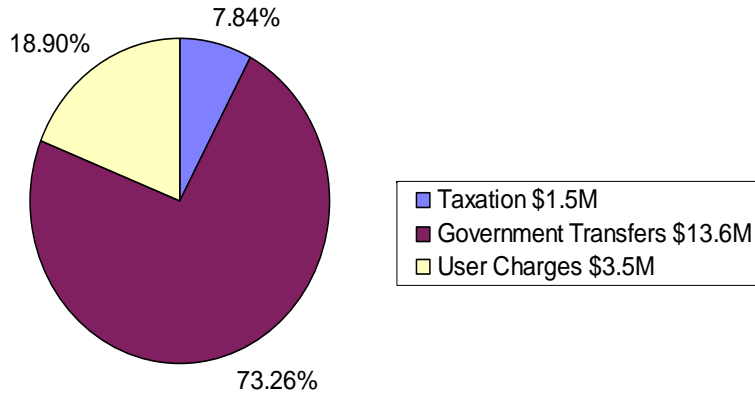

**2012 BUDGET CAPITAL FUND EXPENDITURES (\$16.7M)**

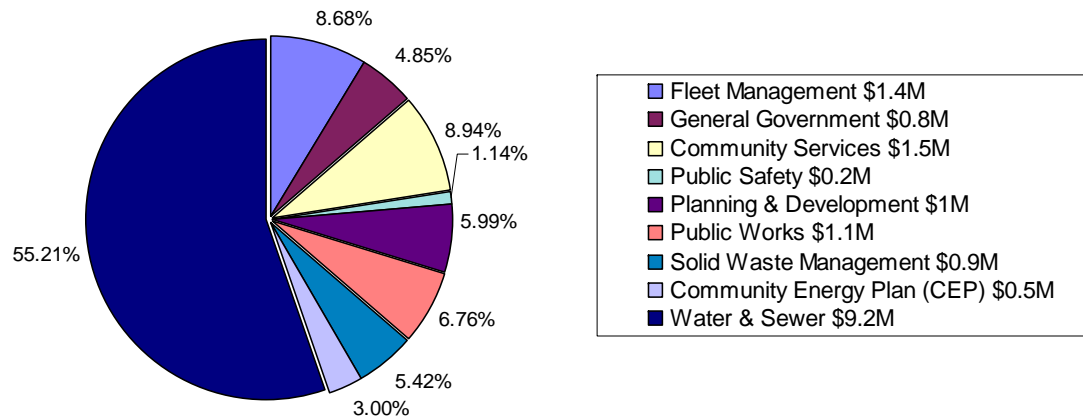



## CAPITAL FUND

### Capital Fund Expenditures

	2010 Budget (\$000's)	2010 Actual (\$000's)	2011 Budget (\$000's)	2011 Forecast (\$000's)	2012 Budget (\$000's)	2013 Budget (\$000's)	2014 Budget (\$000's)
<b>General Government</b>							
Administration	40	71	40	40	40	40	40
Community Capacity Building Fund (CCBF)	-	3	-	11	-	-	-
Information Technology	837	556	1,031	2,547	770	340	250
Debenture Interest	-	-	-	-	-	-	-
	<b>877</b>	<b>630</b>	<b>1,071</b>	<b>2,598</b>	<b>810</b>	<b>380</b>	<b>290</b>
<b>Community Services</b>							
Arenas	11,943	7,641	155	221	240	200	55
Library	-	20	-	45	-	-	-
Parks	315	525	288	323	736	1,050	845
Pool	55	194	280	257	150	80	200
Wildcat Café	-	4	385	525	-	-	-
City Hall	180	116	530	389	300	-	-
Debenture Interest	74	74	70	70	66	61	57
	<b>12,567</b>	<b>8,573</b>	<b>1,708</b>	<b>1,829</b>	<b>1,492</b>	<b>1,391</b>	<b>1,157</b>
<b>Public Safety</b>							
Directorate	-	-	-	-	15	-	-
Municipal Enforcement	-	-	282	281	-	-	-
Fire & Ambulance	168	254	960	1,119	175	210	205
Debenture Interest	-	-	-	-	-	-	-
	<b>168</b>	<b>254</b>	<b>1,242</b>	<b>1,400</b>	<b>190</b>	<b>210</b>	<b>205</b>
<b>Planning &amp; Development</b>	<b>500</b>	<b>343</b>	<b>950</b>	<b>2,085</b>	<b>1,000</b>	<b>1,100</b>	<b>1,500</b>
	<b>500</b>	<b>343</b>	<b>950</b>	<b>2,085</b>	<b>1,000</b>	<b>1,100</b>	<b>1,500</b>
<b>Public Works</b>							
Fleet Management	1,254	872	1,259	1,206	1,449	1,005	1,067
Engineering & Garage	260	244	940	206	220	70	50
Road Rehabilitation	1,700	1,695	3,165	3,163	810	2,732	3,610
Transit	20	31	20	33	20	20	20
Debenture Interest	138	117	82	82	78	23	7
	<b>3,372</b>	<b>2,959</b>	<b>5,466</b>	<b>4,689</b>	<b>2,577</b>	<b>3,850</b>	<b>4,754</b>
<b>Solid Waste</b>							
Landfill/Baling	2,224	1,218	905	2,737	905	925	300
	<b>2,224</b>	<b>1,218</b>	<b>905</b>	<b>2,737</b>	<b>905</b>	<b>925</b>	<b>300</b>
<b>Community Energy Plan (CEP)</b>	<b>500</b>	<b>866</b>	<b>500</b>	<b>976</b>	<b>500</b>	<b>500</b>	<b>500</b>
<b>Water &amp; Sewer</b>							
Pumphouses/Liftstations/Forcemains	4,080	505	2,609	3,265	6,413	5,855	2,000
Other	425	86	605	1,024	575	105	80
Water & Sewer Mains	2,500	2,311	2,700	2,854	2,225	2,700	3,800
Debenture Interest	-	-	-	-	-	-	-
	<b>7,005</b>	<b>2,902</b>	<b>5,914</b>	<b>7,142</b>	<b>9,213</b>	<b>8,660</b>	<b>5,880</b>
<b>Projects carried forward</b>	<b>1,184</b>	<b>-</b>	<b>8,627</b>	<b>-</b>	<b>1,281</b>	<b>-</b>	<b>-</b>
<b>TOTAL</b>	<b>28,397</b>	<b>17,745</b>	<b>26,383</b>	<b>23,456</b>	<b>17,968</b>	<b>17,016</b>	<b>14,586</b>



**CAPITAL FUND**

**Capital Financing**

	2010 Budget (\$000's)	2010 Actual (\$000's)	2011 Budget (\$000's)	2011 Forecast (\$000's)	2012 Budget (\$000's)	2013 Budget (\$000's)	2014 Budget (\$000's)
<b>Property Taxation</b>							
Debt							
Principal	689	706	746	736	649	473	319
Interest	212	191	152	152	144	84	64
Additional	187	187	539	411	659	895	1,069
	<b>1,088</b>	<b>1,084</b>	<b>1,436</b>	<b>1,299</b>	<b>1,452</b>	<b>1,452</b>	<b>1,452</b>

**Formula Funding**

	2010 Budget (\$000's)	2010 Actual (\$000's)	2011 Budget (\$000's)	2011 Forecast (\$000's)	2012 Budget (\$000's)	2013 Budget (\$000's)	2014 Budget (\$000's)
<b>Capital Projects:</b>							
General Government	313	241	434	434	240	40	40
Community Services	110	594	1,428	962	976	1,115	1,020
Planning & Development	500	51	950	950	-	1,100	1,500
Public Safety	168	174	1,242	1,242	190	210	205
Public Works	285	186	1,510	560	350	612	1,470
Solid Waste Mgmt	1,050	392	905	768	905	925	200
Community Energy Plan	500	238	500	500	500	500	500
Water & Sewer	186	157	43	43	2,066	1,434	80
<b>Reserves:</b>							
Information Technology	300	300	275	275	300	300	600
Major Community Facility	2,702	2,702	362	467	1,696	542	2,230
Mobile Equipment	764	764	780	780	742	870	1,385
Samuel Colley Donation Reserve	65	65	-	-	-	-	-
	<b>6,943</b>	<b>5,863</b>	<b>8,429</b>	<b>6,980</b>	<b>7,965</b>	<b>7,648</b>	<b>9,230</b>
Carry Forward (net)	-	-	-	-	-	-	-
	<b>6,943</b>	<b>5,863</b>	<b>8,429</b>	<b>6,980</b>	<b>7,965</b>	<b>7,648</b>	<b>9,230</b>
<b>Debt Payment / others</b>	<b>(187)</b>	<b>890</b>	<b>(1,676)</b>	<b>(227)</b>	<b>(1,212)</b>	<b>(895)</b>	<b>(2,477)</b>
<b>TOTAL</b>	<b>6,756</b>	<b>6,753</b>	<b>6,753</b>	<b>6,753</b>	<b>6,753</b>	<b>6,753</b>	<b>6,753</b>
Annual Contribution	<b>6,756</b>	<b>6,753</b>	<b>6,753</b>	<b>6,753</b>	<b>6,753</b>	<b>6,753</b>	<b>6,753</b>

## CAPITAL FUND

	2010 Budget (\$000's)	2010 Actual (\$000's)	2011 Budget (\$000's)	2011 Forecast (\$000's)	2012 Budget (\$000's)	2013 Budget (\$000's)	2014 Budget (\$000's)
<b>Other Grants</b>							
Government of Canada							
Gas Tax Rebate	4,764	871	4,519	5,523	4,519	4,519	4,519
Municipal Rural Infrastructure Fund (MRIF)	-	-	-	119	-	-	-
MRIF Innovation Fund	-	296	-	-	-	-	-
Community Capacity Building Fund	-	3	-	11	-	-	-
Infrastructure Stimulus Fund	685	317	-	368	-	-	-
Public Transit Funding	-	83	-	-	-	-	-
Others	-	488	-	396	-	-	-
Government of NWT							
MACA Capital Grant	2,210	2,210	2,210	2,210	2,210	2,210	2,210
MACA Recreation Grant	80	61	80	80	80	80	80
Others	-	223	-	-	-	-	-
Others	349	279	545	700	495	50	-
	<b>8,088</b>	<b>4,830</b>	<b>7,354</b>	<b>9,407</b>	<b>7,304</b>	<b>6,859</b>	<b>6,809</b>
<b>User Charges</b>							
Solid Waste Allocation							
Mobile Equipment Reserve	214	214	181	181	260	260	260
	<b>214</b>	<b>214</b>	<b>181</b>	<b>181</b>	<b>260</b>	<b>260</b>	<b>260</b>
Water & Sewer Allocation							
Mobile Equipment Reserve	118	118	156	156	115	115	115
Additional	1,152	1,128	1,099	1,142	1,226	1,299	1,373
	<b>1,270</b>	<b>1,246</b>	<b>1,255</b>	<b>1,298</b>	<b>1,341</b>	<b>1,414</b>	<b>1,488</b>
Other							
Water & Sewer Infrastructure Levy	1,392	1,386	1,390	1,395	1,402	1,409	1,416
Sale of Capital Assets	-	32	-	-	-	-	-
	<b>1,392</b>	<b>1,419</b>	<b>1,390</b>	<b>1,395</b>	<b>1,402</b>	<b>1,409</b>	<b>1,416</b>
	<b>2,876</b>	<b>2,878</b>	<b>2,826</b>	<b>2,874</b>	<b>3,003</b>	<b>3,082</b>	<b>3,164</b>



**CAPITAL FUND**

	2010 Budget (\$000's)	2010 Actual (\$000's)	2011 Budget (\$000's)	2011 Forecast (\$000's)	2012 Budget (\$000's)	2013 Budget (\$000's)	2014 Budget (\$000's)
<b>Interfund Transfers</b>							
To Reserves:							
Information Technology	(300)	(300)	(275)	(275)	(300)	(300)	(600)
Major Community Facility	(2,702)	(2,702)	(467)	(467)	(1,696)	(542)	(2,230)
Mobile Equipment	(1,096)	(1,096)	(1,117)	(1,117)	(1,117)	(1,245)	(1,760)
Samuel Colley Donation Reserve	(65)	(65)	-	-	-	-	-
Twin Pine Hill Trail	-	-	-	-	-	-	-
	<b>(4,163)</b>	<b>(4,163)</b>	<b>(1,859)</b>	<b>(1,859)</b>	<b>(3,113)</b>	<b>(2,087)</b>	<b>(4,590)</b>
From Reserves:							
Information Technology	345	387	637	780	313	340	250
Major Community Facility	11,658	6,991	-	254	-	-	-
Mobile Equipment	1,254	873	1,259	1,206	1,449	1,005	1,067
Downtown Development Reserve	-	34	-	250	-	-	-
Samuel Colley Donation Reserve	-	-	-	-	-	-	-
Twin Pine Hill Trail Reserve	-	-	25	-	175	85	-
	<b>13,257</b>	<b>8,284</b>	<b>1,921</b>	<b>2,490</b>	<b>1,937</b>	<b>1,430</b>	<b>1,317</b>
From Land Development Fund:							
To Capital Fund	-	-	70	58	-	-	-

THIS PAGE LEFT BLANK INTENTIONALLY



**CAPITAL FUND - 2012 Capital Projects**

---

	2010 Budget (\$000's)	2010 Actual (\$000's)	2011 Budget (\$000's)	2011 Forecast (\$000's)	2012 Budget (\$000's)	2013 Budget (\$000's)	2014 Budget (\$000's)
<b>General Government</b>							
Administration							
Tourism Marketing & Development	40	40	40	40	40	40	40
Mid-Volume Copier/Printer/Scanner	-	31	-		-	-	-
	40	71	40	40	40	40	40
Community Capacity Building Fund (CCBF)							
911 - Emergency Services	-	3	-	11	-	-	-
	-	3	-	11	-	-	-

**CAPITAL FUND - 2012 Capital Projects**

	2010 Budget (\$000's)	2010 Actual (\$000's)	2011 Budget (\$000's)	2011 Forecast (\$000's)	2012 Budget (\$000's)	2013 Budget (\$000's)	2014 Budget (\$000's)
Information Technology							
Network Upgrades	25	24	25	25	25	25	25
GIS Enhancements	50	67	50	50	50	50	50
Server Replacement	25	25	25	25	25	25	25
Mobile Inspections	-	-	20	15	-	-	-
Phone System Replacement	-	97	-	6	-	-	-
Desktop Telephone Replacement	-	-	-	-	-	10	-
Satellite Imagery	25	25	-	-	-	75	-
Communication Infrastructure	492	170	481	1,854	150	-	-
Payment Card Industry Compliance	25	22	50	67	-	-	-
Security Cameras	25	24	50	50	20	20	20
Voice Radio Support Equipment	75	-	-	75	-	-	-
Secondary Site & Data Replication	20	24	20	20	20	10	10
Laptops For Patrol Vehicles	10	9	35	27	-	-	-
Library Public Access Expansion / Stations	-	-	25	25	-	-	-
Swipe Card System	-	12	-	-	-	-	-
MED In-Car Cameras	-	-	35	35	-	-	-
MED Web Applications	-	-	20	20	-	-	-
Collections Modules	-	-	-	15	-	-	-
Website Redesign/Enhancement	30	29	15	15	15	15	15
Server Room Upgrades	-	-	-	-	-	25	-
Citrix Expansion	25	24	-	1	-	-	-
Exchange & Office 2007	10	-	-	10	-	-	-
Asset Management	-	-	-	52	50	-	-
Information Technology Strategy Plan	-	6	-	-	-	-	-
Core Switch Upgrades	-	-	-	-	-	-	25
Core Router Updates	-	-	20	20	-	-	-
Citizen Request Management System	-	-	75	75	-	-	-
Webcasting	-	-	20	-	-	-	-
Email Management	-	-	40	40	-	-	-
Inventory Bar Coding	-	-	25	25	-	-	-
Virtualization	-	-	-	-	40	40	40
Layer Three Access Switches	-	-	-	-	20	-	-
One- Stop Shopping	-	-	-	-	20	-	-
Wireless Authentication/ Authorization	-	-	-	-	25	-	-
Wireless Standardization	-	-	-	-	-	20	-
Meeting Automation	-	-	-	-	100	-	-
Development and Building Permit Automation	-	-	-	-	75	25	-
Human Resources System Automation	-	-	-	-	100	-	-
Status Keeping Software	-	-	-	-	35	-	-
Automated Ticket Writer	-	-	-	-	-	-	40
	837	556	1,031	2,547	770	340	250



**CAPITAL FUND - 2012 Capital Projects**

---

		2012 Budget Recommended (\$000s)	Formula Funding (\$000s)	IT Reserve (\$000s)	MACA Capital Grant (\$000s)
	<b>Page #</b>				
<b>General Government</b>					
Tourism Marketing & Development	208	40	40		
		40	40	-	-
<b>Information Technology</b>					
Network Upgrades	209	25		25	
GIS Enhancements	210	50		50	
Server Replacement	211	25		25	
Communication Infrastructure	212	150	150		
Security Cameras	214	20		13	7
Secondary Site & Data Replication	215	20			20
Website Enhancements	216	15			15
Asset Management	217	50	50		
Virtualization	218	40			40
Layer Three Access Switches	219	20			20
One-Stop Shopping	220	20			20
Wireless Authentication/ Authorization	221	25			25
Meeting Automation	222	100		100	
Development and Building Permit Automation	224	75			75
Human Resources Process Automation	225	100		100	
Status Keeping Software	226	35			35
		770	200	313	257
<b>Subtotal</b>		810	240	313	257



## CAPITAL FUND - 2012 Capital Projects

---

**DEPARTMENT** ECONOMIC DEVELOPMENT

**DIVISION** ECONOMIC DEVELOPMENT

**PROJECT** Tourism Marketing & Development

**COST**

2012	\$40,000
2013	\$40,000
2014	\$40,000

**STATUS** Ongoing

**DESCRIPTION** This program is designed to respond to opportunities for growth in the tourism development and marketing sectors. Addressing the lack of tourism product and the provision of tourism support services is an NWT priority.

Whenever possible, this program utilizes partnerships and shared funding arrangements with NWT Tourism, Northern Frontier Visitors Association, Government of the Northwest Territories, the federal government, and representative private sector groups to advance tourism initiatives.

This funding has been in place on an ongoing basis since 2006.

Specific opportunities for 2012 and beyond include, but are not limited to:

- Celebration of the Deh Cho Travel Connection – Diamonds in the Rough Passport Program’s fifth anniversary. The program is a scenic touring route that links Alaska, Mackenzie and Liard Highways, with side trips through Fort Smith, Wrigley and Yellowknife. Visitors with a fully stamped passport are eligible to win a Government Certified Canadian Diamond™ that was mined, cut and polished in the NWT.
- Partnering with NWT Tourism and private sector partners to develop the first-ever Northwest Territories Outdoor Sportsmen’s Show in Edmonton in 2012. The event will be tourism-driven, supported by industry

partners, and will showcase Yellowknife and NWT operators and their product to outdoor and sportsmen enthusiasts.

- Ongoing participation in research and promotional activities related to Canadian capital cities involvement in Canada 150: Connecting Canadians and Celebrating Canada. The celebration of Canada’s 150<sup>th</sup> birthday takes place in 2017 and Canadian Capital Cities Organization (CCCO) is considering promotional opportunities for capital cities leading up to and including the 2017 celebration.
- Design and annual purchase of street banners. Banner themes include Yellowknife icons, National Capital Commission and Canadian Capital Cities Organization celebrations. These banners are used for festivals and special events, and typically displayed in the City Hall/Somba K’e Civic Plaza area, and along Wiley Road, Franklin Avenue and Old Airport Road.
- Ongoing project-oriented partnership funding to upgrade, repair and enhance city focused/themed displays and messages at the Northern Frontier Visitors Centre (exterior and interior).

This project works toward City Council’s Goals #2<sup>1</sup> and 3<sup>2</sup>.

**O&M IMPACT**

Minor – will be addressed with existing resources.

---

<sup>1</sup> Enhancing Our Built Environment

<sup>2</sup> Building Social Capital (Community Engagement)



## CAPITAL FUND - 2012 Capital Projects

---

**DEPARTMENT** CORPORATE SERVICES

**DIVISION** INFORMATION TECHNOLOGY

**PROJECT** Network Upgrades

**COST**

2012	\$25,000
2013	\$25,000
2014	\$25,000

**STATUS** Replacement

**PHASE** Ongoing

**DESCRIPTION** The City's Information Technology infrastructure is essential for effective service delivery, and the network that provides connectivity among its diverse computers, servers, printers, cameras, and mobile devices is vital to the City's operations.

As employee and stakeholder demands and reliance on the network continue to grow, it is critical that network capacity and reliability keep pace through regular ongoing enhancements. This incremental approach has proven highly effective in recent years as it minimizes service disruptions, enables the exploitation of technological improvements, and maximizes the City's return on its investments.

This initiative will continue the organization's ongoing network enhancements and improve redundancy, security, and capacity, with a specific emphasis on integrated monitoring and reporting to provide proactive and predictive management. This enhanced foundation will protect the City's existing network availability and ensure the network is well-situated to meet current and future demands.

This project works toward City Council's Goals #1<sup>1</sup> and #4<sup>2</sup>, Objectives #1.4<sup>3</sup> and #4.4<sup>4</sup>, and Actions #4(a)<sup>5</sup> and #4(b)<sup>6</sup>.

**O&M IMPACT**

This project does not directly impact O&M expenditures. However, if network maintenance and enhancements are diminished the network will soon be unable to meet the increasing demands being placed on it. Resulting service delays, interruptions, and outages will negatively impact staff productivity throughout the organization and severely limit the organization's ability to provide citizen services.

- 
- <sup>1</sup> Affordability
  - <sup>2</sup> Continuous Improvement
  - <sup>3</sup> Emphasize fairness and transparency in financial decisions, program delivery and land assembly.
  - <sup>4</sup> Be a leader in innovation.
  - <sup>5</sup> Develop a customer service culture.
  - <sup>6</sup> Lead in innovation and best practices.

## CAPITAL FUND - 2012 Capital Projects

---

<b>DEPARTMENT</b>	<b>CORPORATE SERVICES</b>
<b>DIVISION</b>	<b>INFORMATION TECHNOLOGY</b>
<b>PROJECT</b>	<b>GIS Enhancements</b>
<b>COST</b>	2012 \$50,000 2013 \$50,000 2014 \$50,000
<b>STATUS</b>	<b>Replacement</b>
<b>PHASE</b>	<b>Ongoing</b>

**DESCRIPTION** cityExplorer – the City’s geographic information system – has proven to be a powerful and popular tool for both staff and citizens. It provides intuitive, single window access to diverse data from across the organization and is a dynamic, evolving entity that can continue to grow and expand in response to user requirements; its features and capabilities are limited only by its stakeholders’ imaginations.

In order to maintain and grow the value of this system, the data must be current, accurate, and relevant. This requires an ongoing investment of both people and financial resources. Likewise, expenditures are necessary to ensure the system progresses towards its potential and remains responsive to its users.

To achieve this, the Information Technology Division has developed a strategy of sustained investment in the system, its data, and its capabilities. It has also established an EGIS Technical Advisory Committee to review progress and identify and set priorities for future developments.

This project reflects the requirement for the regular, predictable expenditures that are essential to ensure the upkeep and growth of cityExplorer. Enhancements

identified for 2012 include the final migration and implementation of the ArcGIS Server platform. This will introduce major technical advancements in the ESRI platform that underlies cityExplorer, and provide the basis for more powerful tools and increasingly sophisticated features. As well, another assessment will be undertaken to solicit input and direction from staff and stakeholders.

Plans for 2013 and 2014 include: Asset Management integrations; an online Map Gallery; a Google Earth tie-in; enhanced document management, CAD and record drawing integration; and online data editing capabilities.

This project works toward City Council’s Goals #1<sup>1</sup>, #3<sup>2</sup> and #4<sup>3</sup>, Objectives #1.4<sup>4</sup>, #3.3<sup>5</sup>, #3.4<sup>6</sup> and #4.4<sup>7</sup>, and Actions #4(a)<sup>8</sup> and #4(b)<sup>9</sup>.

**O&M IMPACT**

This project does not directly impact O&M expenditures, but does enable City staff to work more efficiently and provide improved services.

- 
- <sup>1</sup> Affordability
  - <sup>2</sup> Building Social Capital (Community Engagement)
  - <sup>3</sup> Continuous Improvement
  - <sup>4</sup> Emphasize fairness and transparency in financial decisions, program delivery and land assembly.
  - <sup>5</sup> Improve community participation and volunteerism opportunities.
  - <sup>6</sup> Promote heritage, culture, arts and other unique characteristics of Yellowknife to honour our past and preserve/showcase our history and cultural diversity.
  - <sup>7</sup> Be a leader in innovation.
  - <sup>8</sup> Develop a Customer Service Culture.
  - <sup>9</sup> Lead in Innovation and Best Practices.



## CAPITAL FUND - 2012 Capital Projects

---

**DEPARTMENT** CORPORATE SERVICES

**DIVISION** INFORMATION TECHNOLOGY

**PROJECT** Server Replacement

**COST**

2012	\$25,000
2013	\$25,000
2014	\$25,000

**STATUS** Replacement

**PHASE** Ongoing

**DESCRIPTION** The Information Technology Division maintains numerous servers to support a wide range of services to citizens and staff. These computers are essential to the operations of the City and it is crucial that the City's investment in this equipment be adequately protected and leveraged.

In recent years, significant progress has been made in standardizing the server platform and reducing the diversity and complexity involved in supporting and maintaining the servers. This has enabled the Information Technology Division to establish a solid server fleet that can be supported and maintained in an effective manner.

It has also been recognized that this equipment has a limited lifespan that necessitates regular replacement cycles. Thus the Information Technology Division has also developed an effective strategy for replacing and redeploying servers to obtain maximum benefit to the City. This strategy is continually evolving to make the most of technological advances and to attain more efficient and greener service delivery.

It is essential that these standards and the replacement strategy be maintained to ensure the performance and

reliability demands of staff and citizens can continue to be met. This requires sustained investment in the server fleet, with the goal of regular, predictable expenditures.

This project works toward City Council's Goals #1<sup>1</sup> and #4<sup>2</sup>, Objectives #1.4<sup>3</sup> and #4.4<sup>4</sup>, and Actions #4(a)<sup>5</sup> and #4(b)<sup>6</sup>.

### O&M IMPACT

This project does not directly impact O&M expenditures; however if regular refreshes are not sustained there will be increased equipment failure rates and degraded system performance levels, both of which will negatively impact productivity. In the event of a server failure, there could be service interruptions to both staff and citizens.

- 
- 1 Affordability
  - 2 Continuous Improvement
  - 3 Emphasize fairness and transparency in financial decisions, program delivery and land assembly.
  - 4 Be a leader in innovation.
  - 5 Develop a Customer Service Culture.
  - 6 Lead in innovation and best practices.

## CAPITAL FUND - 2012 Capital Projects

---

<b>DEPARTMENT</b>	<b>CORPORATE SERVICES</b>
<b>DIVISION</b>	<b>INFORMATION TECHNOLOGY</b>
<b>PROJECT</b>	<b>Communications Infrastructure</b>
<b>COST</b>	<b>2012 \$150,000</b>
<b>STATUS</b>	<b>Replacement</b>
<b>PHASE</b>	<b>4 of 4</b>
<b>DESCRIPTION</b>	<p>The City's radio system supports voice radio communications for the Public Safety, Public Works, and Community Services departments.</p> <p>In 2007, the City initiated a review of its current radio communications system to establish its effectiveness, determine user acceptability, and recognize deficiencies with current capabilities vis-à-vis industry practices and standards.</p> <p>This study identified several issues, including:</p> <ul style="list-style-type: none"><li>• The existing infrastructure provided limited to poor coverage in certain areas of the city, particularly for portable radios and within building structures.</li><li>• The existing radio channel resources were not compliant with key National Fire Prevention Association (NFPA) requirements.</li><li>• The dispatch location and operation do not meet key NFPA standards for system reliability and monitoring.</li><li>• Much of the equipment was obsolete, and many of the radios were at the end of their operational life and in need of replacement.</li></ul> <p>The study also presented a three-step initiative to rectify these deficiencies and develop a robust and reliable communications system that will protect the City's</p>

employees, citizens, and property; the approach was both unique and practical because each stage built upon the preceding efforts and investments.

In 2010, the first phase left the existing system generally intact but remedied critical inadequacies by providing high-tier portables for the Fire Division, re-engineering antenna filtering, upgrading the Fire Division channels and dispatch consoles, and purchasing equipment maintenance agreements.

The second phase also began in 2010, and progressed through 2011. It took a longer-term approach to establish a solid foundation that better adheres to applicable NFPA standards. Accomplishments included: expanded channels; overlapping zones of radio coverage; new repeater/voter sites; a communications backhaul system; new portables, mobiles, and pagers; and an upgraded Emergency Operations Centre communications system. This phase represented a significant, yet essential, investment of resources.

In 2012, mobile data capacity will be added to the infrastructure to support a wide range of potential applications. These include: automatic vehicle location to monitor fleet vehicles to help protect staff working alone or in dangerous situations and to provide information for enhanced service delivery; automated water meter reading to improve reading accuracy, frequency, and processing; remote access to centrally stored data to boost the efficiency and effectiveness of staff working in the field; and remote monitoring of the City's water and sewer controls (SCADA) to provide more timely feedback and response.

### Budget

This project arose out of the Radio Replacement Study, budgeted for 2007. As the study was not completed until 2008, the original funding was carried over to that year. The study incurred a slight cost overrun, which



**CAPITAL FUND - 2012 Capital Projects**

---

was carried forward and covered by the 2009 funding for the Communications Infrastructure project.

<i>Year</i>	<i>Budget</i>	<i>Carry Forward</i>	<i>Available</i>	<i>Actuals</i>	<i>Balance</i>
2007	\$50,000		\$50,000	\$0	\$50,000
2008	\$0	\$50,000	\$50,000	\$55,339	-\$5,339

Initial work on the Communications Infrastructure project did not proceed as quickly as projected due to the unexpected reliance on outside contractors. Therefore \$1,323,083 was carried forward to 2010 and subsequently \$1,645,059 was carried forward to 2011. Revised plans to complete the most expensive portion of the project – the construction of the redundant backhaul infrastructure – have been further delayed in 2011 due to major vendor strategy changes and uncertainties surrounding product availability. Therefore it is anticipated that there will be another significant carryover to facilitate project completion in 2012.

<i>Year</i>	<i>Budget</i>	<i>Carry Forward</i>	<i>Available</i>	<i>Projected</i>	<i>Balance</i>
2009	\$1,363,000	-\$5,339	\$1,357,661	\$34,578	\$1,323,083
2010	\$492,000	\$1,323,083	\$1,815,083	\$170,024	\$1,645,059
2011	\$481,000	\$1,645,059	\$2,126,059	\$308,730	\$1,817,329
2012	\$150,000	\$1,817,329	\$1,967,329	\$1,967,329	\$0

This project works toward City Council's Goals #1<sup>1</sup> and #4<sup>2</sup>, Objectives #1.4<sup>3</sup> and #4.4<sup>4</sup>, and Action #4(b)<sup>5</sup>.

**O&M IMPACT**

It is anticipated that the new system will reduce equipment maintenance costs. However, it will require dedicated support resources equivalent to at least one full-time employee.

- 
- <sup>1</sup> Affordability
  - <sup>2</sup> Continuous Improvement
  - <sup>3</sup> Be a leader in innovation.
  - <sup>4</sup> Emphasize fairness and transparency in financial decisions, program delivery and land assembly.
  - <sup>5</sup> Lead in innovation and Best Practices.

## CAPITAL FUND - 2012 Capital Projects

---

<b>DEPARTMENT</b>	<b>CORPORATE SERVICES</b>
<b>DIVISION</b>	<b>INFORMATION TECHNOLOGY</b>
<b>PROJECT</b>	<b>Security Cameras</b>
<b>COST</b>	2012 \$20,000 2013 \$20,000 2014 \$20,000
<b>STATUS</b>	Replacement
<b>PHASE</b>	Ongoing
<b>DESCRIPTION</b>	<p>Security cameras have proven to be an essential tool in the ongoing effort to protect the City's facilities and its citizens.</p> <p>Early initiatives were addressed as independent projects, often in response to events and circumstances. While this one-off approach met emergent requirements, as the camera fleet and associated back-end infrastructure and support efforts grew, it became increasingly apparent that a more integrated, ongoing approach was essential.</p> <p>A major expansion was completed in 2011 to update back-end software, storage, and server capabilities, and install additional cameras to address growing security concerns at various City facilities. In subsequent years, regular and predictable expenditures will ensure ongoing renewal of existing security camera infrastructure.</p> <p>This project works toward City Council's Goals #1<sup>1</sup> and #4<sup>2</sup>, Objectives #1.4<sup>3</sup> and #4.4<sup>4</sup> and Action #4(b)<sup>5</sup>.</p>

**O&M IMPACT** There will be minor increases in software maintenance costs as additional licencing is obtained, however if regular refreshes are not maintained, outages could escalate security risks and increase troubleshooting and support time and repair costs.

- 
- <sup>1</sup> Affordability
  - <sup>2</sup> Continuous Improvement
  - <sup>3</sup> Emphasize fairness and transparency in financial decisions, program delivery and land assembly.
  - <sup>4</sup> Be a leader in innovation.
  - <sup>5</sup> Lead in innovation and best practices.



## CAPITAL FUND - 2012 Capital Projects

---

**DEPARTMENT** CORPORATE SERVICES

**O&M IMPACT** This expenditure will not directly impact O&M but will significantly decrease the City's risk exposure.

**DIVISION** INFORMATION TECHNOLOGY

**PROJECT** Secondary Site and Data Replication

**COST**

2012	\$20,000
2013	\$10,000
2014	\$10,000

**STATUS** New

**PHASE** Ongoing

**DESCRIPTION** The City's Information Technology infrastructure, and the data maintained within it, are critical to the City's operations. Any failures or downtime will significantly impede the organization's ability to deliver services. Therefore, it is imperative that a disaster recovery plan be finalized and a secondary site established to create the necessary redundancy to continue operations in the event that the City's primary data centre is compromised.

This initiative began as a three-year project to establish a secondary site. Preliminary work was completed in 2010, and development efforts continued through 2011 with the redeployment and acquisition of infrastructure to create the foundation for an off-site data centre. Basic functionality for critical applications and services will be introduced in 2012.

It is now apparent that continued, incremental enhancements of this secondary site will be crucial to maintaining an increasingly functional off-site data centre capable of resuming and sustaining operations in a timely fashion, should the need arise.

This project works toward City Council's Goals #1<sup>1</sup> and #4<sup>2</sup>, Objectives #1.4<sup>3</sup> and #4.4<sup>4</sup>, and Action #4(b)<sup>5</sup>.

- 
- <sup>1</sup> Affordability
  - <sup>2</sup> Continuous Improvement
  - <sup>3</sup> Emphasize fairness and transparency in financial decisions, program delivery and land assembly.
  - <sup>4</sup> Be a leader in innovation.
  - <sup>5</sup> Lead in innovation and best practices.



## CAPITAL FUND - 2012 Capital Projects

---

**DEPARTMENT** CORPORATE SERVICES

**DIVISION** INFORMATION TECHNOLOGY

**PROJECT** Website Enhancements

**COST**

2012	\$15,000
2013	\$15,000
2014	\$15,000

**STATUS** Replacement

**PHASE** Ongoing

**DESCRIPTION** The City's website is an established component of the organization's communication and engagement strategies, and technological advances and expanding expectations are creating opportunities for more effective and efficient uses of this tool.

The site was redesigned in 2009 to update its look and feel, organize content more intuitively, and incorporate new technologies and techniques to improve its functionality. Enhancements made in 2010 and 2011 built on this foundation and were well received by both internal and external clients.

Ongoing enhancements are essential to the viability and growth of the City's website, and these require sustained and predictable investments. By allocating funds for continuous improvement, the City can exploit new technologies to more effectively and efficiently provide improved information and services to its clients.

This project works toward City Council's Goals #1<sup>1</sup>, #3<sup>2</sup> and #4<sup>3</sup>, Objectives #1.4<sup>4</sup>, #3.3<sup>5</sup>, #3.4<sup>6</sup> and #4.4<sup>7</sup>, and Actions #4(a)<sup>8</sup> and #4(b)<sup>9</sup>.

**O&M IMPACT** This project may result in a small increase in software maintenance costs but it enables City staff to work more efficiently, communicate more effectively, and provide improved services.

- 
- <sup>1</sup> Affordability
  - <sup>2</sup> Building Social Capital (Community Engagement)
  - <sup>3</sup> Continuous Improvement
  - <sup>4</sup> Emphasize fairness and transparency in financial decisions, program delivery and land assembly.
  - <sup>5</sup> Improve community participation and volunteerism opportunities.
  - <sup>6</sup> Promote heritage, culture, arts and other unique characteristics of Yellowknife to honour our past and preserve/showcase our history and cultural diversity.
  - <sup>7</sup> Be a leader in innovation.
  - <sup>8</sup> Develop a Customer Service Culture.
  - <sup>9</sup> Lead in innovation and best practices.



## CAPITAL FUND - 2012 Capital Projects

---

**DEPARTMENT** CORPORATE SERVICES

**DIVISION** INFORMATION TECHNOLOGY

**PROJECT** Asset Management

**COST** \$50,000

**STATUS** New

**PHASE** 1 of 1

**DESCRIPTION** GIS-integrated Asset Management software for Public Works which can generate work orders based on service requests as well help the City manage fleet maintenance.

The project deals with the purchase of asset management software that will form an integral part of the Management Operating System currently employed by the Department of Public Works & Engineering. The software will be capable of tracking data on job costing, work performed, and the equipment, materials and manpower used. The new software will provide a systematic approach to track service requests while generating work orders. This will allow the City to receive concerns and complaints from the residents and almost instantaneously create a service request. The tracking system will allow the department to identify trouble spots and trends which can then be used to make more effective decisions when it comes to the planning and scheduling of capital projects. The tracking system that forms part of the core of the system will allow the City to respond to citizens with instant and accurate information.

Another key component of the software is the Fleet Maintenance module which is capable of managing all aspects of fleet and equipment maintenance. This component will keep track of the maintenance history,

depreciation, replacement scheduling and fuel consumption of each vehicle.

The software will allow staff to create reports tracking costs, which can then be used to generate key progress indicators and then allow staff to determine how effective and efficient the City is.

This project works toward City Council's Goals #1<sup>1</sup> and #4<sup>2</sup>, Objectives #1.4<sup>3</sup> and #4.4<sup>4</sup>, and Actions 4(a)<sup>5</sup> and 4(b)<sup>6</sup>.

### O&M IMPACT

This project will increase annual software maintenance costs by approximately \$19,000.

- 
- <sup>1</sup> Affordability
  - <sup>2</sup> Continuous Improvement.
  - <sup>3</sup> Emphasize fairness and transparency in financial decisions, program delivery and land assembly.
  - <sup>4</sup> Be a leader in innovation.
  - <sup>5</sup> Develop a customer service culture.
  - <sup>6</sup> Lead in innovation and best practices.

## CAPITAL FUND - 2012 Capital Projects

---

**DEPARTMENT** CORPORATE SERVICES

**DIVISION** INFORMATION TECHNOLOGY

**PROJECT** Virtualization

**COST**

2012	\$40,000
2013	\$40,000
2014	\$40,000

**STATUS** New

**PHASE** 1 of 3

**DESCRIPTION** The Information Technology Division maintains numerous servers and computers to support a wide range of services to citizens and staff. It is continually assessing technologies and opportunities for improving the performance of this infrastructure to support more efficient and effective delivery of services.

In 2009, the division began to explore the potential for virtualization within the City's infrastructure. This technology creates an additional layer that separates the logical and physical levels and thus makes it possible to create multiple logical servers or desktops on a single physical server. This increasingly centralized paradigm means resources can be concentrated: several small servers can be replaced by one larger server, thereby more fully utilizing the resources of that single box, reducing space, power consumption, and cooling requirements, and streamlining support efforts.

The division has identified numerous opportunities where the technology could improve reliability, boost flexibility, and reduce support demands, and in 2010 implemented some server virtualization as a proof-of-concept. Based on the success of this initiative, further server virtualization was deployed and virtual desktops were rolled out to selected clients in 2011.

Virtualization has proven to be a good fit for the City of Yellowknife, and the Information Technology Division will continue to exploit it as appropriate. This will require shifting computing power and data storage investments from a distributed model to a more centralized approach. It will also be necessary to invest in appropriate tools and support to ensure the centralized services are properly configured for the City's needs and remain highly available for clients.

To this end, it is anticipated that 24x7 technical support for the associated software (XenDesktop, XenServer, and XenApp) and hardware (NetScaler) will be purchased in each of the upcoming years. In 2012, acquisitions will also include two additional stand-alone servers and two additional blade servers to provide adequate centralized computing power. 2013 purchases will include a second NetScaler to establish redundancy and additional Microsoft Terminal Services licenses to accommodate increased demand. Two more servers will be added in 2014 to keep pace with expanding demands and requirements.

This project works toward City Council's Goals #1<sup>1</sup> and #4<sup>2</sup>, Objectives #1.4<sup>3</sup> and #4.4<sup>4</sup>, and Action #4(b)<sup>5</sup>.

---

<sup>1</sup> Affordability

<sup>2</sup> Continuous Improvement

<sup>3</sup> Emphasize fairness and transparency in financial decisions, program delivery and land assembly.

<sup>4</sup> Be a leader in innovation.

<sup>5</sup> Lead in innovation and best practices.



## CAPITAL FUND - 2012 Capital Projects

---

**DEPARTMENT** CORPORATE SERVICES

**DIVISION** INFORMATION TECHNOLOGY

**PROJECT** Layer Three Access Switches

**COST** \$20,000

**STATUS** New

**PHASE** 1 of 1

**DESCRIPTION** The City's network undergoes regular, incremental improvements to sustain its functionality. This strategy has proven to be an effective way to grow and expand the network to meet increasing demands and expectations. However, there remains the occasional need for a more significant investment to enhance the infrastructure and thus it is recommended that the City address access switch redundancy and elevated licencing in 2012.

This enhanced foundation will protect the City's existing investment in its network, and ensure the network is able to meet current and future demands.

This project works toward City Council's Goals #1<sup>1</sup> and #4<sup>2</sup>, Objectives #1.4<sup>3</sup> and #4.4<sup>4</sup>, and Action #4(b)<sup>5</sup>.

**O&M IMPACT** This project will not directly impact O&M expenditures.

- 
- <sup>1</sup> Affordability
  - <sup>2</sup> Create an environment of mutual respect, open dialogue, and team work.
  - <sup>3</sup> Emphasize fairness and transparency in financial decisions, program delivery and land assembly.
  - <sup>4</sup> Be a leader in innovation.
  - <sup>5</sup> Lead in innovation and best practices.

## CAPITAL FUND - 2012 Capital Projects

---

**DEPARTMENT** CORPORATE SERVICES

**DIVISION** INFORMATION TECHNOLOGY

**PROJECT** One-Stop Shopping

**COST** \$20,000

**STATUS** New

**PHASE** 1 of 1

**DESCRIPTION** The corporate One-Stop Shopping initiative will enable the City to provide improved customer service and to benefit from operational efficiencies.

It will also require a modest investment in information technology infrastructure to accommodate revised space layouts and support new job responsibilities. This includes:

- Wiring and cabling changes
- Additional workstations and printers for break-out rooms
- Phone system modifications

This project works towards City Council's Goals #1<sup>1</sup> and #4<sup>2</sup>, Objectives #1.4<sup>3</sup> and #4.4<sup>4</sup>, and Actions #4(a)<sup>5</sup> and #4(b)<sup>6</sup>.

**O&M IMPACT** These changes will not directly impact O&M expenditures, but will enable changes that will reduce operational costs and improve customer service levels.

- 
- <sup>1</sup> Affordability
  - <sup>2</sup> Continuous Improvement
  - <sup>3</sup> Emphasize fairness and transparency in financial decisions, program delivery and land assembly.
  - <sup>4</sup> Be a leader in innovation.
  - <sup>5</sup> Develop a Customer Service Culture.
  - <sup>6</sup> Lead in innovation and best practices.



## CAPITAL FUND - 2012 Capital Projects

---

**DEPARTMENT** CORPORATE SERVICES

**DIVISION** INFORMATION TECHNOLOGY

**PROJECT** Wireless Authentication / Authorization

**COST** \$25,000

**STATUS** New

**PHASE** 1 of 1

**DESCRIPTION** Wireless technologies have greatly expanded connectivity options and provided enhanced communications opportunities. The City has exploited these technologies for several years and although they were initially implemented as adjuncts to wired technology, they are rapidly becoming the primary method of connection for both staff and citizens.

As wireless connectivity continues to expand, it becomes increasingly important that the City implement progressively more sophisticated controls to streamline authorized access and prevent unauthorized – and potentially malicious or damaging – access. This project will see the implementation of a security appliance to provide central one-time log-on services that support site roaming, authentication management, and wireless device accounting.

This project works toward City Council's Goals #1<sup>1</sup> and #4<sup>2</sup>, Objectives #1.4<sup>3</sup> and #4.4<sup>4</sup>, and Action #4(b)<sup>5</sup>.

**O&M IMPACT** This project will not directly impact O&M expenditures, but will reduce the City's risk exposure.

- 
- <sup>1</sup> Affordability
  - <sup>2</sup> Create an environment of mutual respect, open dialogue, and team work.
  - <sup>3</sup> Emphasize fairness and transparency in financial decisions, program delivery and land assembly.
  - <sup>4</sup> Be a leader in innovation.
  - <sup>5</sup> Lead in innovation and best practices.

**CAPITAL FUND - 2012 Capital Projects**

---

**DEPARTMENT** CORPORATE SERVICES

**DIVISION** INFORMATION TECHNOLOGY

**PROJECT** Meeting Automation

**COST** \$100,000

**STATUS** New

**PHASE** 1 of 1

**DESCRIPTION** The City Clerk’s Office currently produces agendas, follow-ups and minutes for Council and Standing Committee meetings through Microsoft Word and Adobe Acrobat Standard. The agenda items are created within City Departments in Word and forwarded to the City Clerk’s Office for inclusion on the agendas. The current practice is to ‘cut and paste’ from the Memorandum to Committees to the Committee follow-up and minutes and then into the Council agenda and finally to the Council follow-up and minutes. These documents are then converted to PDF documents for distribution and inclusion on the City’s website. This has allowed the City to transition to paperless agendas and, although time has been saved from not having to photocopy everything, considerable time is still spent on compilation and distribution of the agendas and minutes.

This project proposes to automate this legislative process by utilizing software that will streamline the compilation and distribution of the agendas, post the agenda and minutes to the website, assist in recording of the minutes, taking roll, recording of motions and tallying votes and webcast the Committee and Council meetings. Through the use of templates, the software will automatically ‘cut and paste’ the essential information into follow-ups, minutes and subsequent agendas.

This software can also be used to assist the several other Committees of Council.

The entire project consists of:

**Agenda Software** To compile and create agendas, follow-ups and minutes and post to the website; record roll call; record motions; tally votes.

**Sound System** To assist with requesting to speak, recording of votes and for webcasting. (The current sound system is extremely old and the quality of the audio is inadequate for webcasting.)

**Video Software** To webcast meetings of Committee and Council. May also be used for community events such as election forums. Webcasts will be in a searchable format so that the public can quickly go to their topic of interest.

**Hardware** Smart Board and White Board to display motions and vote on motions, view PowerPoint presentations.

This project works toward City Council’s Goals and Objectives #1.4<sup>1</sup>, #3<sup>2</sup>, #3(b)<sup>3</sup>, #4<sup>4</sup>, #4.1<sup>5</sup>, #4.4<sup>6</sup>, #4(a)<sup>7</sup>, #4(b)<sup>8</sup>, #4(e)<sup>9</sup>.

**O&M IMPACT**

This project will increase the software maintenance budget by approximately 20% of the software acquisition cost.

(cont’d...)



(cont'd from previous page)

- 
- 1 Emphasize fairness and transparency in financial decisions, program delivery and land assembly.
  - 2 Building Social Capital (Community Engagement)
  - 3 Develop a Communication Plan to improve engagement with the community.
  - 4 Continuous Improvement
  - 5 Be accountable to residents by ensuring open and accessible information flow and accessible decision making.
  - 6 Be a leader in innovation.
  - 7 Develop a Customer Service Culture.
  - 8 Lead in innovation and best practices.
  - 9 Streamline Council's committee structure.



<b>DEPARTMENT</b>	<b>CORPORATE SERVICES</b>
<b>DIVISION</b>	<b>INFORMATION TECHNOLOGY</b>
<b>PROJECT</b>	<b>Development and Building Permit Automation</b>
<b>COST</b>	<b>2012 \$75,000</b> <b>2013 \$25,000</b>
<b>STATUS</b>	<b>New</b>
<b>PHASE</b>	<b>1 of 2</b>
<b>DESCRIPTION</b>	<p>The City's Planning and Development Department is seeking to automate the development and building permit process through the acquisition and deployment of plan review software. The software allows for applicants to electronically submit and pay for applications from home or work. The initiative reflects an increasing trend amongst municipalities toward automation of plan review to realize efficiencies, minimize paper waste, reduce physical file storage, and improve customer service.</p> <p>The department issues approximately 1,700 permits per year related to development and building applications. The current paper review process is cumbersome and inefficient as most permit applications require multiple paper plan submissions and reviews prior to approval. The paper review process prevents departments and external parties from reviewing and sharing comments concurrently and does not allow plan amendments and comments to be adequately tracked. Plan review software allows for the sharing of plans amongst various municipal divisions (i.e. Planning and Lands, Building Inspections, Fire and Ambulance Division, and Engineering) so that the review process can be streamlined and more interactive.</p>

The department has run out of filing room space for planning and building files and is currently paying to store plans offsite which adds both a financial and an administrative expense. The software allows plans to be stored digitally and viewed by staff members at their workstations to answer public enquiries and forward drawings via email. Customer service representatives will be better able to access the status of a permit review from the front counters, and the software will be integrated with existing financial software to support online payments and with the GIS to make information more readily available for staff and the public via cityExplorer. Implementing this software is essential to realizing the City's vision of One-Stop Shopping where service delivery to the public is streamlined and enhanced.

This project works toward City Council's Goals #1<sup>1</sup> and #4<sup>2</sup>, Objectives #1.4<sup>3</sup> and #4.4<sup>4</sup>, and Actions #4(a)<sup>5</sup> and #4(b)<sup>6</sup>.

**O&M IMPACT**

This project will increase software maintenance costs by approximately 20% of the software acquisition costs. However, it will also reduce paper and storage costs, and realize operational efficiencies.

- 
- 1 Affordability
  - 2 Continuous Improvement
  - 3 Emphasize fairness and transparency in financial decisions, program delivery and land assembly.
  - 4 Be a leader in innovation.
  - 5 Develop a Customer Service Culture.
  - 6 Lead in innovation and best practices.



## CAPITAL FUND - 2012 Capital Projects

---

**DEPARTMENT** CORPORATE SERVICES

**DIVISION** INFORMATION TECHNOLOGY

**PROJECT** Human Resources Process Automation

**COST** \$100,000

**STATUS** New

**PHASE** 1 of 1

**DESCRIPTION** Many Human Resources functions are currently paper-based. The associated forms are expensive to stock, handle, process, manage, and store. Considerable savings and efficiencies could be realized within the Human Resources Division and throughout the organization by automating the various processes and capturing data electronically at its source.

In 2011, Terms of Reference were developed for a Human Resources Automation initiative. In 2012, they will be refined into a statement of requirements that will form the basis for identifying and evaluating potential software solutions. It is anticipated that a suitable product will be selected early in the year, with acquisition, configuration, and implementation activities scheduled to achieve deployment by year-end.

This project works toward City Council's Goals #1<sup>1</sup> and #4<sup>2</sup>, Objectives #1.4<sup>3</sup> and #4.4<sup>4</sup>, and Action #4(b)<sup>5</sup>.

**O&M IMPACT** This project will increase software maintenance costs by approximately 20% of the application acquisition prices, but will streamline Human Resources-related functions throughout the organization.

- 
- 1 Affordability
  - 2 Continuous Improvement
  - 3 Emphasize fairness and transparency in financial decisions, program delivery and land assembly.
  - 4 Be a leader in innovation.
  - 5 Lead in innovation and best practices.

## CAPITAL FUND - 2012 Capital Projects

---

**DEPARTMENT** PUBLIC SAFETY  
**DIVISION** MUNICIPAL ENFORCEMENT  
**PROJECT** Status Keeping Software/GPS  
**COST** \$35,000  
**STATUS** New  
**PHASE** Ongoing

**DESCRIPTION** Status keeping is an enforcement/emergency service process where an external division or agency monitors the activities of enforcement/emergency personnel so as to minimize inherent risks associated with their duties.

For the Municipal Enforcement Division, the most common duties that require status keeping are traffic enforcement and attending higher risk calls such as loud parties or unruly patrons in City facilities. In the past, the RCMP provided status keeping for these types of duties, but no longer provide this service. For the last two years the Municipal Enforcement Division has had no status keeping capabilities.

To provide a safe working environment, the division has been forced to change its practices, such as doubling up officers in patrol cars. This practice has resulted in lower productivity and increased risk to the public through lower levels of enforcement.

In 2011, the division received approval to install laptop computers in each of the four patrol cars. This could give the division the ability to provide status keeping to its officers through a software package that allows them to electronically identify their location and activities which are then monitored electronically by an outside agency. This would once again allow officers to work

alone and perform their full duties during all hours of service. It would provide for a safer working environment and a much greater level of productivity than currently exists.

This project works toward City Council's Goals #1<sup>1</sup> and #4<sup>2</sup>, Objectives #1.4<sup>3</sup> and #4.4<sup>4</sup>, and Actions #4(a)<sup>5</sup> and #4(b)<sup>6</sup>.

### O&M IMPACT

There will be a monthly service charge from an outside monitoring agency. It is estimated that this will cost between \$100 and \$500 per month.

- 
- 1 Affordability
  - 2 Continuous Improvement
  - 3 Emphasize fairness and transparency in financial decisions, program delivery and land assembly.
  - 4 Be a leader in innovation.
  - 5 Develop a Customer Service Culture.
  - 6 Lead in innovation and best practices.



**CAPITAL FUND - 2012 Capital Projects**

	2010 Budget (\$000's)	2010 Actual (\$000's)	2011 Budget (\$000's)	2011 Forecast (\$000's)	2012 Budget (\$000's)	2013 Budget (\$000's)	2014 Budget (\$000's)
<b>Community Services</b>							
Arenas							
YKCA Upgrades	-	10	-	8	-	-	-
YKCA Upgrades - Dehumidifiers	-	-	-	-	75	-	-
YKCA Upgrades - Generator	-	-	125	125	-	-	-
YKCA Upgrade - Sprinkler System	-	-	-	-	100	-	-
YKCA Upgrade - Floor Replacement	-	-	-	-	35	-	-
YKCA Upgrades -Wiring	-	-	-	-	-	-	15
Multiplex Upgrade	-	18	-	-	-	-	-
Multiplex Emergency Backup Power System	150	1	-	-	-	-	-
Multiplex - Fall Protection	-	-	-	-	30	-	-
Multiplex Façade Repair	-	-	-	-	-	100	-
Multiplex - Snow Melt Pit	-	-	-	-	-	40	-
Multiplex - Painting DND Gymnasium & Lobby	-	-	-	-	-	60	-
Fieldhouse	11,663	7,497	-	44	-	-	-
Fieldhouse Maintenance Equipment	30	29	-	-	-	-	-
Fieldhouse Indoor Playground	100	86	-	14	-	-	-
Fieldhouse Floor Cover	-	-	30	30	-	-	-
YK Curling Club Upgrades	-	-	-	-	-	-	40
	<b>11,943</b>	<b>7,641</b>	<b>155</b>	<b>221</b>	<b>240</b>	<b>200</b>	<b>55</b>
Library							
Special Collection	-	6	-	-	-	-	-
Expansion / Renovations	-	13	-	45	-	-	-
	-	20	-	45	-	-	-

**CAPITAL FUND - 2012 Capital Projects**

	2010 Budget (\$000's)	2010 Actual (\$000's)	2011 Budget (\$000's)	2011 Forecast (\$000's)	2012 Budget (\$000's)	2013 Budget (\$000's)	2014 Budget (\$000's)
Parks/Trails							
Playground - Climbing Wall Installations	-	-	-	9	-	-	-
William MacDonald Track	50	8	-	-	-	-	-
Columbarium Park	-	-	-	-	75	-	-
Repair on McMahon Frame Lake Trail	-	-	50	10	-	-	-
Sculpture Installation	-	14	-	-	-	-	-
Litter Containers	-	34	-	-	-	-	-
Lakeview Cemetery Expansion	-	-	-	-	-	100	-
Fencing - Cemetery and Ballparks	-	-	-	-	-	100	-
Playground Equipment Replacement	-	-	90	91	115	90	-
Relocation of Olexin Park Playground	-	-	28	7	-	-	-
Fritz Theil Upgrade	-	-	-	-	64	-	-
Ball Diamond Upgrade	-	-	-	-	-	-	25
Rental Equipment	-	-	-	-	32	-	40
Sport & Multi-use Fields Upgrade	-	-	-	-	100	130	160
Outdoor Fitness Equipment	-	-	-	-	-	-	75
Trail Development - Old Airport Road, McMahon Frame Lake & Tin Can Hill	-	-	-	-	-	400	290
Yellowknife Rotary Park - Trail Extension	-	-	-	-	-	80	-
Yellowknife Rotary Waterfront Park	25	-	-	-	-	-	-
Twin Pine Hill Trail Development	-	-	50	-	350	150	-
Park and Trail Development - Niven Subdivision	-	-	70	58	-	-	-
Paving - Niven Lake Trail	-	-	-	-	-	-	255
Civic Plaza/Somba K'e Park/ Library Site Design and Development	240	470	-	148	-	-	-
	315	525	288	323	736	1,050	845



**CAPITAL FUND - 2012 Capital Projects**

	2010 Budget (\$000's)	2010 Actual (\$000's)	2011 Budget (\$000's)	2011 Forecast (\$000's)	2012 Budget (\$000's)	2013 Budget (\$000's)	2014 Budget (\$000's)
<b>Pool</b>							
Engineer Mid-Life Study and Facility Upgrades	30	28	-	-	-	-	-
Heat Recovery Ventilator Retrofit	25	17	-	-	-	-	-
Replacement of Façade	-	56	-	-	-	-	-
Security Improvement to Pool Reception & Changing Area	-	75	-	-	-	-	-
Exit Vestibule	-	17	-	-	-	-	-
Replacement of Air Handling Unit	-	-	210	210	-	-	-
Deck Repair	-	-	25	13	-	-	-
Air Conditioning	-	-	45	34	-	-	-
Pool Upgrade	-	-	-	-	150	80	200
	55	194	280	257	150	80	200
<b>Wildcat Café</b>							
Wildcat Café Repair - Foundation	-	4	-	-	-	-	-
Structural Repair	-	-	385	525	-	-	-
<b>City Hall</b>							
Air Handling Unit Replacement	150	116	-	64	-	-	-
Stairs	30	-	-	-	-	-	-
Roof Replacement	-	-	355	-	100	-	-
Generator Replacement	-	-	125	125	-	-	-
Renovation Study	-	-	50	200	-	-	-
Boiler Replacement	-	-	-	-	200	-	-
	180	120	915	914	300	-	-
<b>Total</b>	<b>12,493</b>	<b>8,499</b>	<b>1,638</b>	<b>1,759</b>	<b>1,426</b>	<b>1,330</b>	<b>1,100</b>

**CAPITAL FUND - 2012 Capital Projects**

		2012 Budget Recommended (\$000s)	Formula Funding (\$000s)	Other Revenue (\$000s)	Grants (\$000s)	Twin Pine Hill Trail Reserve (\$000s)
<b>Community Services</b>						
	<u>Page</u>					
<b>Arenas</b>						
YKCA Upgrade - Dehumidifiers	231	75	75			
YKCA Upgrade - Sprinkler System	232	100	100			
YKCA Upgrade - Floor Replacement	233	35	35			
Multiplex - Fall Protection	234	30	30			
<b>Parks/Trails</b>						
Columbarium Park	235	75	75			
Playground Equipment Replacement -Lamoureux Park	236	30	30			
Playground Equipment Replacement - Somba K'e Playground	237	85	5		80	
Fritz Theil Upgrade	238	64	44	20		
Rental Equipment	239	32	32			
Sport & Multi-use Fields Upgrade- St. Joseph School Field	240	100	100			
Twin Pine Hill Trail Development	241	350		175		175
<b>Pool</b>						
Upgrades - Replacment of Air Handling Unit #2	242	150	150			
<b>City Hall</b>						
Roof Replacement	243	100	100			
Boiler Replacement	244	200	200			
<b>Subtotal</b>		<u>1,426</u>	<u>976</u>	<u>195</u>	<u>80</u>	<u>175</u>



## CAPITAL FUND - 2012 Capital Projects

---

<b>DEPARTMENT</b>	<b>COMMUNITY SERVICES</b>
<b>DIVISION</b>	<b>FACILITIES</b>
<b>PROJECT</b>	<b>Yellowknife Community Arena - Dehumidifiers</b>
<b>COST</b>	<b>\$75,000</b>
<b>STATUS</b>	<b>Replacement</b>
<b>PHASE</b>	<b>1 of 1</b>
<b>DESCRIPTION</b>	<p>The Yellowknife Community Arena was built in 1982. Since that time, the arena has utilized two Humicon dehumidification units to reduce humidity over the ice surface. The existing equipment has reached its full life expectancy and one unit does not work. Repairs are no longer feasible and it will need to be replaced.</p> <p>If the units are not replaced, mould will soon develop, causing degradation of the building's interior metal components (plumbing, structural steel, and electronics).</p> <p>The dehumidifiers that are being proposed will be more energy-efficient than the current 27-year-old units utilizing up-to-date technology.</p> <p>This project works toward Council's Goal # 2<sup>1</sup>.</p>
<b>O&amp;M IMPACT</b>	Little or no O&M impact above the normal operating budget.

---

<sup>1</sup> Enhancing our built environment



## CAPITAL FUND - 2012 Capital Projects

---

**DEPARTMENT** COMMUNITY SERVICES  
**DIVISION** FACILITIES  
**PROJECT** Yellowknife Community Arena - Sprinkler System  
**COST** \$100,000  
**STATUS** Upgrade  
**PHASE** 1 of 1

**DESCRIPTION** The sprinkler system in use at the Yellowknife Community Arena was installed in 1982, 29 years ago. The installation of the low emissivity roofing has placed the roofing too close to the sprinklers. This was identified as a potential issue with the operation of the sprinkler system, in a recent report completed by A.D. Williams.

The original installation has been an issue since the facility opened. The sprinkler does not drain back to the sprinkler tree, therefore additional drains were installed causing the system to freeze and break on occasions. The proposal is to lower the heads, which will address both issues.

This project works toward Council's Goal # 2<sup>1</sup>.

**O&M IMPACT** There is no O&M impact.



---

<sup>1</sup> Enhancing our built environment.



## CAPITAL FUND - 2012 Capital Projects

---

<b>DEPARTMENT</b>	<b>COMMUNITY SERVICES</b>
<b>DIVISION</b>	<b>FACILITIES</b>
<b>PROJECT</b>	<b>Yellowknife Community Arena - Floor Replacement (Lobby and Downstairs)</b>
<b>COST</b>	<b>\$35,000</b>
<b>STATUS</b>	<b>Replacement</b>
<b>PHASE</b>	<b>1 of 1</b>
<b>DESCRIPTION</b>	The Community Arena was built in 1982 and has served the needs of the community very well over the years. Ten different user groups consisting of over 1,000 members have been using this facility for 40 hours per week, 30 weeks per year over the past 29 winters, including four Arctic Winter Games. The facility has also hosted countless concerts, bingos, trade shows, dry graduations, and other special events throughout the spring and summer months.

The project being proposed is to replace the existing floor tiles in the main lobby, as well as the skate tile in the skate lobby and dressing room areas.

### Main Lobby

Replace flooring in the main lobby, washrooms and office. The existing floor is worn out with mix-and-match tiles from previous repairs that are beginning to chip.

The floor is also hazardous, as it becomes slippery when wet. Tiles are in continual need of replacement as they chip and break due to age. The proposed replacement floor will be a recycled rubber skate tile.

### Downstairs Flooring

Replace flooring in the downstairs lobby dressing rooms and entrances to the arena floor. The existing floor is

worn out in the high traffic areas with high maintenance needs. The skate tile was last replaced in 1996 and it has met its full life expectancy. The proposed replacement floor is a recycled rubber skate tile.

### Replacement

It is proposed that the flooring be replaced with a flooring material that is 100% solid rubber and made to withstand heavy weight and traffic.

The material will be a non-slip textured finish combined with a solid colour and marbled accents. This is ideal for durability and safety.

Project works toward Council's Goal #2<sup>1</sup>.

**O&M IMPACT** There is no direct O&M impact.



---

<sup>1</sup> Enhancing our built environment

## CAPITAL FUND - 2012 Capital Projects

---

**DEPARTMENT** COMMUNITY SERVICES

**DIVISION** FACILITIES

**PROJECT** Multiplex - Fall Protection

**COST** \$30,000

**STATUS** New

**PHASE** 1 of 1

**DESCRIPTION** Currently, there is no fall protection system for the Multiplex Facility. As a result, staff are unable to access the roof to repair mechanical systems or undertake other necessary maintenance functions.

The Workers' Safety and Compensation Commission (WSCC) administers and enforces the Safety Act and the Regulations within the Northwest Territories. The Safety Regulations require that an employer provide fall protection to all workers working at heights equal to or greater than 10 feet (3m).

A fall protection system in conjunction with a fall protection plan will provide City employees a safe workplace while performing tasks such as routine and preventative maintenance of air handling units, exhaust fans and roof, removing excess snow, maintaining IT equipment, etc.

This meets Council's Goal #2<sup>1</sup>.

**O&M IMPACT** There will be no direct impact on the O&M.

---

<sup>1</sup> Enhancing our built environment.



## CAPITAL FUND - 2012 Capital Projects

---

**DEPARTMENT** COMMUNITY SERVICES

**DIVISION** FACILITIES

**PROJECT** Columbarium Park

**COST** \$75,000

**STATUS** New

**PHASE** 1 of 1

**DESCRIPTION** The City has received input indicating that there is a desire for the development of a Columbarium Park for cremated remains. Currently, the Lakeview Cemetery allows burials in the ground in either a grave plot for a casket or a smaller grave plot for cremated remains. The space in the cemetery is currently at a premium, and, with the request for choice as well as the space limitations we are experiencing, it is a good time to investigate alternative methods of burial.

It is proposed that a Columbarium Park be erected at the Lakeview Cemetery. This aesthetically pleasing park will provide a place for quiet reflection and will have columbaria for the interment of cremated human remains above ground in a monument-type installation. The installation can use land that is otherwise inappropriate for burials as well as providing citizens with an alternative to ground burials.

This works toward Council's Goal #2<sup>1</sup>.

**O&M IMPACT** The Columbarium Park will require daily maintenance, \$1,000 per year for materials, and \$4,000 per year in staff time. A portion of these costs will be offset by revenue generated by plot sales.

---

<sup>1</sup> Enhancing our built environment.

## CAPITAL FUND - 2012 Capital Projects

---

DEPARTMENT COMMUNITY SERVICES  
DIVISION FACILITIES  
PROJECT Playground Equipment Replacement  
Cost \$115,000  
Budget Lamoureux \$30,000  
Somba K'e \$85,000  
Less Grant (\$80,000)  
Total \$35,000  
STATUS Replacement  
PHASE Ongoing

DESCRIPTION Playgrounds have a life span of about 15 to 20 years and need to be replaced on an ongoing basis to serve the community.

There have been multiple code changes and advances in play equipment over the past 20 years, and the new equipment is mostly hard plastic that endures well in our northern climate. It is now recommended by suppliers that all new playground equipment be erected with plastics/powder coated aluminum technologies.

### Lamoureux Park

In 2012, it is proposed that the playground equipment be replaced at Lamoureux Park. The equipment is a combination of steel and wooden structures that have deteriorated over the years. The equipment is used frequently by many citizens in the area.

The new playground equipment will stimulate children and encourage their mental and physical growth. This is an investment in the future of Yellowknife, and works toward Council's Goal #2<sup>1</sup>.



**Somba K'e Park**

The Somba K'e playground is located in an area that is susceptible to vandalism and provides limited views from the road and surrounding buildings. This area has grown and will continue to grow in use by the residents of Yellowknife. Currently, there is no play area for children in the Civic Plaza, and this project would allow for the relocation of the Somba K'e playground to a more open area that will provide better views and reduce vandalism. It is proposed to move the new playground to an open area just beside the Community Services building in the park.

In conjunction with the move, there will be a replacement and upgrade of some of the existing playground equipment.

This meets Council's Goal #2<sup>2</sup>.



**O&M IMPACT**

There will be no financial impact as this playground already exists and will require the same level of safety checks and maintenance, regardless of the age of the equipment.

---

<sup>1, 2</sup> Enhancing our built environment.

**CAPITAL FUND - 2012 Capital Projects**

---

<b>DEPARTMENT</b>	<b>COMMUNITY SERVICES</b>	
<b>DIVISION</b>	<b>FACILITIES</b>	
<b>PROJECT</b>	<b>Fritz Theil Upgrade</b>	
<b>COST</b>	Ball Field Concession	<b>\$40,000</b>
	Field Upgrade	<u><b>\$24,000</b></u>
		<b>\$64,000</b>
<b>STATUS</b>	<b>New</b>	
<b>PHASE</b>	<b>1 of 1</b>	
<b>DESCRIPTION</b>	<b>Fritz Theil Ball Park Concession Building - \$40,000</b>	
	<p>The concession building in Fritz Theil Ball Park was identified in the Infrastructure Needs Assessment as being in need of immediate maintenance. Previously, the concession was covered under the agreement with the Yellowknife Slo-Pitch Association but, over the years and with a changing executive, the building became neglected as it was not meeting the needs of the Yellowknife Slo-Pitch Association in the location where it had been built.</p> <p>Eventually, the building deteriorated to the point where it was a health and safety hazard, and the facility was demolished in 2009.</p> <p>The Slo-Pitch Association has agreed to cost-share the project by providing 50% funding to develop a new facility in an area which is more favourable to the operations of the association.</p> <p>The new concession building will measure 24 X 20 feet and will include a canteen area, men's and women's washrooms, a wheelchair accessible washroom, storage, and umpire rooms.</p>	

This project works toward Council's Objective #3.2<sup>1</sup>.

**Budget**

Concession Replacement	<b>\$40,000</b>
Less Slo-Pitch Association Contribution	<u><b>\$20,000</b></u>
<b>Total Cost to City of Yellowknife</b>	<b>\$20,000</b>

**Fritz Theil Field Upgrade - \$24,000**

This field is the only large green space available to residents in the surrounding areas, and the field is used by the Ultimate Frisbee Association and other community groups on an ad hoc basis. To increase use of the field, there is a need to remove boulders, level the field, and expand it by moving the fence.

Once the renovations are completed, organized groups (e.g. Ultimate) using the field will be subject to user fee rates.

This project works toward Council's Objective #3.2<sup>1</sup>.

**O&M IMPACT**

There will be no O&M impact for the Concession Building as the Yellowknife Slo-Pitch Association will assume responsibility for the facility under an agreement with the City.

The field is currently maintained to a Class 'B' standard. By upgrading to a usable sports field, the maintenance will increase as will the revenue generated through field rentals.

---

<sup>1</sup> Improve quality of life by promoting healthy and active lifestyle choices.



**CAPITAL FUND - 2012 Capital Projects**

---

**DEPARTMENT**    **COMMUNITY SERVICES**

**DIVISION**        **FACILITIES**

**PROJECT**         **Rental Equipment**

**COST**             **\$72,000**

<b>BUDGET</b>	<u><b>2012</b></u>		<u><b>2014</b></u>	
	Parks	\$15,000	Parks	\$15,000
	Fieldhouse	<u>\$17,000</u>	Fieldhouse	<u>\$25,000</u>
	<b>Total =</b>	<b>\$32,000</b>	<b>Total =</b>	<b>\$40,000</b>

**STATUS**          **New**

**PHASE**          **2012    1 of 2**  
**2014    2 of 2**

**DESCRIPTION**    The department makes tables and chairs available for a fee when renting out the arenas, parks and Fieldhouse for various events. Rental of these items generates approximately \$60,000 annually for the City, under the provisions of the Fees and Charges By-law.

Due to heavy use, the equipment requires ongoing replacement, and it is proposed to replace and enhance our inventory by adding tables and chairs to both the parks and Fieldhouse inventories over the next two years.

<u><b>2012</b></u>	
100 tables	\$12,860
490 chairs	<u>\$19,140</u>
<b>Total =</b>	<b>\$32,000</b>

<u><b>2014</b></u>	
120 tables	\$18,100
500 chairs	<u>\$20,150</u>
<b>Total =</b>	<b>\$40,000</b>

This project meets Council's Goal #2<sup>1</sup>.

**O&M IMPACT**    There will be no additional cost for maintenance as this will be covered under our current budget for repairs and maintenance.

---

<sup>1</sup> Enhancing our built environment.



## CAPITAL FUND - 2012 Capital Projects

---

<b>DEPARTMENT</b>	<b>COMMUNITY SERVICES</b>		
<b>DIVISION</b>	<b>FACILITIES</b>		
<b>PROJECT</b>	<b>Sport &amp; Multi-Use Fields Upgrade</b>		
<b>COST</b>	<b>2012</b>	<b>St. Joseph School Field</b>	<b>\$100,000</b>
	<b>2013</b>	<b>William McDonald School Field</b>	<b>\$130,000</b>
	<b>2014</b>	<b>Range Lake North School Field</b>	<b>\$100,000</b>
	<b>2014</b>	<b>Sir John Franklin School Field</b>	<b>\$60,000</b>
<b>STATUS</b>	<b>Upgrade</b>		
<b>PHASE</b>	<b>2012</b>	<b>1 of 3</b>	
	<b>2013</b>	<b>2 of 3</b>	
	<b>2014</b>	<b>3 of 3</b>	

**DESCRIPTION** The Facilities Division currently maintains two sport fields (Range Lake North and William McDonald schools) where residents play organized soccer and rugby, and two multi-use fields (St. Joseph and Sir John Franklin schools) for general community use.

As the two sport fields are used to capacity, there is little time to perform the required maintenance, especially when work cannot begin until after the schools are closed for the summer months.

By staggering work on the fields over a three-year period, there will be minimal disruption to the user groups, as only one field per annum will be retrofitted. With the use of the sod on the fields it is projected that they will be out of service for no longer than a month at a time.

It is proposed that, in 2012, St. Joseph School's field be the first to be retrofitted. The field would be adjusted to accommodate minimum requirements for a soccer pitch, thereby allowing for work on William McDonald Middle School's field in 2013. The field at William

McDonald School would include an extension of the field and track, thereby enlarging both facility areas. The final two fields (Range Lake North and Sir John Franklin schools) will be completed in 2014.

This project works toward Council's Goal #3<sup>1</sup>.

**O&M IMPACT** There will be no additional costs for maintenance as this will be covered under our current budget for repairs and maintenance.

---

<sup>1</sup> Enhancing our built environment



**CAPITAL FUND - 2012 Capital Projects**

---

**DEPARTMENT**    **COMMUNITY SERVICES**

**DIVISION**        **PARKS**

**PROJECT**         **Twin Pine Hill Trail Development**

**COST**

2011 Carry over	\$ 50,000
2012	\$350,000
2013	<u>\$150,000</u>
<b>Total</b>	<b>\$550,000</b>

**BUDGET**         **Cost will be covered by the Twin Pine Hill Trail Reserve and funding from Deton Cho Corporation.**

Twin Pine Hill Trail Reserve	\$260,000
Deton Cho Corporation	\$250,000
Capital Fund	<u>\$ 40,000</u>
<b>Total</b>	<b>\$550,000</b>

**STATUS**           **New**

**PHASE**

2011	1 of 3
2012	2 of 3
2013	3 of 3

**DESCRIPTION**    The City of Yellowknife has entered into a Development Agreement with Yellowknife River Resources Inc. (YRRI) for the development of Twin Pine Hill (YRRI is now bought out by Deton Cho Corporation).

The Agreement stipulates that Yellowknife River Resources Inc. will pay one-half of the costs of planning and constructing a trail system on City-owned land to a maximum of \$250,000.

It is proposed that in 2012, the consultation, planning, and development process be carried out and the first phase of the trail development be undertaken. In 2012 and 2013, the actual trail development will be completed over a two-year period.

This project works toward City Council's Goal #2<sup>1</sup>.

**O&M IMPACT**    The development of trails and parks on Twin Pine Hill will result in the allocation of staff and materials. Construction of these trails, commencing 2012 and ending 2013, will affect the 2014 O&M budget.

Increases are generally of the following magnitude:

- \$160/tree planted
- \$3.20/sq. m of trail developed
- \$3.00/sq. m of Class A green space developed

---

<sup>1</sup> Enhancing our built environment

## CAPITAL FUND - 2012 Capital Projects

---

<b>DEPARTMENT</b>	<b>COMMUNITY SERVICES</b>
<b>DIVISION</b>	<b>PROGRAMS</b>
<b>PROJECT</b>	<b>Replacement of Air Handling Unit #2</b>
<b>COST</b>	<b>\$150,000</b>
<b>STATUS</b>	<b>Replacement</b>
<b>PHASE</b>	<b>1 of 1</b>
<b>DESCRIPTION</b>	<p>The City of Yellowknife contracted an engineering firm in 2010 to do a mid-life cycle analysis of the Ruth Inch Memorial Pool to address life cycle issues that will ensure the longevity of the facility.</p> <p>The air handling system was identified as one of the priorities that needed to be addressed immediately in the next one to three years.</p> <p>The Pool operates two air handling unit systems; the main one was identified to be replaced in 2011 and the smaller unit to be replaced in 2012. The smaller unit provides air to the windows and the entrance and outer offices of the pool.</p> <p>The study will prioritize and provide a cost breakdown to plan for future life cycle upgrades of the Ruth Inch Memorial Pool.</p> <p>This project works toward Council's Goal #3<sup>1</sup>.</p>
<b>O&amp;M IMPACT</b>	No immediate impact on O&M Budget.

---

<sup>1</sup> Building Social Capital (Community Engagement).



## CAPITAL FUND - 2012 Capital Projects

---

**DEPARTMENT** COMMUNITY SERVICES

**DIVISION** FACILITIES

**PROJECT** City Hall – Roof Replacement

<b>COST</b>	2011	Carry Over	\$355,000
	2012	Budget	<u>\$100,000</u>
	<b>Total</b>		<b>\$455,000</b>

**STATUS** Replacement

**PHASE** 1 of 1

**DESCRIPTION** City Hall was built in 1975 as the administrative centre of the City of Yellowknife. Since that time, there have been very few upgrades to the structural components of the building. The roof at City Hall dates from the building's original construction in 1975. In the past few years, the roof has begun to leak, and it needs to be replaced before major damage occurs to the structure of the building.

It is proposed to remove and dispose of the ballast, existing roofing, and insulation from this area. A vapor barrier, R40 insulation, plywood deck, and 2-ply roofing will be installed.

This project works toward Council's Goal #2<sup>1</sup>.

**O&M IMPACT** There will be no direct impact on O&M; however, this project will allow current resources to be directed to other priorities.

---

<sup>1</sup> Enhancing our built environment

## CAPITAL FUND - 2012 Capital Projects

---

**DEPARTMENT** COMMUNITY SERVICES

**DIVISION** FACILITIES

**PROJECT** City Hall – Boiler Replacement

**COST** \$200,000

**STATUS** Replacement

**PHASE** 1 of 1

**DESCRIPTION** City Hall was built in 1975 to serve as the administrative centre of the City of Yellowknife. The boiler in the building was originally installed in 1975, 36 years ago. Boilers are normally replaced after 20 years of service.

While the existing boiler has served the City well, it is old and has exceeded its life expectancy. Parts for this boiler are becoming difficult to source, therefore ongoing maintenance has become an issue.

This project works toward Council's Goal #2<sup>1</sup>.

**O&M IMPACT** There will be no financial impact as a boiler already exists and will require the same level of safety checking regardless of the age of the equipment.

---

<sup>1</sup> Enhancing our built environment.



**CAPITAL FUND - 2012 Capital Projects**

	2010 Budget (\$000's)	2010 Actual (\$000's)	2011 Budget (\$000's)	2011 Forecast (\$000's)	2012 Budget (\$000's)	2013 Budget (\$000's)	2014 Budget (\$000's)
<b>Public Safety</b>							
Directorate							
Emergency Supplies	-	-	-	-	15	-	-
Municipal Enforcement							
Replacement of Parking Meter Mechanisms	-	-	270	270	-	-	-
Office Furniture Replacement	-	-	12	11	-	-	-
	-	-	282	281	15	-	-
Fire & Ambulance							
Rescue Equipment Upgrade	-	21	-	-	-	-	-
Storage Facility	-	-	-	-	-	-	150
Self-Contained Breathing Apparatus	50	67	50	50	-	-	-
Fire Hall Drainage System	-	11	-	-	-	-	-
Fire Hall Expansion	-	-	650	859	-	-	-
Air Exhaust - Apparatus Bay	100	96	-	-	-	-	-
Bunker Gear / Safety Compliant Equipment	18	59	20	20	-	-	-
Bunker Gear Lockers	-	-	-	-	-	60	-
Smoke House Demolition	-	-	-	4	-	-	-
Front Ramps and Site Improvement	-	-	150	-	-	150	-
Zodiac Boat & Motor	-	-	20	20	-	-	-
Installation of Training Hydrant	-	-	-	-	110	-	-
Pavement for NE Side of Ramp	-	-	-	-	40	-	-
Mechanical Controls (Heat & Air Make Up)	-	-	-	-	25	-	-
Training Equipment for Firefighter Workouts	-	-	20	20	-	-	-
Live Fire Training Structure	-	-	50	145	-	-	-
Thermal Imaging Cameras	-	-	-	-	-	-	25
FDM Software (Apparatus Maintenance Module)	-	-	-	-	-	-	30
	168	254	960	1,119	175	210	205

## CAPITAL FUND - 2012 Capital Projects

---

		<b>2012 Budget Recommended (\$000s)</b>	<b>Formula Funding (\$000s)</b>
<b>Public Safety</b>			
	<b><u>Page</u></b>		
<b>Directorate</b>			
Emergency Supplies	247	15	15
<b>Fire &amp; Ambulance</b>			
Installation of Training Hydrant	248	110	110
Paving of Northeast Side of Ramp	249	40	40
Mechanical Controls (Heat & Air Make Up)	250	25	25
<b>Subtotal</b>		<b><u>190</u></b>	<b><u>190</u></b>



## CAPITAL FUND - 2012 Capital Projects

---

<b>DEPARTMENT</b>	<b>PUBLIC SAFETY</b>
<b>DIVISION</b>	<b>EMERGENCY OPERATIONS</b>
<b>PROJECT</b>	<b>Emergency Supplies – Two Sea-Cans with folding cots and blankets</b>
<b>COST</b>	<b>\$15,000 (with matching funding from the Joint Emergency Preparedness Program, total cost \$30,000)</b>
<b>STATUS</b>	<b>New</b>
<b>PHASE</b>	<b>Phase 1 of 1</b>
<b>DESCRIPTION</b>	<p>This purchase will be for two 20-foot Sea-Cans that can be equipped with a base for transport by utilizing either a City-operated loader or the City-operated roll-off truck. Both Sea-Cans will be filled with blankets and folding, easily cleaned cots (to be steam-cleaned after use) for emergency situations (e.g. reception centre for other communities, or for our own residents in the event of a prolonged power outage at extreme winter temperatures.)</p> <p>As the project qualifies for funding from the federal Joint Emergency Preparedness Program, the City is budgeting \$15,000 with the expectation that an additional \$15,000 will be provided by the territorial department of Municipal and Community Affairs which administers the program in the NWT.</p> <p>This project works toward City Council's Goal #4<sup>1</sup>.</p>
<b>O&amp;M IMPACT</b>	Minimal, only utilized during emergency operations. Staff resources would be required if moving the storage units.

---

<sup>1</sup> Continuous improvement



## CAPITAL FUND - 2012 Capital Projects

---

<b>DEPARTMENT</b>	<b>PUBLIC SAFETY</b>
<b>DIVISION</b>	<b>FIRE AND AMBULANCE</b>
<b>PROJECT</b>	<b>Installation of Training Hydrant</b>
<b>COST</b>	<b>\$110,000</b>
<b>STATUS</b>	<b>New</b>
<b>PHASE</b>	<b>1 of 1</b>
<b>DESCRIPTION</b>	To install an additional hydrant in close proximity to the burn structure in order to enhance training initiatives for staff and assist in meeting OH&S requirements.  This project works toward City Council's Goal #4 <sup>1</sup>
<b>O&amp;M IMPACT</b>	Minimal

---

<sup>1</sup> Continuous Improvement.



## CAPITAL FUND - 2012 Capital Projects

---

**DEPARTMENT** PUBLIC SAFETY  
**DIVISION** FIRE AND AMBULANCE  
**PROJECT** Paving of Northeast Side of Ramp  
**COST** \$40,000  
**STATUS** New  
**PHASE** 1 of 1  
**DESCRIPTION** To increase parking areas and alleviate drainage issues during training exercises.  
This project works toward City Council's Goal #2<sup>1</sup>.  
**O&M IMPACT** Minimal

---

<sup>1</sup> Enhancing our Built Environment.

## CAPITAL FUND - 2012 Capital Projects

---

<b>DEPARTMENT</b>	<b>PUBLIC SAFETY</b>
<b>DIVISION</b>	<b>FIRE AND AMBULANCE</b>
<b>PROJECT</b>	<b>Mechanical Controls (Heat and Air Make Up)</b>
<b>COST</b>	<b>\$25,000</b>
<b>STATUS</b>	<b>Replacement</b>
<b>PHASE</b>	<b>1 of 1</b>
<b>DESCRIPTION</b>	<p>The Fire Division has an older system which controls our heat and air supply system to the building. This system is very labour-intensive to maintain and it is difficult to find parts to repair it when necessary. Currently, the building goes from one extreme to the other: too warm, or too cold.</p> <p>This project works toward City Council's Goal #2<sup>1</sup>.</p>
<b>O&amp;M IMPACT</b>	Minimal

---

<sup>1</sup> Enhancing Our Built Environment



**CAPITAL FUND - 2012 Capital Projects**

	2010 Budget (\$000's)	2010 Actual (\$000's)	2011 Budget (\$000's)	2011 Forecast (\$000's)	2012 Budget (\$000's)	2013 Budget (\$000's)	2014 Budget (\$000's)
<b>Planning &amp; Development</b>							
Housing & Affordability Strategy/ Eco Housing	-	-	-	95	-	-	-
Yellowknife Smart Growth Redevelopment Plan	-	93	-	20	-	-	-
Old Airport Road / Franklin Ave. Streetscaping	500	245	-	449	-	-	-
50th Street Streetscaping	-	-	-	40	-	-	-
Smart Growth & Harbour Plan Initiatives	-	5	500	500	500	600	1,000
Streetscaping Initiatives	-	-	450	981	500	500	500
	500	343	950	2,085	1,000	1,100	1,500

	<b>Page</b>	<b>2012 Budget Recommended (\$000s)</b>	<b>MACA Capital Grant (\$000s)</b>
<b>Planning &amp; Development</b>			
Smart Growth & Harbour Plan Initiatives	252	500	500
Streetscaping Initiatives (Old Airport Rd)	253	500	500
<b>Subtotal</b>		<b>1,000</b>	<b>1,000</b>

## CAPITAL FUND - 2012 Capital Projects

---

**DEPARTMENT** PLANNING AND DEVELOPMENT

**DIVISION** PLANNING AND LANDS

**PROJECT** Smart Growth and Harbour Plan Initiatives

**COST**

2012	\$500,000
2013	\$600,000
2014	\$1,000,000

**STATUS** Ongoing

**DESCRIPTION** In 2010, City Council adopted the Smart Growth Development Plan for information, and the Smart Growth Implementation Committee was appointed in 2011. In 2011, the Harbour Plan was also presented for adoption. Both plans have a series of recommendations which include initiatives that have attracted interest from federal funding agencies. Such projects include:

- Streetscaping/active transportation on Old Airport Road;
- Eco-Housing Initiative;
- Harbourfront public access nodes;
- 50/50 Centre Square Plaza; and
- Hudson's Bay building restoration.

For 2012, the department is projected to acquire between \$1 and \$2 million in funding grants which will require a combination of matching and in-kind funds. It is estimated that \$500,000 should be sufficient to cover the City's funding requirements and to target the various Smart Growth and Harbour Plan initiatives which are most beneficial to the City.

Administration has had preliminary engagement with various private sector and public interests on these various initiatives and is confident that partnerships can be arranged to leverage additional resources. Based on input from the committee, the most beneficial projects will be pursued in 2012.

In addition to the goals and objectives of the Downtown Plan, Harbour Plan, General Plan, and the Smart Growth Development Plan, the project achieves Council's Goals #2<sup>1</sup>, #3<sup>2</sup>, and #4<sup>3</sup>.

**O&M IMPACT:** Undefined

---

<sup>1</sup> Enhancing our Built Environment

<sup>2</sup> Building Social Capital (Community Engagement)

<sup>3</sup> Continuous Improvement



**CAPITAL FUND - 2012 Capital Projects**

---

<b>DEPARTMENT</b>	<b>PLANNING AND DEVELOPMENT</b>	<b>O&amp;M IMPACT</b>	Some operational impacts on Community Services for landscape maintenance will come into effect after the three-year maintenance guarantee of the contractor expires. These costs will be partially mitigated through the design and offset through additional reinvestment and revitalization of the Old Airport Road Corridor from the private sector.
<b>DIVISION</b>	<b>PLANNING AND LANDS</b>		
<b>PROJECT</b>	<b>Streetscaping Initiatives</b>		
<b>COST</b>	2012 \$500,000 (Old Airport Road) 2013 \$500,000 (Downtown) 2014 \$500,000 (Downtown)		
<b>STATUS</b>	Ongoing		
<b>PHASE</b>	1 of 1		
<b>DESCRIPTION</b>	<p>In 2010-11, the City received \$980,000 from CanNor's Community Adjustment Fund to undertake Phase 1 of the Old Airport Road streetscape initiative. Phase 1 included the area in front of Staples and the Frame Lake Capital Area as well as the entranceway to Old Airport Road from Highway #3 to the Cemetery Road. In 2011, Phase 2 was undertaken to address the outstanding drainage issues in front of and behind Stanton Plaza and to improve active transportation linkages from Borden Drive to the Co-op and Frame Lake. Detailed construction design of Phase 3 (Final Stage), from Borden Drive to Byrne Road including Range Lake trail linkage from Range Lake Road to Old Airport Road, was also undertaken in 2011 in consultation with the adjacent property owners. This link is essential to the completion of this initiative by providing safe and continuous pedestrian/cycling access to businesses along the corridor while also addressing drainage, vehicular access, and streetscape beautification.</p> <p>In addition to the goals and objectives of the Downtown Plan, General Plan, and Smart Growth Development Plan, the project achieves Council's Goals #2<sup>1</sup>, #3<sup>2</sup>, and #4<sup>3</sup>.</p>		

---

<sup>1</sup> Enhancing our Built Environment  
<sup>2</sup> Building Social Capital (Community Engagement)  
<sup>3</sup> Continuous Improvement

**CAPITAL FUND - 2012 Capital Projects**

	2010 Budget (\$000's)	2010 Actual (\$000's)	2011 Budget (\$000's)	2011 Forecast (\$000's)	2012 Budget (\$000's)	2013 Budget (\$000's)	2014 Budget (\$000's)
<b>Public Works &amp; Engineering</b>							
Fleet Replacement	1,254	872	1,259	1,206	1,449	1,005	1,067
	1,254	872	1,259	1,206	1,449	1,005	1,067
Engineering & Garage							
New Parking - Garage	-	-	750	-	150	-	-
Diagnostic, Safety Equipment & Specialty Tools For Mechanics	15	9	15	21	20	20	-
Management Operating System	145	144	-	-	-	-	-
Survey Equipment & AutoCad Software	-	-	75	75	-	-	-
Garage - Fire Code & Safety Improvements	100	90	100	110	50	50	50
	260	244	940	206	220	70	50
Roads & Sidewalks							
Road Rehabilitation	1,525	1,542	2,805	2,805	700	2,622	3,500
Transit Funding - Pedestrian Walkways	-	49	-	-	-	-	-
Transit Funding - Multi-purpose Highway Crossing Hwy #4	-	10	-	-	-	-	-
Franklin Ave./Old Airport Road Traffic Lights Upgrade	105	53	-	167	-	-	-
Traffic Lights UPS	-	-	60	78	60	60	60
Drainage Improvements	25	42	50	63	50	50	50
Stormceptor Supply & Install	45	-	-	-	-	-	-
McMeekan Causeway Abutment Stabilization	-	-	250	50	-	-	-
	1,700	1,695	3,165	3,163	810	2,732	3,610
Transit							
Transit Funding - Bus Shelters	-	25	-	-	-	-	-
Marketing Plan, New Bus Shelters & Route Posts	20	7	20	33	20	20	20
	20	31	20	33	20	20	20



**CAPITAL FUND - 2012 Capital Projects**

	2010 Budget (\$000's)	2010 Actual (\$000's)	2011 Budget (\$000's)	2011 Forecast (\$000's)	2012 Budget (\$000's)	2013 Budget (\$000's)	2014 Budget (\$000's)
<b>Road Rehabilitation</b>							
Latham Island Area:							
McDonald Drive	410	498					
N'dilo			810	810	600		(1)
Raccine Road, Ingraham Drive & Doornbos Lane						400	
Central Business District:							
41A St & 49th Ave.							400
51st & 52nd St. Overlay Program			495	694			1,300
52nd Ave. (49th St. - 56th St.)							1,300
Frame Lake Area:							
Cemetery Road							500
Old Airport Road (Borden Drive to Cemetery Road)			1,300	1,184			
Kam Lake Industrial:							
Drybones Drive			200	117			
Deh Cho Boulevard						1,300	
Niven Lake:							
Haener Drive	1,115	1,044					
De Weerd Drive, Driscoll Rd. & Haener Drive						922	
Miscellaneous patching and repairs					100		
	1,525	1,542	2,805	2,805	700	2,622	3,500

**Notes:**

(1) Under the contribution agreement between the City and Yellowknives Dene First Nations, each contributes half of project cost.



**CAPITAL FUND - 2012 Capital Projects**

	2010 Budget (\$000's)	2010 Actual (\$000's)	2011 Budget (\$000's)	2011 Forecast (\$000's)	2012 Budget (\$000's)	2013 Budget (\$000's)	2014 Budget (\$000's)
<b>Solid Waste Management</b>							
Landfill/Baler							
Landfill Expansion	-	-	500	2,300	200	-	-
New Landfill Cell	1,549	529	-	-	-	-	-
Baling Facility Mechanical Upgrades	25	20	25	25	25	25	100
Site Restoration Liability	150	87	150	13	150	150	150
Landfill Closure	-	40	-	-	-	-	-
Disposal of Liquid Waste	-	-	-	10	-	-	-
Landfill Fire Control & Risk Reduction Plan	-	-	-	25	-	-	-
Shelter for E-Waste	-	-	-	30	-	-	-
Recommendations of Wildlife Study	-	1	-	-	-	-	-
3-Cell Salvaging System	-	63	-	-	-	-	-
Ban Commercial Cardboard	-	-	-	25	-	-	-
Centralized Composting Project	-	64	100	145	110	750	50
Overhead Door Replacement	-	-	130	130	-	-	-
Scrap Metal Recycling	100	66	-	34	-	-	-
Landfill Compactor	400	349	-	-	-	-	-
Purchase an Excavator	-	-	-	-	300	-	-
Office/Break Room/ Washroom for Solid Waste Facility	-	-	-	-	120	-	-
	<b>2,224</b>	<b>1,218</b>	<b>905</b>	<b>2,737</b>	<b>905</b>	<b>925</b>	<b>300</b>
<b>Community Energy Plan (CEP)</b>							
Con Mine Geothermal Study	-	180	-	-	-	-	-
CEP Energy Coordinator	75	93	85	85	85	85	85
CEP Implementation/Study	25	-	-	-	-	-	-
CEP Communication	15	-	10	10	-	-	-
CEP Energy Efficiency Projects	385	594	405	881	415	415	415
	<b>500</b>	<b>866</b>	<b>500</b>	<b>976</b>	<b>500</b>	<b>500</b>	<b>500</b>



**CAPITAL FUND - 2012 Capital Projects**

	2010 Budget (\$000's)	2010 Actual (\$000's)	2011 Budget (\$000's)	2011 Forecast (\$000's)	2012 Budget (\$000's)	2013 Budget (\$000's)	2014 Budget (\$000's)
<b>Water &amp; Sewer</b>							
Pumphouses (PHs)/Liftstations(LSs)/Forcemains							
Water Treatment Plant/Reservoir Expansion	3,440	238	1,604	1,850	5,823	5,290	1,500
Liftstations Capital Upgrades	50	0	65	215	65	65	65
Reservoir Flushing, Cleaning & Repairs	60	-	60	30	25	25	60
Pump Replacement Program	150	178	400	90	100	100	-
Monitor & Controls Assessment & Upgrading PHs & LSs	100	79	80	133	75	75	75
Pumphouse & Liftstation Pipe Replacement	280	9	400	947	325	300	300
	<b>4,080</b>	<b>505</b>	<b>2,609</b>	<b>3,265</b>	<b>6,413</b>	<b>5,855</b>	<b>2,000</b>
<b>Other</b>							
Submarine Line Inspection/Assessment	40	29	-	11	-	-	-
Water Meter Replacement & Upgrade	40	15	25	30	15	25	25
Water Meter Replacement for PHs & LSs	15	-	-	-	-	-	-
Water Meter Readers	-	-	-	90	-	-	-
Water & Sewer System Review	-	-	-	1	-	-	-
Liftstation GenSet Installation (Backup Power)	300	12	350	662	-	-	-
Fire Hydrant Repair /Upgrade	30	30	30	30	30	30	30
Water Licence Study & Report Requirements	-	-	200	200	100	50	25
PH#4 Sodium Hypochlorite Generation	-	-	-	-	400	-	-
Personal Gas Monitoring Equipment Upgrade	-	-	-	-	30	-	-
	<b>425</b>	<b>86</b>	<b>605</b>	<b>1,024</b>	<b>575</b>	<b>105</b>	<b>80</b>

**CAPITAL FUND - 2012 Capital Projects**

	2010 Budget (\$000's)	2010 Actual (\$000's)	2011 Budget (\$000's)	2011 Forecast (\$000's)	2012 Budget (\$000's)	2013 Budget (\$000's)	2014 Budget (\$000's)
<i>CMP Replacement Program:</i> (includes repavement and concrete)							
<i>Taylor Road Area:</i>							
Gitzel Street (to Matonabee incl. Dakota and Albatross Crt., 2010 Paving)	1,000	839					
Lanky Court (2014 Water & Sewer, 2015 Paving)	-						900
Matonabee Street (2012 Water & Sewer, 2013 Paving)	1,500				1,775	1,200	
<i>Forrest Drive Area:</i>							
Con Road (2014 Water & Sewer, 2015 Paving)							1,225
<i>Frame Lake South:</i>							
Horton Crescent (2013 Water & Sewer, 2014 Paving)						1,500	750
Knutsen Ave. (2011 Water & Sewer, 2012 Paving)			2,000	2,350	450		
Woolgar Ave./Range Lake Rd. (2010 Water & Sewer, 2011 Paving)		1,472	700	504			
Byrne Road (2014 Water & Sewer, 2015 Paving)							925
	<b>2,500</b>	<b>2,311</b>	<b>2,700</b>	<b>2,854</b>	<b>2,225</b>	<b>2,700</b>	<b>3,800</b>



CAPITAL FUND - 2012 Capital Projects

---

		2012 Budget Recommended (\$000s)	M.E.R. Reserve (\$000s)
<b>Public Works &amp; Engineering</b>			
	<u>Page</u>		
<b>Fleet Management</b>	262		
1088-97 Ford F-150		32	32
1089-97 Ford F-150		32	32
1172-08 Crown Victoria B49		50	50
2014-98 938G Loader		195	195
2018-06 Cat Loader IT14G		205	205
2024-97 938F Loader		195	195
2119-90 IHC 2554 Water Tanker		175	175
2126-04 Sterling Vac Truck		400	400
3028-90 Zamboni (GMA)		120	120
T011-80 45 Ton Low Boy		45	45
Fleet Total		<u>1,449</u>	<u>1,449</u>

**CAPITAL FUND - 2012 Capital Projects**

		2012 Budget Recommended (\$000s)	Formula Funding (\$000s)	Other Revenue (\$000s)	MACA Capital Grant (\$000s)
	<u>Page</u>				
<b>Engineering &amp; Garage</b>					
New Parking - Garage	266	150	150		
Diagnostic, Safety Equipment & Specialty Tools For Mechanics	267	20	20		
Garage - Fire Code & Safety Improvements	268	50	50		
<b>Roads &amp; Sidewalks</b>					
Road Rehabilitation	269	700		300	400
Traffic Lights UPS	273	60	60		
Drainage Improvements	274	50	50		
New Bus Shelters & Route Posts	275	20	20		
		<u>1,050</u>	<u>350</u>	<u>300</u>	<u>400</u>
<b>Solid Waste Management</b>					
<b>Landfill</b>					
Landfill Expansion	276	200	200		
Baling Facility Mechanical Upgrades	278	25	25		
Site Restoration	279	150	150		
Centralized Composting Project	280	110	110		
Purchase an Excavator	281	300	300		
Office/Break Room/Washroom for SWF	282	120	120		
		<u>905</u>	<u>905</u>	-	-
<b>Community Energy Plan (CEP) Initiatives</b>					
CEP Implementation	283	85	85		
Energy Efficiency Projects	283	415	415		
		<u>500</u>	<u>500</u>	-	-



**CAPITAL FUND - 2012 Capital Projects**

		2012 Budget Recommended (\$000s)	Formula Funding (\$000s)	Water & Sewer User Fees (\$000s)	Other Revenue (\$000s)	M.E.R. Reserve (\$000s)	Gas Tax Rebate (\$000s)	MACA Capital Grant (\$000s)
	<b>Page</b>							
<b>Pumphouses/Liftstations (PHs/LSs)</b>								
Water Treatment Plant	286	5,823		1,304			4,519	
Liftstations Capital Upgrade	289	65	65					
Reservoir Flushing, Cleaning & Repairs	291	25	25					
Pump Replacement Program	292	100	100					
Monitor & Controls Assessment & Upgrade	294	75	75					
Pumphouse & Liftstation Pipe Replacement	296	325	325					
<b>Other</b>								
Water Meter Replacement	297	15	15					
Fire Hydrant Repair and Upgrade	298	30	30					
Water License Study and Report Requirements	299	100	100					
PH#4 Sodium Hypochlorite Generation	300	400	400					
Personal Gas Monitoring Equipment Upgrade	301	30	30					
<b>CMP Replacement Program</b>	302	2,225	901	1,324				
		9,213	2,066	2,628	-	-	4,519	-
<b>PW Subtotal</b>		<b>13,117</b>	<b>3,821</b>	<b>2,628</b>	<b>300</b>	<b>1,449</b>	<b>4,519</b>	<b>400</b>

## CAPITAL FUND - 2012 Capital Projects

---

DEPARTMENT	PUBLIC WORKS & ENGINEERING
DIVISION	FLEET MANAGEMENT
PROJECT	Upgrading of Fleet
COST	\$1,449,000
STATUS	Replacement/ New
PHASE	Ongoing
DESCRIPTION	<p>The mobile equipment fleet has a replacement value of \$12.5 million and must be maintained to meet the service levels expected by residents. The City has a fleet of 118 heavy-duty and mobile equipment that support Fire and Ambulance, Road Maintenance, Water and Sewer Maintenance, Solid Waste, Parks, Arenas and Administrative functions, plus 24 stationary engines for emergency power generation and fire pumping capacity.</p> <p>The replacement vehicles listed have passed their useful lives according to City practices. In addition, they have been recommended for replacement following an assessment carried out by licenced mechanics. In the 2006 Infrastructure Needs Assessment by Ferguson, Simek and Clark Architects and Engineers, it was noted that nearly half of the City's fleet is beyond its anticipated life span.</p> <p><b><u>Pickups – 43 units</u></b> According to the City of Yellowknife Fleet Management Practices, these vehicles should be reviewed for replacement after five years and replaced after eight years. We currently have 43 pickups and vans in the fleet and two of them are over ten years old. The average age of the fleet is five years. If the policy were followed, the average age of the fleet would be five years. There have been 41 pickups that have been replaced in the last eight years. Replacing the aging</p>

fleet will lower the O&M to operate the fleet. Five pickups have to be replaced every year to maintain the fleet to the policy standard. If the standard is not followed, more maintenance staff will have to be hired to maintain the fleet to a safe and operational level and there will be increased costs. Status: Good – meets standards. Note: Replacement increased from 8 to 10 years.

### **Medium-Duty Trucks – 8 units**

According to the City of Yellowknife Fleet Management Practices, these vehicles should be reviewed for replacement after eight years and replaced after ten years. The City currently has eight medium-duty trucks in the fleet, with none of them over ten years old. The average age of the fleet is four years. If the policy were followed, the average age of the medium-duty truck fleet would be five years. Status: Medium - duty trucks meet standard and no replacements are planned.

### **Municipal Enforcement Vehicles – 4 units**

These are to be replaced every three years or 100,000 km. The average age of the fleet of four Municipal Enforcement vehicles is three years and one has over 100,000 km. Due to heavy use, Municipal Enforcement vehicles require a high amount of maintenance (nearly five times that of similar vehicles in the fleet). For this reason, it is important to maintain the replacement of the vehicles. One Municipal Enforcement vehicle must be replaced yearly to maintain City standards reduce O&M costs and labour requirements. With the replacement of one vehicle this year, the City will meet the practice identified. Status: Good – standard is maintained.

### **Heavy Trucks – 18 units**

The 18 heavy-duty trucks and trailers, includes trailers, tandem tractors, dump trucks, and street sweepers.



One of the heavy-duty trucks and trailers is due for replacement. The heavy trucks are to be replaced every 12 years. Currently, the fleet is ten years old and, if the replacement policy is followed, the average age should be six years old. Trucks are used for City projects and snow removal in the winter. The cost of operating these vehicles over hiring contractors is about half. Each truck is operated for about 1,000 hrs/yr, saving the City \$45,000/year for each truck it operates rather than contracting out.

Trailers are reviewed when aged out. If practical, the trailer is refurbished and returned to service. The dump trailer (due to more use and normal wear and tear) is replaced when aged out.

As trucks get older, increased maintenance and repairs are required, such as replacing motors and transmissions at costs of \$20,000 and \$10,000 respectively. Breakdowns inevitably occur when equipment is needed, resulting in a cost to the City to engage contractors at a much higher cost than using our own forces. Condition: if replacements continue, heavy duty fleet condition is good.

### **Heavy Equipment – 10 units**

The heavy equipment is to be replaced every 12 years, and two are due for replacement. Currently, the age of the fleet is six years old, and the average age should be six years old. Heavy equipment is used for City projects and snow removal in the winter. The cost of operating our equipment rather than hiring contractors is about half. Each piece of heavy equipment is operated for about 1,000 hrs/yr, saving the City \$45,000 per year for each piece of heavy equipment it operates. As heavy equipment gets older, increased maintenance and repairs are required, such as replacing motors and transmissions at a cost of \$30,000 and \$20,000 respectively. Breakdowns inevitably occur when equipment is needed, resulting in a cost to the City to engage contractors.

The City has explored contracting out heavy equipment services and leasing vehicles, but recommends the acquisition of replacement vehicles as its most cost-effective option. Condition: Heavy equipment fleet is in good condition.

### **Mobile Tractors – 6 units**

The average age of the fleet is six years. This includes Zambonis, skid steers, compactors, and forklifts. The anticipated life span is ten years. The average age of the fleet, if replaced as per schedule, should be five years. This equipment is currently tasked with sidewalk maintenance in the winter. Work in the summer includes sidewalk resurfacing and cold mix patches, Community Services trail repairs, and grounds maintenance. Two are due for replacement. Condition: Good.

### **Emergency Vehicles – 9 units**

This includes fire trucks, ambulances and water trucks. The average age of the fleet is 15 years. Due to increased demand, the replacement life cycle standard has been re-evaluated by the Public Works and Fire and Ambulance divisions. The standard for replacement was reduced from 30 years to 20 years for most firefighting equipment. This was done after a replacement part was not available for a fire truck that was over 20 years old. The vehicle was out of service for eight weeks until a part was finally found at a used car wrecker. Parts are no longer manufactured for vehicles over 20 years old.

Ambulances are now replaced on a 12-year cycle due to heavy use and reliability issues with ambulances as they get older. We have three ambulances and one is replaced every four years. The newest is placed on “first out the door” service and the oldest is surplus. Status: Most of the Emergency Vehicles are due for replacement since the re-evaluations of the life cycle. A new piece of Emergency equipment is due for replacement in 2017 when the new replacement schedule will be realized.



### **Other Equipment – 34 units**

This category includes the miscellaneous equipment required by City departments to do their work. Included are riding mowers, snowmobiles (Municipal Enforcement Division), all-terrain vehicles (firefighters), Solid Waste Facility baler, light trailers (Community Services and Public Works), line-painters, crack sealing equipment, trailer mounted water pumps, and ground thawing equipment. Equipment in this group has a varied life expectancy and replacement cost. Status: for the most part, the Other Equipment group is in good shape and the replacement schedule allows for safe work and consistent work flow.

### **Stationary Engines 21 Units**

Our fleet mechanics also maintain and service 21 stationary engines. These include standby generators for City water and sewer supply and City facilities (City Hall, Fire and Ambulance Division, Multiplex/Fieldhouse). The stationary engines provide standby electricity on water and sewer services in times of power outages or natural disasters. The estimated value of the stationary engines is approximately \$4.8 million. Many of the existing engines are older; five are over 30 years old, 12 are over 20 years old, 14 are over 10 years old, and only seven are under 10 years. Parts are often unavailable for engines over 20 years old. Though these engines get little use, even small breakdowns may lead to lengthy repairs.

The Mobile Reserve Fund is not used to replace stationary engines though the fleet resources are used to maintain them. It is recommended to departmental managers that the older stationary engines be replaced. Fleet-wide, it is recommended that one engine a year be replaced until all stationary engines are less than 20 years old.

### **Summer Vehicles (12)**

Summer vehicles are those that have been replaced but remain useful in a secondary or low priority role. There are nine light vehicles used mainly by Community Services Parks staff in the summer, or administration vehicles year-round, and one Heavy Equipment class dump trailer used in winter as a back-up or with a leased tractor for winter snow removal. If repair of a summer vehicle exceeds an estimated cost of \$500, the vehicle may be removed from service at the discretion of the Works Superintendent.

This project addresses City Council's Goal #4.1<sup>1</sup>.

### **O&M IMPACT**

Maintenance costs will decrease if the City of Yellowknife Fleet Management Practices are followed due to reduced fuel consumption and repair costs. Residents will be highly satisfied with City services. If the fleet is replaced according to schedule, services will be more consistent and not interrupted due to equipment failure.

---

<sup>1</sup> Be accountable to residents by ensuring open and accessible information flow, and accessible decision making.





## CAPITAL FUND - 2012 Capital Projects

---

**DEPARTMENT** PUBLIC WORKS & ENGINEERING

**DIVISION** GARAGE

**PROJECT** New Parking - Garage

**COST** 2012: \$150,000

**STATUS** Replace

**DESCRIPTION** The original garage has been in service since the mid-1970s, and was moved from Pine Point in the mid-1980s. This building has exceeded its useful life as a heated equipment garage but is still usable for cold storage. A heated parking space is required for diesel-fuelled heavy equipment in the winter.

Due to sinking, the original concrete shop floor was replaced with gravel. The heat from the building has caused permafrost melt and subsequent sinking. The existing shop floor is now failing because retracting permafrost is causing shifting, foundation failure, heat loss, overhead door misalignment and the need for frequent leveling of the building. The building also has large gaps between the foundation and the building, allowing substantial heat loss. One fire exit is currently not functional. Additionally, the garage is overcrowded as it houses some of the City's snow removal and sanding equipment as well as patching equipment and patching products.

The proposed new building would measure 4,800 sq. ft. (80' x 60') to house up to eight pieces of heavy equipment, small tools, and various other products. The design temperature would be between 5 to 10°C. This will accommodate melting of snow and ice on equipment and maintain the minimum temperature at which diesel engines will start. Savings on energy and heating will be substantial.

If we compare the fuel use for this building to the main garage, the costs are much higher. The building has sunk approximately 0.5 m since it was installed, and may continue to sink. With a new building, we will be able to consider alternative sources of heat (e.g. sewage heat recovery from Liftstation #5 and wood pellet heating).

This project was publicly tendered in 2011. Three tenders were received, all of them exceeding the budget of \$800,000 (2011 \$750,000 plus \$50,000 carryover). The original budget was based on an estimate the City received in 2009 with a percentage markup. However, after the public tender process, it was clear that the project would be over budget so it was decided to cancel the tender and defer the project until 2012. An additional \$150,000 will be required to cover the shortfall from the 2009 estimate.

This project works toward Council's Goal #4.1<sup>1</sup>.

### O&M IMPACT

Reduce building maintenance costs, fuel usage and a larger, more cost-effective building.

---

<sup>1</sup> Be accountable to residents by ensuring open and accessible information flow and accessible decision making.



**CAPITAL FUND - 2012 Capital Projects**

---

**DEPARTMENT** PUBLIC WORKS & ENGINEERING

**DIVISION** GARAGE (MECHANICS SHOP)

**PROJECT** Diagnostic, Safety Equipment and Specialty Tools for Mechanics

**COST** 2012 \$20,000 – Safety Improvements & Diagnostic Equipment  
2013 \$20,000 – Safety Improvements & Diagnostic Equipment

**STATUS** Ongoing

**DESCRIPTION** The value of the City's 142-unit fleet is approximately \$12.5 million (118 pieces of equipment, 24 stationary engines).

Vehicle maintenance generates hazardous waste contaminants. Safe handling of hazardous waste is a Workers Safety and Compensation Commission (WSCC) and environmental requirement. Over the next two years, the City will upgrade air monitoring (for carbon monoxide and nitrous oxide) and controls. These were deficiencies pointed out by a WSCC safety audit of the maintenance garage area. Air quality control monitoring and other operational procedures will also be rectified.

Diagnostic maintenance manuals will help mechanics troubleshoot problems and reduce pollution by providing better maintenance practices. Nearly all new equipment utilizes code readers to troubleshoot electronic and mechanical problems. Each make and model requires specialized equipment to read it.

This project works toward City Council's Goal #4(c)<sup>1</sup>.

**O&M IMPACT** The acquisition of diagnostic manuals will greatly reduce O&M and enhance our preventative maintenance program. An increase in fuel efficiency and work output of equipment is expected. Increased worker safety and comfort, which in turn reduces sick leave and health effects from carbon monoxide and nitrous oxide, are high priorities.

---

<sup>1</sup> Become a preferred employer.

## CAPITAL FUND - 2012 Capital Projects

---

**DEPARTMENT** PUBLIC WORKS & ENGINEERING  
**DIVISION** CITY GARAGE  
**PROJECT** Fire Code and Safety Improvements  
**COST**  
2012 \$50,000  
2013 \$50,000  
2014 \$50,000  
**STATUS** Repair  
**PHASE** Ongoing

**DESCRIPTION** The City garage, which houses a large portion of the City fleet valued at \$12.5 million, has a floor area of 1,971 square metres. The cost of rebuilding the garage is estimated at over \$4.52 million. The building is essential to the City's response to both daily and emergency circumstances. The garage is an alternative operations centre for Northland Utilities, should its main office be destroyed.

In an Occupational Health and Safety audit of the garage, deficiencies were found, such as:

- Fire suppression issues
- No fire retardant paint
- No sprinkler system
- Lack of proper storage for hazardous goods

### 2012

Repair water service and fire suppression system. This was identified in Ferguson, Simek, and Clark's technical assessment of the building. This was not done in 2011. Pine Point shop had to be re-leveled, so funds were used for that instead.

### 2013

Continue fire and occupational health and safety upgrade to building. Continue repairs identified in Ferguson, Simek, Clark's technical assessment report at the City garage. Improve fire separation from garage to building. Install spill pad for fuel pumps, and repaint interior walls.

### 2014 - Ongoing

Repairs and maintenance of a capital nature must continue annually in future, and projects may increase or decrease in value to meet the need.

The project works toward Council's Objective # 2.3<sup>1</sup>.

### **O&M IMPACT**

O&M costs will decrease due to less damage to ceilings and walls from leaks, and greater heat retention.



---

<sup>1</sup> Develop smart and sustainable approaches to energy, water and sewer, waste management, and building systems.



## CAPITAL FUND - 2012 Capital Projects

---

<b>DEPARTMENT</b>	<b>PUBLIC WORKS &amp; ENGINEERING</b>
<b>DIVISION</b>	<b>ROADS &amp; SIDEWALKS</b>
<b>PROJECT</b>	<b>Road Paving/Rehabilitation</b>
<b>COST</b>	<b>2012: \$ 700,000 * (see 2012 write up below)</b> <b>2013: \$2,622,000</b> <b>2014: \$3,500,000</b>
<b>STATUS</b>	<b>Replacement</b>
<b>PHASE</b>	<b>Ongoing</b>



**DESCRIPTION** Paving work includes not only new asphalt, concrete curb and sidewalks, but also considers the replacement and future needs of the underground infrastructure of water, sewer, storm, traffic communication, power, telephone, cable, fibre optics and more.

The typical design life of pavement is generally between 20 to 25 years, but will vary significantly. This design life is dependent on various factors such as traffic volumes, vehicle types, geotechnical conditions, construction practices, and adequate maintenance. The design life of 20 to 25 years applies to most City streets, except for the Kam Lake Industrial Subdivision where the roads were paved with no base reconstruction. The paved roads in Kam Lake Industrial

Subdivision will likely have a life of 10 years or less. It is important to note that concrete curbs and sidewalks are not installed in downtown alleys or on roadways with rural cross sections. In areas of potential settlement, the City considers asphalt sidewalks as opposed to concrete sidewalks as they are less costly and are easier to maintain or repair should settlements occur.

The construction of new roads generally coincides with the development of new subdivisions. The replacement of roads generally follows the replacement of water and sewer infrastructure. Otherwise, paving is scheduled for reconstruction when a road is in poor condition and may endanger the public, or when maintenance and repairs are no longer cost-effective. The paving of roads may be done in the same year as water and sewer infrastructure replacement or may be delayed a year or two to allow for settlement, depending on the ground conditions.

There has been concern expressed by the public as to the condition of the sidewalks and roads in the Central Business District. The majority of roads there are over 30 years in age, well beyond their life expectancy. The replacement of several downtown streets is scheduled over the next few years.

As streets are reconstructed, the City works with Northland Utilities Limited to ensure that street lighting levels are evaluated and increased, as required by national standards. Additional underground duct work is being coordinated in this work with Northland Utilities Ltd., NorthwesTel Inc. and NorthwesTel Cable Inc. for present and future needs.

### 2012 Road Paving / Reconstruction Projects

The 2012 target budget for paving and road reconstruction projects is \$1,600,000, which is a historically low figure. Considering the relatively poor condition of numerous sections of water and sewer infrastructure, the Department of Public Works is recommending a transfer of \$1,200,000 from the Paving Program to the CMP Replacement Program. This would leave a \$400,000 balance for major overlay projects which have been deferred due to larger scale paving locations.

#### N'dilo Paving Program – Phase 2

On June 30, 2010, the City of Yellowknife entered into an agreement with the Yellowknives Dene First Nations (YKDFN) to pave the roads in N'dilo. The funding commitment is a matching agreement, in that the City will contribute \$705,000 to the project and the YKDFN will also contribute \$705,000, over a two-year period.

In 2012, the City will contribute the remaining \$300,000 which will be matched by the YKDFN. This will fulfill the agreement for a total contribution budget of \$1,410,000.

### 2013 Road Paving / Reconstruction Projects

#### Deh Cho Boulevard Reconstruction

With the construction of the Deh Cho Bypass Road in 2010, there has been a significant increase in heavy truck traffic on Deh Cho Boulevard, as this is now the main route for trucks entering the Kam Lake Industrial area. Deh Cho Boulevard is currently undergoing significant deflection which is causing very poor road conditions.

This work will require large excavations and reconstruction of the road base as well as stabilization methods to ensure that the heavy truck traffic can be supported by the road base.

#### Old Town Paving – Raccine Road, Ingraham Drive, and Doornbos Lane

Public Works would like to dedicate a portion of the 2013 paving budget to placing asphalt on the roads on Pilots Monument Hill, which would include Ingraham Drive, Raccine Road and Doornbos Lane.

There are several factors that support this direction. Maintenance of this hill in both summer and winter is problematic. The extreme nature of approach slopes and exiting slopes make maintenance more difficult, sanding and plowing in the winter as well as grading and dust control in summer months. Pilots Monument is also a prominent tourist attraction from which to view Yellowknife.

Due to the nature of roadways in the Old Town, Public Works is unsure if concrete curb, gutter and sidewalk are applicable in this area. This will be investigated and determined through the detailed design process.

#### De Weerd Drive/Driscoll Road/Haener Drive

Paving of the initial portion of Haener Drive was complete in 2010. The remaining section of Haener, along with Driscoll Road and De Weerd Drive can be completed once all development is complete on these streets. Public Works estimates that all lots should be developed and tied into the water and sewer systems by 2013.

### 2014 Road Paving / Reconstruction Projects

#### 52<sup>nd</sup> Avenue (Between 49<sup>th</sup> Street and 56<sup>th</sup> Street)

Several sections of this street have undergone significant differential settlement. The initial plan was to complete resurfacing block by block but, upon further investigation and taking into consideration the age of the storm water system, it was decided that this full section be completed in one construction season.



Downtown Street Overlay Program – 51<sup>st</sup> Street and 52<sup>nd</sup> Street

Public Works has determined a method of road resurfacing that may make construction less invasive and timelier on streets that have no differential settling problems. Many downtown streets have no movement problems, but the concrete sidewalk is severely deteriorated. A prime example of this is a section of 51<sup>st</sup> Street, between 51<sup>st</sup> Avenue and 52<sup>nd</sup> Avenue (next to Polar Bowl). Instead of complete removal of asphalt and concrete materials, the contractor will be required to remove dilapidated structures, such as sidewalks, while keeping intact the asphalt roadway. New concrete appurtenances will then be installed and an overlay of asphalt will be placed to resurface the road.

This method will save time and budget by not completely removing the road surface and road bed. It will also save on materials by not importing new aggregate to rebuild the road base, which is in relatively good condition to begin with.

Cemetery Road

The internal roads of the cemetery are surfaced, however, the road from Old Airport Road to the cemetery is gravel and has to be constantly maintained by Public Works. Resurfacing this road with asphalt will dramatically reduce the amount of maintenance required to keep the surface dust and pothole free.

41A Street and 49<sup>th</sup> Avenue

These are smaller lane streets off Franklin Avenue adjacent to 41<sup>st</sup> Street. Several new homes were placed in this area around 2008 and the roads remain gravel surfaced. Resurfacing these roads will provide a finished road surface for the residents and will also reduce dust and pothole maintenance that currently has to be done by Public Works.

**Three Year Summary**

**2012**

Patching and Overlays	\$ 100,000
N'dilo (City and YKDFN portion)	<u>\$ 600,000</u>
Total:	\$ 700,000

**2013**

Deh Cho Boulevard Reconstruction	\$1,300,000
Raccine, Ingraham and Doornbos	\$ 400,000
De Weerd/Driscoll Drive	<u>\$ 922,000</u>
Total:	\$2,622,000

**2014**

Downtown Overlays – 51 <sup>st</sup> Street and 52 <sup>nd</sup> Street	\$1,300,000
52 <sup>nd</sup> Avenue (49 <sup>th</sup> Street to 56 <sup>th</sup> Street)	\$1,300,000
Cemetery Road	\$ 500,000
41A Street/49 <sup>th</sup> Avenue	<u>\$ 400,000</u>
Total:	\$3,500,000



CAPITAL FUND - 2012 Capital Projects

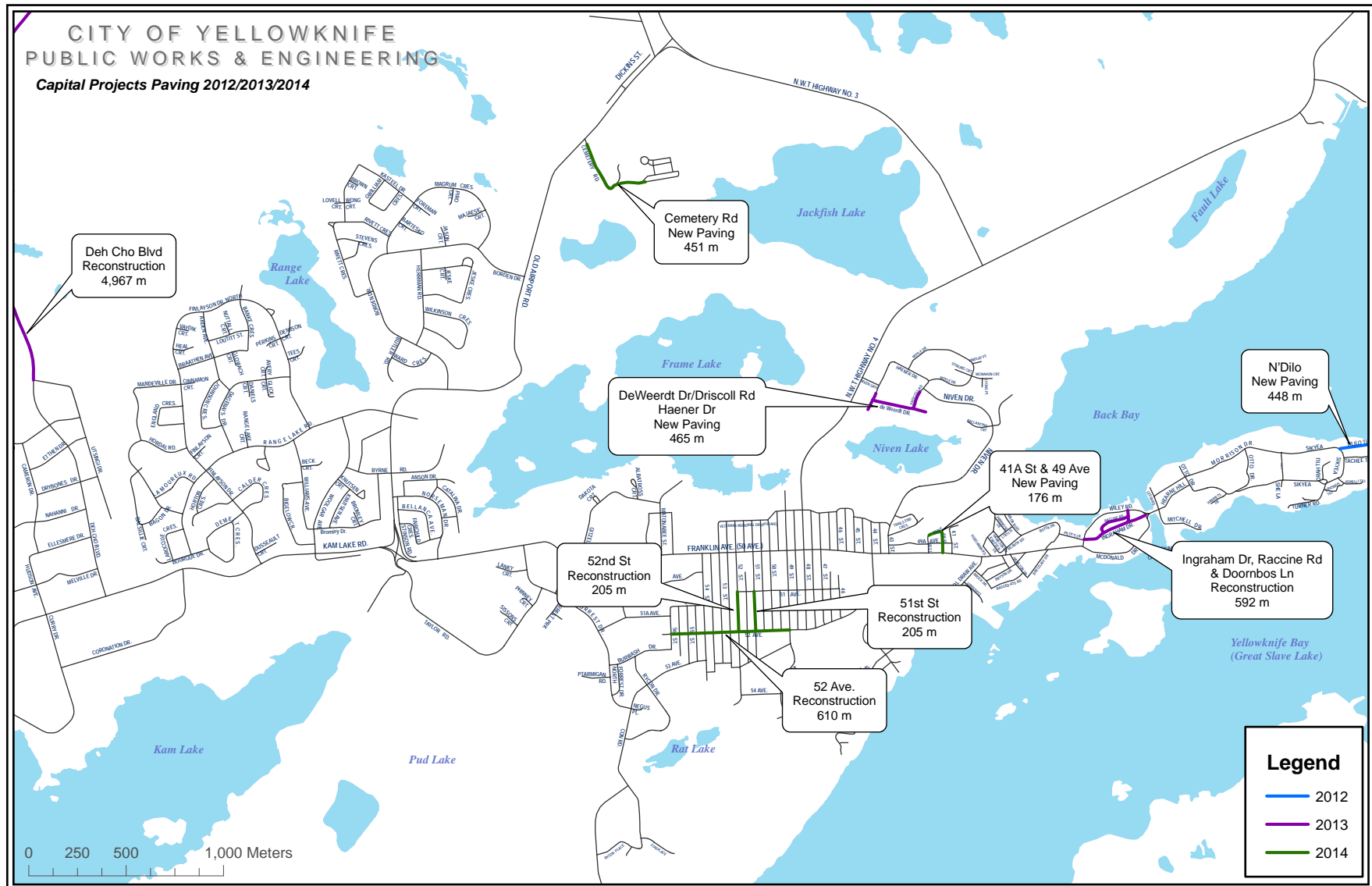

## CAPITAL FUND - 2012 Capital Projects

---

**DEPARTMENT** PUBLIC WORKS & ENGINEERING  
**DIVISION** ROADS AND SIDEWALKS  
**PROJECT** Traffic Lights UPS, Surge Protection and New Cabinets

**COST**

2012	\$60,000
2013	\$60,000
2014	\$60,000

**STATUS** New

**PHASE** Ongoing

**DESCRIPTION** It became apparent in the summer of 2004 that several key intersections serviced by traffic lights must remain lit during blackouts. Several incidents and numerous close calls when the traffic lights were down, both during power outages and when the lights were damaged during lightning strikes, have become public safety issues and need to be addressed.

Most traffic lights are equipped with some sort of surge protection. However, better surge protection is required for both lights and telecommunications lines. It appears from our investigation of the 2004 incidents that telecommunications lines may have been the source of the power surge that damaged circuit boards in the control boxes at affected intersections. Given that the electrical power suppliers have little control over their product, it is crucial that the City upgrade the traffic control boxes to provide the protection that suppliers cannot guarantee.

In the summer of 2008, a number of lightning strikes disrupted power in the city. These power outages also affected traffic lights which led to all traffic light-controlled intersections becoming four-way stops. When power returned, the lights defaulted to flashing amber and red before resuming the normal cycle. On some

occasions, the normal cycle did not begin and a Public Works & Engineering employee had to be called out to visit each traffic light and reset the control to start the sequence again.

If a UPS (uninterrupted power supply) and cabinet were installed at each intersection, the traffic lights would continue operating during power outages. Implementation of LED lights, which use only 10% of the power of the previous system, has greatly reduced the size of the UPS, thus requiring a smaller battery backup than the previous system.

Installing traffic light UPS will ensure that public safety and control are maintained regardless of the circumstances, promoting safe driving conditions, even during power outages.

The intent is to install UPS at the remaining signalized intersections still without backup power in a systematic manner over the next few years.

This project works towards City Council's Goal #4.1<sup>1</sup>.

### O&M IMPACT

Will increase public safety and reduce call-outs for Public Works & Engineering staff.

---

<sup>1</sup> Be accountable to residents by ensuring open and accessible information flow and accessible decision making.

## CAPITAL FUND - 2012 Capital Projects

---

<b>DEPARTMENT</b>	<b>PUBLIC WORKS &amp; ENGINEERING</b>	
<b>DIVISION</b>	<b>ROADS AND SIDEWALKS</b>	
<b>PROJECT</b>	<b>Drainage Improvements Including Storm Sewer Repairs</b>	
<b>COST</b>	<b>2012</b>	<b>\$50,000</b>
	<b>2013</b>	<b>\$50,000</b>
	<b>2014</b>	<b>\$50,000</b>
<b>STATUS</b>	<b>Existing</b>	
<b>PHASE</b>	<b>Ongoing</b>	
<b>DESCRIPTION</b>	Drainage issues take considerable effort to resolve, as many locations have not been designed with drainage in mind. This causes significant efforts from City staff as well as from contractors hired by the City to minimize property damage.  This past spring, a fast melt occurred even though the accumulated snowfall was only average. The rate of the melt was increased due to the warm spring weather and local development, making direct drainage channels rather than the slower drainage natural tundra provides. This situation caused flooding of property. The flooding also eroded the soil over the force-main going to Fiddler's Lake Lagoon and exposed the pipe. A washed-out road creates a hazard to the residents since there is no safe way to get off the property. Furthermore, service and emergency vehicles cannot access the property while the flooding is occurring.  One ditch in Kam Lake does not drain because it has bedrock that should have been blasted in the past. This has resulted in the property owner having to set up a series of pumps and hoses to deal with what the drainage system should remove.  Along with some ditches that have to be widened or bedrock blasted for drainage, there are several culverts	

of insufficient size which must be replaced to allow for heavy spring runoff. There are many culverts of sufficient size which are not effective because their elevation is incorrect due to height-of-fill increase from development. These should be re-installed to flow water away from property.

The City has had a number of requests from concerned residents regarding the storm water drainage along sections of Forrest Drive and Dagenais Drive. In both instances settlement of the road has caused significant ponding which either resulted in roadways being undermined or homes being damaged during heavy rainfalls. Since these roads are not scheduled for reconstruction in the near future, the City intends either to extend existing storm sewers in these areas, or to install new storm sewers to alleviate these problems.

This project works toward City Council's Goal #4.1<sup>1</sup>.

### O&M IMPACT

This will lower pumping costs for both the commercial/ industrial sector and the City, as well as greatly reducing flood damage and emergency repairs to roads. The City wants to provide continual safe access to property for owners and emergency vehicles.

---

<sup>1</sup> Be accountable to residents by ensuring open and accessible information flow and accessible decision making.



## CAPITAL FUND - 2012 Capital Projects

---

<b>DEPARTMENT</b>	PUBLIC WORKS & ENGINEERING	
<b>DIVISION</b>	ROADS AND SIDEWALKS	
<b>PROJECT</b>	Public Transit – Transit Enhancements, New Bus Shelters and Route Posts	
<b>COST</b>	2012	\$20,000
	2013	\$20,000
	2014	\$20,000
<b>PHASE</b>	Ongoing	
<b>DESCRIPTION</b>	<p>Public Transit has several facets that require annual funding to install and maintain functionality and convenience for the public, including route posts, schedules, and bus shelters to name a few.</p> <p>As Yellowknife continues to grow into areas such as Niven Lake and the Con/Rycon area, the transit system will also have to expand in time. Studies have been completed, and it is anticipated that the recommendations from these projects will be phased in as transit expands into areas currently without transit service. Additional bus route posts and glass bus shelters will be required as changes are made to the existing transit routes.</p> <p>This project works toward City Council's Goal #2.2<sup>1</sup>.</p>	
<b>O&amp;M IMPACT</b>	As the number of bus stops and bus shelters increases, O&M will increase.	

---

<sup>1</sup> Improve transit, roads, sidewalks, recreation facilities and trails with an emphasis on active transportation.

## CAPITAL FUND - 2012 Capital Projects

---

**DEPARTMENT** PUBLIC WORKS AND ENGINEERING

**DIVISION** SOLID WASTE FACILITY

**PROJECT** Landfill Expansion

**COST** 2012: \$200,000

**STATUS** Ongoing

**DESCRIPTION** The existing landfill is nearing capacity. Based on past engineering reports the projection for landfill expansion had been 2007. Upon further study it was noted that this projection was based on an elevation of 210 metres. In order to promote drainage of the site, a grade of at least 3% must be used in the final closure on vegetated surfaces. This is not possible without portions of the landfill being mined or excavated and garbage removed. Taking this into account, the final elevation at the peak of the landfill will be approximately 213 metres. Given these new circumstances the landfill can accommodate approximately three more years of waste. Landfill management plans are currently being implemented to fill areas of the landfill properly and to start the grading process for final closure.

The most logical area identified for expansion is the adjacent quarries which will become available for use in the near future. By using these quarries, the City will continue using the Solid Waste Facility in its current location with very little additional hauling. However, this location is approximately 3 km from the airport. According to a Transport Canada guideline contained in "Land Use in the Vicinity of Airports" (TP 1247) no bird-attractant land use should be allowed within an 8 km radius of airport reference points because it would be considered extremely hazardous to aviation safety. Where hazardous land uses are already established, remedial actions may be taken to develop management programs to minimize the attractiveness of the operations to birds.

In order to obtain a Certificate of Approval for the proposed landfill expansion, the City of Yellowknife is completing a Wildlife Hazard Assessment and an Integrated Wildlife Management Plan that will reduce the risks posed to aircraft, including gulls that may be using the landfill. In order to meet these requirements it will be necessary first to determine the existing conditions at the landfill as they relate to wildlife hazards. The next step will be to develop a plan to manage hazardous wildlife species attracted to the landfill according to the risks they present following the implementation of this plan. The site work will take place during the peak season for gull activity in Yellowknife from late May to October.

The project was tendered publicly and awarded in June 2011. The construction is currently underway and is scheduled to be completed in October 2011. The additional funding will be required to finalize the project and complete other parts of the project such as fencing access construction.

\*Note: Depending on the final approved design of the landfill, future funding may be required to meet the City's 20-year needs in terms of landfill use.

This project works toward meeting Council's Goal #4.1<sup>1</sup>.

**O&M IMPACT** To be determined.

---

<sup>1</sup> Be accountable to residents by ensuring open and accessible information flow and accessible decision making.





Aerial View of the Solid Waste Facility

## CAPITAL FUND - 2012 Capital Projects

---

**DEPARTMENT** PUBLIC WORKS & ENGINEERING

**DIVISION** SOLID WASTE FACILITY

**PROJECT** Baling Facility Mechanical Upgrades

**COST**  
2012 \$25,000  
2013 \$25,000  
2014 \$100,000 – Mid-Life Cycle Rebuild on Baler

**PHASE** Ongoing

**DESCRIPTION** The Baling Facility was built in 1992 and has served the needs of the community well over the years. Equipment installed at the time of construction now requires various upgrades or replacement to ensure the handling of solid waste continues in an efficient and cost-effective manner.

In 2003, the main hydraulic ram on the baler failed and had to be replaced. In 2004, two overhead doors and the underground electrical conduit operating the fire suppression system had to be replaced. This year, most of the alarms for the fire suppression system will have to be replaced to pass inspection.

Present equipment includes: dust collector unit, HVAC burners, overhead doors, fire pump and sprinkler system, fire alarm system, electrical components, air compressor, and boilers for in-floor heating.

The boilers for the in-floor heating and air compressor must pass an annual GNWT inspection under the *Boilers and Pressure Vessels Act*. The fire alarm and suppression system must also pass an annual inspection.

In 2006, a City Internal Audit was taken at the Baling Facility. During this inspection, it was noted that several items require upgrades, repairs or replacement. These include electrical, plumbing and heating, and signage

that will be upgraded.

In 2007 the fire suppression pump had to be replaced, repairs made to the building, and modifications made to the air handling units.

Proper maintenance and attention to continued upgrading of equipment ensure a safe work environment for Baling Facility employees.

Over the next three years, the City will have to upgrade the heating system and building to increase energy efficiency.

Operation of the Baling Facility works toward Council's Goal #4(c)<sup>1</sup>.

**O&M IMPACT** O&M costs are increasing yearly due to mechanical breakdowns with equipment that is nearing the end of its lifespan. Adherence to the maintenance schedule of mechanical upgrades will decrease costs greatly since there will be reduced repairs and resultant downtime. Operating efficiency of the Baling Facility will also improve.

---

<sup>1</sup> Become a preferred employer.



## CAPITAL FUND - 2012 Capital Projects

---

**DEPARTMENT** PUBLIC WORKS & ENGINEERING

**DIVISION** SOLID WASTE

**PROJECT** Site Restoration

**COST** 2012: \$150,000  
2013: \$150,000  
2014: \$150,000

**STATUS** Ongoing

**PHASE** Ongoing (Final closure in 2015)

**DESCRIPTION** The City has adopted nationally recommended public sector accounting policies earlier than the GNWT requires adoption. As part of these policies, the City is required to estimate future landfill closure costs and set aside a portion of these costs.

As of December 31, 2010, the net present value of total closure and post-closure costs are estimated to be \$1,274,054. The City has included \$1,146,648 (90%) as part of site restoration liability. Of the total capacity of 700,000 cubic metres, 70,000 cubic metres (10%) remain. It is expected that the existing landfill will be closed in 2012 and site restoration completed by 2015.

There is a difference between the net present value of future landfill liabilities and the actual costs that will be incurred. The difference is estimated to be about \$750,000. In order to avoid the large difference at the end of landfill closure, it is recommended to accrue the amount over the next six years.

In 2012, 2013 and 2014, the City estimates that it will need to set aside \$150,000 each year to fund the future site restoration liability costs.

The new landfill cell is scheduled to be completed in October 2011 and immediately available for use. It is anticipated that the City will begin close-out procedures for the existing working landfill in 2012.

This project works toward Council's Objective # 2.3<sup>1</sup>.

**O&M IMPACT** A capital funding allocation for future landfill site restoration will reduce the impact on the Solid Waste Management Fund and reduce the need for future solid waste user fee increases.

---

<sup>1</sup> Develop smart and sustainable approaches to energy, water and sewer, waste management, and building systems.



## CAPITAL FUND - 2012 Capital Projects

---

**DEPARTMENT** PUBLIC WORKS AND ENGINEERING

**DIVISION** SOLID WASTE FACILITY

**PROJECT** Centralized Composting Pilot Project

**COST**

2012	\$110,000 (Alloo Bucket \$60,000)
2013	\$750,000
2014	\$50,000

**STATUS** New

**DESCRIPTION** In July 2007, Gartner Lee conducted a waste audit at the Solid Waste Facility. The Waste Composition Study showed that 2,100 tonnes of food waste were disposed of from the residential and commercial sector in 2006, accounting for 26% of the total waste stream. They recommended a significant diversion of food waste from the various sectors which would require the development of a centralized organic waste processing facility.

Between December 2007 and April 2008, a study was undertaken by two Ecology North staff members in cooperation with City staff and the GNWT to research centralized municipal composting options. This study was funded by the GNWT Department of Environment and Natural Resources. Their final report recommends that the City implement a pilot project focusing on compostable waste from 10 to 15 commercial sites which would provide 400 to 600 tonnes of compostable material per year. It is recommended the project run for at least two years to allow for two summer seasons of active composting. The compost site is to be at the Solid Waste Facility where a base pad will be constructed out of recycled asphalt, and an electric bear fence will be required.

Composting will divert waste from the Solid Waste Facility, reduce greenhouse gas emissions associated

with production of methane in the landfill, reduce the attractiveness of the active landfill to birds and other wildlife, and produce a finished product that is in high demand in this geographical area. A centralized composting project is more efficient than the smaller backyard composters and because it reaches higher temperatures is able to decompose more waste, including animal products. It is also worth considering that paper products can be composted in a centralized compost site into usable soil, which will save the cost of shipping them south. It is anticipated that the finished compost will be marketable in Yellowknife and usable for many City projects, including cover material for the landfill closure.

The pilot project will be complete in 2011 and an analysis will be conducted to determine the feasibility of City-wide composting. Funding has been earmarked in 2013 for approximately \$750,000, which will be determined in 2012 through the analysis.

This work's toward City Council's Goal #2.3<sup>1</sup>.

### O&M IMPACT

This pilot project will require some time from landfill staff equipment operators to maintain the compost piles, however diverting waste from the main waste stream will reduce the amount of staff time needed at the baler. This funding includes the construction of a composting pad along with an electric bear fence. It also includes organic waste collection services for 20 months as well as a compost and education coordinator for 25 hours per week.

---

<sup>1</sup> Develop smart and sustainable approaches to energy, water and sewer, waste management, and building systems



## CAPITAL FUND - 2012 Capital Projects

---

**DEPARTMENT** PUBLIC WORKS & ENGINEERING

**DIVISION** SOLID WASTE FACILITY

**PROJECT** Purchase of Excavator

**COST** \$300,000

**STATUS** New

**DESCRIPTION** The City took over the recycling program in the early 1990s from Ecology North. A contractor has always been paid by the City to pick up the bins at the depots, deliver them to the Baling Facility and return to the depot. Since City Council adopted the Solid Waste Management Strategic Plan in 2001, there has been an emphasis on increasing waste diversion by increasing recycling. In 2005, more bins were added for corrugated cardboard and HDPE #2 plastics. In 2006, a User Pay System was implemented and bins were added for boxboard, as well as a new depot location on 52<sup>nd</sup> St. Recycling has increased from 2.8% in 2004 to 14% in 2009. In 2010 we added mixed plastics.

The excavator will:

- Sort material; increasing efficiency of recycling efforts.
- Help with bale stacking and reduce cover usage.
- Help with site maintenance and loading trucks along with fire control.
- Be used for emergency firefighting and control.

An excavator used by the contractor costs \$140/hr for 750hrs/yr (approximately \$100,000/year).

This project addresses City Council's Goal #2.3<sup>1</sup>.

### O&M IMPACT

The purchase of an excavator will have an O&M impact because it will increase the workload of staff. However, there will also be an increase in efficiency on landfill operations and not having to work with a contractor's schedule. Some recent partnerships with Interstate Batteries and Precision North Recycling will reduce staff requirements offsetting this additional workload. There are no additional staff requests anticipated at this time.

It is anticipated that the purchase of an excavator will increase the value of recyclables by proper sorting which will increase the value of the material shipped.

---

<sup>1</sup> Develop smart and sustainable approaches to energy, water and sewer, waste management, and building systems.

## CAPITAL FUND - 2012 Capital Projects

---

<b>DEPARTMENT</b>	<b>PUBLIC WORKS &amp; ENGINEERING</b>
<b>DIVISION</b>	<b>SOLID WASTE FACILITY</b>
<b>PROJECT</b>	<b>Office / Break Room / Washroom</b>
<b>COST</b>	<b>\$120,000</b>
<b>STATUS</b>	<b>New</b>
<b>DESCRIPTION</b>	<p>The Baling Facility was built in 1993. This project would create a better environment in the building for breaks, lunch, and staff meetings.</p> <p>Our staff are exposed to a variety of environmental contaminants, including harmful chemicals, on a daily basis. The by-products of rodents, birds and dust are also of concern. When the Scale House was upgraded there was a notable improvement in the morale of the staff who worked there. Similarly, by providing a nicer environment for an office, break room, and washroom, we anticipate that the health and morale of staff will improve, resulting in more productive and happier employees. A proper break room will provide the staff with a healthy environment in which to eat their noon meal. A more accessible office will eliminate the need for citizens and contractors to go through the Baling Facility.</p> <p>This project works toward Council's Goal #2.3<sup>1</sup>.</p>
<b>O&amp;M IMPACT</b>	Occupational health and safety concerns and aesthetic considerations.

---

<sup>1</sup> Develop smart and sustainable approaches to energy, water and sewer, waste management, and building systems.



## CAPITAL FUND - 2012 Capital Projects

---

**DEPARTMENT** PUBLIC WORKS & ENGINEERING

**DIVISION** PUBLIC WORKS & ENGINEERING DIRECTORATE

**PROJECT** Community Energy Plan Funding

**COST** 2012: \$500,000  
2013: \$500,000  
2014: \$500,000

**DESCRIPTION** The Earth's climate is changing, with global temperatures now rising at a rate unprecedented in the experience of modern human society. While some changes in climate have resulted from natural causes and variations, the strength of the trends and patterns of change that have emerged in recent decades indicate that human influences, resulting primarily from increased emissions of carbon dioxide and other greenhouse gases, have now become the dominant factors.

The City of Yellowknife's emissions are projected to increase by 20% over the next ten years. In an attempt to address the implications of this significant increase, the City has developed a Community Energy Plan (CEP) designed to support the community in its effort to reduce emissions and ensure the City leads by example. The CEP has set emission reduction targets of 6% by the community and 20% by the City by 2014 over 2004 levels. The CEP is the visionary strategy of how to achieve emission reductions in Yellowknife.

In addition to reducing Yellowknife's emissions, the CEP provides a framework on how to reduce the cost of energy use within both City operations and the community. The City and community are spending over \$2.8 and \$114 million respectively every year on energy, and forecasts predict a 19% increase in energy expenditures over the next ten years. As energy prices continue to rise, the CEP provides an important plan for

reducing the City's reliance on energy, creating a more economically sustainable community.

**2012 - \$500,000**

**Energy Coordinator Position - \$85,000**

The Energy Coordinator is responsible for implementing the CEP and was made a permanent position in 2009. The Energy Coordinator's primary duties include:

- Identifying funding opportunities to support the implementation of the CEP and assist in the application process;
- Briefing Administration and Council on the energy and emissions implications of their decisions when deemed applicable;
- Providing quarterly updates to the CEP Implementation Advisory Committee on the progress of the CEP;
- Working with facilities and operational managers to identify and implement energy efficiency projects working on a "continuous improvement" policy;
- Working with City departments to ensure purchases give consideration to energy efficiency;
- Working with other levels of government and the private sector to support the implementation of the CEP;
- Working to develop a district energy system in the downtown area; and
- Communicating with the general public and City staff on activities and projects related to the CEP.

**Con Mine Community Energy System, Business Development - \$230,000**

The Community Energy System has moved through the business development phase in 2011, working towards a concessional agreement with Corix to design, build, finance and operate the system. The project will enter the design phase in early 2012 with construction to begin later in the year and buildings to be connected by

2014. In 2012 City will require engineering oversight throughout the design process. Business and legal support will be required in rate design, policy development and regulatory processes. In addition, a detailed resource evaluation is being conducted to refine the sustainable size and quality of the resource.

### **Curling Club Lighting Retrofit - \$60,000**

Lighting above the ice surface at the Curling Club is approaching the end of its useful life. The lights will be replaced with more energy-efficient options and operational controls will be considered to reduce unnecessary lighting when playing surfaces are not in use.

### **Ruth Inch Pool Air Handling Heat Recovery System Top-up - \$90,000**

The air handling units at the pool have reached the end of their useful life and are being replaced through the capital budgeting process. Energy efficiency upgrades which are supported by the CEP budget will be chosen for the system. Heat recovery has been added to both units and improved controllability will ensure air handling better matches facility usage, resulting in energy savings.

### **Waste Wood Fuel Feasibility Study - \$35,000**

The City has installed a wood pellet boiler at the Baling Facility that has the capacity to burn wood chips. This creates a potential opportunity to utilize the existing scrap wood waste stream as a value-added resource to offset imported wood pellets and oil. There is an estimated 2,200 tonnes of scrap wood landfilled annually. It is foreseen that only a portion of this total would be suitable for consuming in the boiler because of environmental and logistical constraints. The process of converting wood waste into a burnable fuel source will have many logistical requirements to coordinate including sorting, chipping, and feeding the chipped wood into the boiler. The City will need to determine if the process can be conducted economically and

## **2013 - \$500,000**

### **Energy Coordinator Position - \$85,000**

### **Community Arena Ice Surface Lighting Retrofit - \$50,000**

The Community Arena uses 18, 1000-watt metal halide fixtures above the ice surface. The present annual cost to light the ice surface area is estimated at \$14,600. A number of lighting options will be considered to replace the existing fixtures, including fluorescent T5s. In addition to reducing costs associated with a more efficient lighting fixture, improving controllability will also be examined so that appropriate lighting levels can be offered to match specific usages. For example ice maintenance requires a lower light level than a hockey game. The project is estimated to save \$7,500 annually.

### **Energy Retrofits and Study - \$200,000**

The City seeks to continuously improve the energy performance of its facilities, leveraging the CEP budget to secure external funding, with most projects qualifying for matching dollars. Facility managers can use these funds to support energy efficiency projects in their facilities, of which CEP funding could represent a portion or the total project amount. The funding amount is determined based on a number of criteria including the level of energy savings the project would produce and environmental benefit. The City now has the responsibility of paying the utility costs of the Curling Club. A number of energy saving opportunities have been identified in previous audits, including upgrading the hot water system and rink lighting.

### **Community Energy System, Engineering Oversight - \$165,000**

Corix will design the system and the City will perform a third-party engineering review of their work throughout the design process. This is important to ensure the



system is designed to operate most efficiently and to appropriate quality levels, as well as to ensure Corix's contractual performance standards are met.

**2014 - \$500,000**

**Energy Coordinator Position - \$85,000**

**Ruth Inch Pool Roof Insulation Upgrade - \$65,000**

The pool roof membrane is scheduled to be replaced. The CEP budget will contribute to increasing the insulation levels to current standards.

**Multiplex Ice Surface Lighting Retrofit - 100,000**

The Multiplex ice surface lighting is being considered for a retrofit to accommodate safety and performance issues. The project represents an opportunity to improve the facility's energy efficiency and improve the control features that will allow lighting to better match usage.

**Energy Retrofits and Study - \$85,000**

**Community Energy System, Engineering Oversight - \$165,000**

The CEP projects support City Council's Goal #2.3<sup>1</sup>.

**O&M IMPACT**

The project will support the reduction of greenhouse gases and costs to the City, residents, and businesses.

---

<sup>1</sup> Develop smart and sustainable approaches to energy, water and sewer, waste management, and building systems.

## CAPITAL FUND - 2012 Capital Projects

---

<b>DEPARTMENT</b>	<b>PUBLIC WORKS &amp; ENGINEERING</b>
<b>DIVISION</b>	<b>WATER &amp; SEWER</b>
<b>PROJECT</b>	<b>Reservoir Expansion, Pumphouse No. 1 Replacement &amp; New Water Treatment Plant</b>
<b>COST</b>	2012: \$5,823,000 2013: \$5,290,000 2014: \$1,500,000
<b>STATUS</b>	Ongoing
<b>DESCRIPTION</b>	<p>The City obtains its potable water from the Yellowknife River. Pumphouse No. 2, located at the Yellowknife River, delivers water to Pumphouse No. 1 via an eight-kilometre submarine pipeline in Yellowknife Bay. Pumphouse No. 1, located at the end of 48<sup>th</sup> Street toward Yellowknife Bay, is the water treatment/distribution and computer monitoring/control centre for the City.</p> <p>Currently, the City's only water treatment is disinfection using chlorine gas. The water is also fluoridated to assist in reducing dental decay.</p> <p>In addition to the daily tests at the pumphouse and twice-weekly tests at the hospital laboratory, the City carries out comprehensive water tests annually or semiannually. In 2001, Public Works &amp; Engineering started a comprehensive year-round water testing and analysis program. This program was followed by an assessment of the water quality and recommendation for improvements to meet more stringent guidelines.</p> <p>In 2004, an on-site pilot scale project of a water treatment plant was commissioned to determine the effectiveness and cost of various treatment processes. The initial pilot plant, which used direct filtration, has been running for more than a year and data have been</p>

collected which will help determine the most cost-effective method for water treatment in the City. Given the erosion of the Yellowknife River in the summer of 2004 which caused a boil water advisory, an additional method of water filtration, membrane filtration, was explored for approximately five months this year to determine its effectiveness in dealing with extremely high turbidity, should the event recur. If water conditions don't change in terms of water levels then the likelihood that the City will once again experience the high turbidity conditions is high. The current phase of the project requires sufficient time to ensure the proper method of water treatment is identified to meet the City's current and future needs. Data for water conditions must be collected in all four seasons to determine how these conditions may affect the treatment quality. In terms of the membrane technology, the spring breakup was the most important time of the year for testing to be completed because water temperatures are at their coldest and the turbidity is usually at its highest. When all the data are collected it will then be analyzed and used in the preliminary design of the treatment plant. Once the preliminary design has been completed and reviewed, then the actual design of the water treatment plant will take place. Since the project has been initiated and given the extended time frame to consider all factors, all funds allocated to this must remain within the project. These funds should not be subject to change given the magnitude and importance of the project.

In 2009, the GNWT adopted the Canada Drinking Water Guidelines as legislation, thus requiring the City to comply with the new guidelines. The new guideline states that: waterworks systems that use a surface water source or a groundwater source under the direct influence of surface water should filter the source to meet the turbidity limits. As well, increased water quality criteria that are more stringent than the current drinking



water quality guidelines are expected to be established in the future. For example, reduced acceptable levels of turbidity and trihalomethanes are currently under review and its resulting requirement for further treatment is expected to be forthcoming within the next couple of years. Public demand for improved water quality is expected, which would in turn establish the need for water conditioning in the future.

Since the city obtains its water from the Yellowknife River, a surface water source, there is always a potential for either of the water-borne pathogens (*Cryptosporidium* and *Giardia lamblia* which causes giardiasis, referred to as beaver fever) to enter our water supply. To date, Yellowknife has not experienced an outbreak of either of these pathogens. Although the likelihood of an occurrence is low, the City should still establish emergency response procedures. A key emergency measure, besides issuing a boil water order, would be to install appropriate water treatment processes.

During the summer of 2004, a boil water advisory was issued because of the high level of silt in the Yellowknife River. The level of silt exceeded the guidelines.

During the 2002 - 2004 budget planning process, it became apparent that another related factor needed to be considered simultaneously for the project. Pumphouse No. 1 was constructed in 1948 and added to piece-by-piece from 1968 through the mid 1980s. It has been long overdue for replacement and was originally planned to be done in the early 1990s following the construction of the new reservoir (1991). The new pumphouse building has been designed to be located on top of the reservoir. The extensive growth of the City over the recent past has created an additional burden on the capacity of the reservoir. The current demand is starting to exceed the capacity of the

reservoir. In order to meet the growth of the City, the reservoir must also be expanded. The intent is to expand the capacity of the reservoir to meet the City's current and future ten-year needs.

The first phase of this project was the reservoir expansion at the existing facility; this work was completed in 2008. The engineering services contract was awarded to AECOM in the spring of 2010 and has been progressing to date. Currently, the consultant has been working toward water source selection, civil site design and access, as well as preparing to tender for membrane selection. Once the membrane supplier has been selected, the detailed design can occur.

As the design and planning stage has progressed throughout 2010, the updated construction cash flow is as follows:

2010 Year to Date	\$383,577
2011 Detailed Design Continued	\$967,509
2012 Water Treatment Phase I	\$10,202,556
2013 Water Treatment Phase II	\$9,474,410
2014 Post Construction Fees	<u>\$75,000</u>
	\$21,103,052
	( Estimate)

#### Budget

The annual budget allocation presented is based on the assumption that the water treatment stage of this project will be phased over two years. Also included in the budget for 2011 is funding to upgrade the raw water intake at Pumphouse No. 1. The Department of Public Works & Engineering has completed an evaluation that indicates that the water from Yellowknife Bay is a safe and viable source for potable water. However, when this option was brought forward to the general public it met with a great deal of resistance. The public perception is that, as long as there is a risk associated with the remediation of Giant



## CAPITAL FUND - 2012 Capital Projects

---

Mine, the water of Yellowknife Bay is not a suitable source regardless of its quality. The City of Yellowknife will continue to use the existing submarine pipeline while looking for methods to replace the pipeline with minimal financial impact. Also, given the complexity of the work, it is anticipated that the commissioning and final preparatory work of the water treatment equipment will take place during the first quarter of 2014.

The City's current funding arrangement is shown below:

2010 Carryover	\$7,050,000
2011	\$1,604,000
2012	\$5,823,000
2013	\$5,290,000
<u>2014</u>	<u>\$1,500,000</u>
Project Total	\$21,267,000

The City will be making an application for funding from the GNWT and the federal government, as the total cost of the water treatment plant could be in the \$20 million range.

This project works toward meeting City Council's Objective #2.3<sup>1</sup>.

### O&M IMPACT

There would be no significant change in O&M costs or staff time for the pumphouse. However, operating costs will increase with addition of treatment estimated at \$70,000 (3% capital) per year. When the plant is fully operational the Water Treatment Plant Operators while on duty must concentrate only on their O&M tasks associated with the WTP and they will not be able to provide any dispatch services during their shifts. In conjunction with the commissioning of the new WTP a separate stand-alone dispatch unit must be set up to provide and maintain the level of service residents have

come to expect from the City of Yellowknife. Public Works & Engineering and Public Safety are currently working to determine the staffing requirements and associated costs.



Water Treatment Plant

---

<sup>1</sup> Develop smart and sustainable approaches to energy, water and sewer, waste management, and building systems.



## CAPITAL FUND - 2012 Capital Projects

---

**DEPARTMENT** PUBLIC WORKS & ENGINEERING

**DIVISION** PUMPHOUSES/LIFTSTATIONS

**PROJECT** Liftstations - Capital Upgrades

**COST**

2012	\$65,000
2013	\$65,000
2014	\$65,000

**PHASE** Ongoing

**DESCRIPTION** The City has 11 sewage liftstations to move sewage from people's homes to the sewage lagoon. The value of the liftstations is around \$30,000,000. The Niven Lake liftstation was added in 2006 in order to match continued development. Like the pumps located in the pumphouses for the potable water supply, the pumps and sewage grinders in the liftstations must also be maintained and replaced at regular intervals.

If pumps or grinders fail, a sewage overflow can result. This has occurred in the past and a backup has resulted in sewage entering people's homes. In 2003, a sewage overflow at Liftstation #6 cost the City \$25,000 for remediation. On another occasion, sewage backed up in a number of downtown homes due to the grinder not working to capacity.

The average costs to rebuild or replace a pump and a comminutor (sewage grinder) are \$20,000 and \$30,000 respectively. The cost to replace a comminutor is \$80,000. Larger pumps in Liftstations #5 and #6 cost between \$30,000 and \$40,000 to replace.

The high number of components and the high cost of repairs justify the existence of a capital expenditure that can be allocated in the sewage liftstations.

Many of the City's liftstations are aging and require increased architectural care and maintenance. These buildings have aged cladding and inefficient windows, and it is suggested that insulation and windows be upgraded to reduce heating costs. This, in conjunction with new siding and roofing, will reduce operating costs for the buildings, which will blend better with the surrounding neighbourhood.

This project works towards City Council's Goal #2.3<sup>1</sup>.

### O&M IMPACT

There will be a reduction in call-outs and sewer spills as well as power consumption. Rebuilding and/or replacing the pumps and sewage grinders will increase the life of the City's sewage liftstations. This will reduce heating costs, as well as removing the need to paint every three to four years.

---

<sup>1</sup> Develop smart and sustainable approaches to energy, water and sewer, waste management, and building systems.



Wet well



Grinder



Sewage Pump



## CAPITAL FUND - 2012 Capital Projects

---

**DEPARTMENT** PUBLIC WORKS & ENGINEERING  
**DIVISION** WATER & SEWER  
**PROJECT** Pumphouse Reservoir - Flushing, Cleaning and Repairs  
**COST** 2012 \$25,000 – Pumphouse #3  
2013 \$25,000 – Pumphouse #4  
2014 \$60,000 – Pumphouse #1

**PHASE** Ongoing

**DESCRIPTION** The City has three water storage reservoirs that provide potable water to our residents, as well as firefighting capabilities. The City's Water Licence N1L3-0032 was renewed with a condition that the main reservoir be cleaned. Under operational compliance, the City should flush the main reservoir at Pumphouses #3 and #4.

Flushing the reservoir requires advanced planning and management. The process includes draining the reservoir, removing and disposing of the sediment, and disinfecting the interior of the reservoir, all while maintaining a continuous water supply to the City. An additional requirement during the flushing is to evaluate the walls and grout small cracks.

Public Works & Engineering recommends the flushing, cleaning and repair of the City's water reservoirs once a year on a three-year cycle as there are three reservoirs.

This project works toward meeting City Council's Goal #2.3<sup>1</sup>.



**O&M IMPACT** Less debris in the reservoir will add to the effectiveness of the chlorine added to the water. This will increase the free chlorine residual and in turn reduce the quantity of chlorine required for disinfection. Additional savings will occur once the cracks are filled and leaks abated.

---

<sup>1</sup> Develop smart and sustainable approaches to energy, water and sewer, waste management, and building systems.

## CAPITAL FUND - 2012 Capital Projects

---

**DEPARTMENT** PUBLIC WORKS & ENGINEERING  
**DIVISION** PUMPHOUSES/LIFTSTATIONS  
**PROJECT** Pump Replacement for Pumphouses and Liftstations

**COST** 2012: \$100,000  
2013: \$100,000

**STATUS** Ongoing

**DESCRIPTION** The City's water and sewage pumping stations (pumphouses and liftstations) along with water and sewer pipe networks, make up its water distribution and sewage collection system. Most of these stations were built or upgraded from the early 1970s to the early 1980s and are now 25 to 35 years old. Many of the City's 50 water and sewage pumps, which are the most important pieces of equipment within the stations, have been upgraded over the past five years but require increased maintenance to maintain a high level of efficiency. In fact, some of the pumps replaced in 2003 had worn-out impellers. Without their replacement it is unlikely that the City would have been able to supply enough water to the residents. Pump rebuilding costs about \$7,000 to \$25,000 per pump, while replacing costs \$10,000 to \$35,000 per pump. At times, because of the poor conditions of pumps, it is more cost-effective to replace with new pumps rather than to rebuild. A new standard for electric motors has been determined by Water & Sewer. The new motor specification is more efficient and capable of upgrades to variable-frequency drive in the future. Public Works & Engineering staff continues to work to improve efficiency of the water and sewer service and increase maintenance standards to provide a high level of service to residents.

Based on standard industry procedure and the experience of Public Works & Engineering staff, a rule of thumb is that pumps are to be replaced after

approximately 25 years of operation. There are 17 water and sewage pumping stations in the city, and each station has between two and nine pumps. These pumps were installed at different times, so their replacement dates will be spread out. Levels of maintenance have also increased to ensure efficiencies are of the highest possible level and, in many instances, specialized personnel and equipment must be utilized to do so.

It is therefore recommended that this capital replacement program continue for the water and sewage pumps at the City's pumping stations. An inefficient pump raises costs and creates greenhouse gas emissions.

Public Works & Engineering estimates that the total replacement value of the pumps is approximately \$1.6 million and proposes to spend about \$100,000/year for pump replacements and monitoring to continue the orderly replacement of pumps that are in poor condition.

It is recommended that the aging, diesel-driven fire pump at Pumphouse #4 be replaced in 2012. This pump is approximately 30 years old and is necessary to sustain proper fire flows in the Frame Lake/Range Lake area. Additionally, this pump has the capability to push flow back to the downtown core, in case of a widespread emergency situation. Due to the age of the pump, repairing and replacing parts is difficult and time-consuming to source. This is a larger project and will require increased funding due to the nature of the replacement.

Replacements for the future are:

**2012** Upgrade the aging diesel drive fire pump at Pumphouse #4.



- 2012** Upgrade electronics and other pump components to allow for better operation; schedule to be developed on a priority basis.
- 2013** Upgrade electronics and other pump components to allow for better operation; Schedule to be developed on a priority basis.

This project works toward City Council's Goal #2.3<sup>1</sup>.

### O&M IMPACT

Generally, newer pumps are more efficient requiring less energy to run. O&M funding should decrease as a result. Utility costs will be reduced and call-outs to check on failed pumps will also be reduced. Less stress on staff from having to be on the last redundant pump to keep the system supplied with water will result in a happier and more productive work environment.



---

<sup>1</sup> Develop smart and sustainable approaches to energy, water and sewer, waste management, and building systems.

## CAPITAL FUND - 2012 Capital Projects

---

<b>DEPARTMENT</b>	<b>PUBLIC WORKS &amp; ENGINEERING</b>
<b>DIVISION</b>	<b>WATER &amp; SEWER</b>
<b>PROJECT</b>	<b>Monitors and Controls Assessment of Pumphouses and Liftstations Upgrading</b>
<b>COST</b>	2012 \$75,000 2013 \$75,000 2014 \$75,000
<b>STATUS</b>	New
<b>PHASE</b>	Ongoing
<b>DESCRIPTION</b>	<p>In a three-phase program in 1997 through 2000, the City began automating all of its pumphouses and liftstations. In addition, the City installed a dedicated communication line to interconnect its most crucial facilities to avoid the characteristic interruptions of a telephone line. Many parts are now obsolete and, with the advancement of computer technology, some replacement parts are not made anymore and upgrades are required.</p> <p>The automation of these stations used for the delivery of essential services reduced operator time and increased system reliability. The City implemented a Supervisory Control and Data Acquisition (SCADA) computer system as the network controller of the system. The main computer for the SCADA system is located in Pumphouse No. 1. As a result of the automation, this is the only station that is staffed twenty-four hours per day. All alarms and system feedback are received on the SCADA computer in Pumphouse No. 1, which is the centre for emergency dispatch, and automation is required to relieve operators of hands-on requirement. Emergency dispatch is now their primary function.</p>

In order to ensure effective upgrades and maintenance to the City's SCADA monitors and controls, an assessment of the current system needs to be performed. This assessment will evaluate the monitors and controls employed in the system and the system deficiencies as well as recommended improvements to the system.

Implementing the findings of this assessment is the second part of this project, and was initiated in 2007 and will continue through 2014. To date, numerous shortcomings in the monitoring and controls system have been resolved and new infrastructure is being put in place that increases its efficiency.

The City's new water treatment plant project will be the hub for the City's SCADA system. The upgrading that has been underway since 2008 will ensure up-to-date equipment and an easy transition when the water treatment plant comes online.

This project works toward City Council's Goals #2.3<sup>1</sup>.

### O&M IMPACT

This assessment and upgrade will effectively increase the efficiency of the system and reduce operational maintenance by reducing the number of call-outs.

With the proper repair of the SCADA system, Water & Sewer trades workers will be able to reduce building inspections and spend more time repairing worn components.

Implementation of new water quality monitors will relieve the need for weekend rounds and increase water quality compliance ability and public expectations.





- 
- <sup>1</sup> Develop smart and sustainable approaches to energy, water and sewer, waste management, and building systems.



## CAPITAL FUND - 2012 Capital Projects

---

**DEPARTMENT** PUBLIC WORKS & ENGINEERING

**DIVISION** WATER & SEWER (PUMPHOUSES & LIFTSTATIONS)

**PROJECT** Pumphouse & Liftstation Pipe Replacement

**COST**  
2012 \$325,000  
2013 \$300,000  
2014 \$300,000

**STATUS** Ongoing

**DESCRIPTION** The age of our infrastructure is such that the City will have to rebuild the piping of a pumphouse or liftstation yearly to avoid catastrophic failure. In a study performed by AD Williams Engineering in 2004, it was determined that inspected pipes of the two buildings were only 40% to 70% the thickness of new pipes. Small leaks are occurring regularly in these buildings. The combination of leaking pipes and electricity poses a danger to workers.

Liftstation #5 is the main liftstation for the City. All but one of the other liftstations in the city pump sewage to Liftstation #5, and from there it is pumped to Fiddler's Lake Lagoon. With nine liftstations pumping to Liftstation #5 it is very important that it functions at peak operating performance. Shutdowns for unplanned repairs are not viable. Overflow sewage goes into Kam Lake. There are not enough trucks in the city to haul the sewage to the lagoon, should a break occur.

The pipe at Liftstation #5 has deteriorated over time to the point that it is now 40% of its original thickness. Average thickness at elbow bends is 50% of original thickness and most straight run pipes are 60% to 65% of original thickness. Leaks require repair approximately every two months. Should pipe replacement not be completed, it is inevitable that a main pipe break will occur resulting in the City being

unable to remove sewage.

This works toward City Council's Goals #2.3<sup>1</sup>.

**O&M IMPACT** The welded pipe will be replaced with Victaulic-style connectors. Replacement pipe will be coated with epoxy paint to prolong its life cycle. Future repairs may be done by City crews at significant cost savings.

---

<sup>1</sup> Develop smart and sustainable approaches to energy, water and sewer, waste management, and building systems.



**CAPITAL FUND - 2012 Capital Projects**

---

**DEPARTMENT PUBLIC WORKS & ENGINEERING**

**DIVISION WATER & SEWER**

**PROJECT Water Meter Replacement and Upgrade**

**COST**  
 2012 \$15,000  
 2013 \$25,000  
 2014 \$25,000

**STATUS Ongoing**

**PHASE Ongoing**

**DESCRIPTION** The City introduced a water meter replacement program in 1995, starting with the replacement or recalibration of the larger commercial units within the City. The remaining old meters were installed in the 1970s, more than 30 years ago.

The aging meters cause operational and maintenance inefficiencies, as well as inaccurate readings which account for an estimated 12-25% lost revenue to the City. The Corporate Services Department has actually identified a number of accounts with increased revenue after new meters were installed. In addition, unlike the newer meters installed today, old meters are not compatible with the latest computerized meter reading and data processing technology.

Upgrading to computerized water meters and meter reading devices will reduce labour requirements for meter reading and data entry into the City's computer system. Also, the new meters have the capability to be upgraded to remote meter reading. Should this be implemented, further reduced meter reading and data processing labour would result.

The City has successfully removed all pin-type water meters. The next step is to change all the visual-type

water meters. There are currently 306 visual water meters remaining, excluding Northland Trailer Park.

Meters lose efficiency with age and continued upgrading is necessary. Providing a budget in 2012, 2013 and 2014 will allow the replacement or upgrading of larger size meters and older 5/8" meters.

In 2012, the City wishes to continue upgrading the older 5/8" meters and researching remote meter reading technology.

This replacement plan is intended to bring the City up to par with other major municipalities across Canada.

This project works toward meeting Council's Goals #2.3<sup>1</sup>.

**O&M IMPACT**

Reduced labour requirements for meter reading and data processing. Increased revenue well above the cost of meter replacement.

---

<sup>1</sup> Develop smart and sustainable approaches to energy, water and sewer, waste management, and building systems.

## CAPITAL FUND - 2012 Capital Projects

---

**DEPARTMENT** PUBLIC WORKS & ENGINEERING

**DIVISION** WATER & SEWER

**PROJECT** Fire Hydrant Repair/Upgrading

**COST**

2012	\$30,000
2013	\$30,000
2014	\$30,000

**STATUS** Ongoing

**DESCRIPTION** The City maintains 320 fire hydrants. The hydrants are used in emergency situations to fight fires, but are also a source of water in the event sections of water piping become damaged. The underground pipe can be shut off and the system connected above ground, one hydrant to the next, to maintain circulation on the system and prevent freezing.

The Municipal and Community Affairs Standard for Community Works states that each hydrant should be inspected and rebuilt every six years. Each year, Public Works & Engineering inspects all fire hydrants in the city during the annual water main flushing program. At this time a list of defective or damaged hydrants is established and maintenance is facilitated accordingly. There are approximately 55 hydrants that will be repaired or upgraded annually. By maintaining the standard, the City protects residents and itself from fires, mishaps and lawsuits arising from non-functioning hydrants.

Maintenance work includes removing the hydrant, dismantling, and inspecting it, then replacing worn or non-functional parts. Upgrades are also performed on the hydrants to make them more reliable in winter operation. In vaults that are susceptible to flooding, plugs are installed to stop water from entering through a drain hole. This water would freeze and render the

hydrant inoperative. Metal bearings are replaced with Teflon busing to give the hydrant a “thermal break” which helps to prevent the transfer of cold from air to water and cause freezing of otherwise moving parts.

A new hydrant vault will increase ease of future maintenance and eliminate service disruption due to currently high maintenance requirements.

This project works toward meeting City Council's Goals #2.3<sup>1</sup>.

### O&M IMPACT

Emergency repairs proceed more smoothly because valves and hydrants work properly. There are fewer emergency calls because of faulty hydrants. Should there be a fire, all persons on the Water and Sewer crew have the ability to repair a hydrant in an emergency.



---

<sup>1</sup> Develop smart and sustainable approaches to energy, water and sewer, waste management, and building systems.



**CAPITAL FUND - 2012 Capital Projects**

---

**DEPARTMENT** PUBLIC WORKS & ENGINEERING

This works toward Council’s Goal #4.1<sup>1</sup>.

**DIVISION** Water & Sewer

**O&M IMPACT**

No impact to O&M. The majority of this work will be done on a consultant basis.

**PROJECT** Water Licence Study and Report Requirements

**COST**  
 2012 \$100,000  
 2013 \$50,000  
 2014 \$25,000

**STATUS** New

**DESCRIPTION** In May 2010, the City’s water licence was renewed. The new licence has a 12-year duration, beginning May 31, 2010 and ending May 30, 2022.

The new licence requires the City to perform studies, create management plans and compile reports for the Fiddler’s Lake Sewage Lagoon and the Solid Waste Facility. These items are to be submitted intermittently over the next four years, with the majority of the work to occur in 2011.

The projects required at the Solid Waste Facility include investigation into background metal concentrations in the area surrounding the landfill and an evaluation of the discharge area for treated water from the lagoon at the Contaminated Soil Treatment Facility.

The projects required for the Fiddler’s Lagoon include a Lagoon Treatment System Management Plan, comparison of effluent quality and lagoon performance with the CCME Canada-wide Strategy for the Management of Municipal Wastewater Effluent, and evaluations of three site-specific parameters.

In order to maintain compliance with the terms of the current water licence these studies, reports and management plans must be undertaken and submitted within the given timeframes.

---

<sup>1</sup> Be accountable to residents by ensuring open and accessible information flow and accessible decision making.

## CAPITAL FUND - 2012 Capital Projects

---

<b>DEPARTMENT</b>	<b>PUBLIC WORKS &amp; ENGINEERING</b>
<b>DIVISION</b>	<b>WATER &amp; SEWER (PUMPHOUSES &amp; LIFTSTATIONS)</b>
<b>PROJECT</b>	<b>Pumphouse #4 Sodium Hypochlorite Generation</b>
<b>COST</b>	<b>2012 \$400,000</b>
<b>PHASE</b>	<b>Ongoing</b>
<b>DESCRIPTION</b>	<p>Federal drinking water regulations require all potable water in Canadian communities to be disinfected to remove harmful pathogens that can occur naturally in water sources.</p> <p>Currently, the City's main form of potable water disinfection is chlorination via chlorine gas at Pumphouses #1 (School Draw) and #4 (Old Airport Road) and sodium hypochlorite at #3 (Reservoir Road).</p> <p>Public Works wishes to move towards on-site sodium hypochlorite generation at all pumphouses. Sodium hypochlorite is already in use at Pumphouse #3, in a diluted (12%) solution state and is received in that form.</p> <p>The main reason for this direction is employee and public safety. Chlorine gas is a very volatile and dangerous substance. If a cylinder of chlorine gas were to be compromised, it could have lethal effects. As mentioned, chlorine gas is in use at Pumphouses #1 and #4, which are directly adjacent to many homes, and prominent City facilities such as the Multiplex and Fieldhouse. Stanton Territorial Hospital is also close to Pumphouse #4. Eliminating the need to handle and install these cylinders will greatly reduce risk to employees and the surrounding environment.</p> <p>Sodium hypochlorite generation is a process that many municipalities are implementing. On-site generation can solve supply issues and shipping/handling costs. The</p>

City would then be able to supply each facility with the required amount of disinfectant without having to import it from another source.

Costs at this stage are estimated to be neutral with gas cylinders, but considering the increased safety factor and the need for disinfection, it is the direction in which the City should be moving .

This project works toward Council's Goals #2.3<sup>1</sup> .

### O&M IMPACT

The impact will be minimal considering the care and attention that is required with the chlorine gas cylinders. There will be operational requirements necessary to generate the sodium hypochlorite, at this stage; this can be handled by current staff.

---

<sup>1</sup> Develop smart and sustainable approaches to energy, water and sewer, waste management, and building systems.



**CAPITAL FUND - 2012 Capital Projects**

---

<b>DEPARTMENT</b>	<b>PUBLIC WORKS &amp; ENGINEERING</b>
<b>DIVISION</b>	<b>WATER &amp; SEWER</b>
<b>PROJECT</b>	<b>Personal Gas Monitoring Equipment Upgrade</b>
<b>COST</b>	<b>\$30,000</b>
<b>STATUS</b>	<b>New</b>
<b>DESCRIPTION</b>	<p>In order to ensure the safety of City personnel while performing tasks essential to maintaining the City's water and sewer system and other facilities, we must provide them with the equipment to do so.</p> <p>The City places the highest level of importance on the safety of our employees and residents. To ensure the safety of our residents, confined space entry is an essential aspect of our daily operations as we complete quality testing, monitoring and maintenance of various facilities. Confined space entry can be hazardous, so it requires all staff to comply with WSCC and local regulations. One such regulation is to perform atmospheric testing prior to and during all entries.</p> <p>The gas monitoring equipment currently owned and maintained by the City has become obsolete. Over the next two to five years, parts and sensors for this equipment will no longer be available. The safety of our staff must take priority as we move forward with this essential safety technology.</p> <p>This works toward Council's Action #4(c)<sup>1</sup>.</p>
<b>O&amp;M IMPACT</b>	Increased worker safety and comfort, which reduce sick leave and the health effects of noxious gases, are high priorities.

---

<sup>1</sup> Become a preferred employer.

## CAPITAL FUND - 2012 Capital Projects

---

DEPARTMENT	PUBLIC WORKS & ENGINEERING
DIVISION	WATER & SEWER
PROJECT	Water & Sewer Infrastructure Replacement Corrugated Metal Pipe (CMP) Replacement Program
COST	2012: \$2,225,000 2013: \$2,700,000 2014: \$3,800,000
STATUS	Replacement
PHASE	Program initiated in 1984 and is ongoing
DESCRIPTION	<p>The water and sewer capital projects are part of the ongoing replacement of deteriorated water and sewer mains, and upgrading of residential water and sewer services.</p> <p><b>Background - The Development of the City's Water &amp; Sewer Infrastructure</b></p> <p>The majority of the city is on piped water and sewer service with the exception of Old Town, Latham Island, Kam Lake Industrial Park, commercial buildings at the Airport, and some commercial buildings along Old Airport Road.</p> <p>In the late 1940s, the City began providing piped water and sewer services in the present downtown area. Pumphouse 1 was constructed during this time to draw water from Great Slave Lake and distribute water to downtown residents.</p> <p>Expansion of the City through the 1950s and 1960s was predominantly in the downtown area later referred to as the Central Business District (CBD). In the later 1960s, the expansion had reached the area of 50A Avenue and 57<sup>th</sup> Street.</p>

The city continued to obtain its water directly from Great Slave Lake until runoff and windblown arsenic resulted in high arsenic levels in the water and lake bottom sediments. In 1969, a new water intake line was constructed from the mouth of the Yellowknife River to Pumphouse 1. The submarine line is still in use and is a good example of Yellowknife's aging infrastructure requiring major work in the future. The estimated cost of replacement of the water intake line is about \$5 million.

There was considerable expansion during the 1970s. The early 1970s saw the development of Matonabee/Gitzel streets and construction along Forrest Drive. Pumphouse 3 was constructed in 1970 to serve the new areas of the city. In 1976, development began in Frame Lake South in the area of Bromley Drive and Williams Avenue. To supply water to this area, Pumphouse 4 was constructed in 1978 to serve Frame Lake South and Range Lake North areas. Pumphouse 4 has a capacity of servicing 10,000 people, and currently serves about two-thirds of the capacity.

In the 1980s, expansion of the city was generally in Frame Lake South. In the 1990s, expansion was generally in Range Lake North. Pumphouse 5, the recirculation pumphouse, was built in 1989 and serves as a recirculation station which simply keeps the water moving to avoid freezing for the Range Lake Area.

Expansion in 2005 to 2022 for residential development is envisioned to be in Niven Lake and Tin Can Hill.

### Water and Sewer Replacement Program

Water and sewer mains and services in the downtown core of the City were installed in the 1940s and 1950s. By 1977, the sewer mains had degraded to a point of failing entire sections of the City's piped system. This jeopardized the provision of reliable and safe water and sewer services for a significant part of the city.



Corrugated metal pipe (CMP) sanitary sewers were first installed in Yellowknife in the 1940s and continued to be used until 1977. After 1977, ductile iron pipe became widely available as a viable and cost-effective alternative. CMP was considered feasible at the time due to its ability to withstand deformations resulting from permafrost deformation or freeze/thaw ground movements, its low economic cost, and its ability to withstand the necessary freighting from Edmonton to Yellowknife. However, infrastructure replacement programs have revealed that CMP used in the 1940s is badly corroded and, in some cases, the bottom half of the pipe is no longer intact. Sewers without bottoms will sometimes collapse, resulting in the blocking of the pipe, and causing sewage to back up into the homes of residents. Sometimes sewage will travel into the surrounding environment, which results in high groundwater infiltration and gravel/soil accumulation in sewers. This, in turn, taxes the City's remaining infrastructure.

Cast iron water mains were installed at the same time as the CMP sanitary sewers from the 1940s to the early 1970s. These cast iron water mains are uninsulated and, as a result, substantial thaw settlement has occurred in areas with permafrost. This caused pipes to pull apart at the joints and sudden failure of the mains in some locations. The uninsulated mains necessitated substantial heating of the water to prevent freezing of the water mains. Finally, the water mains originally installed were not large enough, in many cases, to support up-to-date levels of fire protection.

The useful life of the CMP sewers, installed during the 1940s through the 1970s, has been found to be about 25 to 30 years. In 1984, a program was initiated by the City to replace all of its deteriorated water and/or sewer piping in the downtown core. As this was far beyond the City's financial capabilities, the GNWT funded a significant portion of the replacement costs annually. Since 1984, the City, along with GNWT cost-sharing, has

spent nearly \$23 million. An estimated \$7 million is required to complete the CBD area for piping infrastructure. A substantial amount of CMP sewer and cast iron water mains lies outside of the CBD and also needs to be replaced.

With the ongoing replacement programs continuing today, the City changed the standard to more modern materials such that the water mains are now insulated ductile iron pipe and the sewer mains are ductile iron. With the newer materials and standard installation construction practices, the life expectancy of water and sewer pipes can be as much as 50 years, although the actual life of a particular pipe will vary depending on the area of town where the water and sewer infrastructure is located. In Yellowknife, we have three different types of terrain: rock, granular native material, and frost susceptible soils. One should use caution in assuming life expectancy because some areas of the City have inferior ground conditions (frost susceptible soils) which will shorten life expectancies.

Typically, the driving force for the replacement of the water and sewer mains has been the perforated corrugated metal pipe sewer lines which have collapsed. The replacement program consisted not only of replacing the sewer pipes but also, while the trenches are open, of upgrading the water mains and services to current standards and levels of installation.

Included in the annual Water & Sewer Upgrading Programs are the following:

1. Replacement of existing corrugated metal pipe sewer mains with ductile iron pipe.
2. Concrete sewer manholes.
3. Replacement of existing cast iron water mains with appropriately sized insulated ductile iron pipe.
4. Replacement of single heat traced copper service lines with a dual, insulated copper recirculating system.



5. Replacement of in-line hydrants and valves with hydrants and valves located in insulated, poured-in-place concrete vaults with manhole access.
6. Road stabilization and reconstruction with crushed rock backfill.
7. Completion of the project with concrete sidewalks and a paved roadway.

As part of its water/sewer infrastructure replacement program, the City also replaces single-line water services (both the heat trace type and Aquaflow). We suspect that a significant number of these are inoperative, leading to freeze-ups during the winter. Generally, when single-line services fail, a bleeder is installed to avoid freezing. Bleeders work by continually running water so it doesn't freeze. The water coming from the bleeders is wasted, and is a burden to the City's infrastructure. The bleeders and single-line water services will be replaced with dual-line insulated copper re-circulating systems. Sewer services will be repaired or replaced based on their condition as assessed by a camera inspection and/or field determination.

### 2012 Water and Sewer Replacement Projects

#### Matonabee Street and LS #2 Replacement (from Franklin Avenue to Frame Lake Trail)

During the summer inspection and maintenance it was observed that the pipe connections from the sewer main to Liftstation #2 (LS#2) were in very poor condition and could fail at any moment. This inspection information prompted a priority revision for the CMP replacement program. There is still a section of pipe on Matonabee Street that has not been replaced since 1978; this requires immediate replacement. In addition to this work, there are still several single-line water services that need to be upgraded to dual-line services combined with a circulation pump for freeze protection purposes.

#### Knutsen Avenue (Paving)

This work was completed under the 2011 program and will need to be resurfaced with concrete and asphalt.

### 2013 Water and Sewer Projects

#### Horton Crescent

Replacements have occurred on Horton Crescent on several occasions. Each one occasion was a specific repair, as opposed to a full replacement project, and there have been three different contractors working on this area over the last ten years. In the past two years alone, there have been significant deflections in the sanitary sewer pipe in the area which, in some cases, are causing residential services to pull completely out of the main. These mains have to be excavated and a new road base constructed to solidify this infrastructure.

#### Matonabee Street (Paving)

This work will be completed under the 2012 program and will need to be resurfaced with concrete and asphalt.

### 2014 Water and Sewer Replacement Projects

#### Con Road (54 Street to Rycon Drive)

This remains one of the older sections of CMP remaining in the downtown area of Yellowknife. Some work was completed near the 54<sup>th</sup> Street end of Con Road in 1993 but the limits of construction were limited at the time. City Administration will be attempting to coordinate the replacement of this infrastructure with large scale multi-family development that is currently being planned for the area.

#### Lanky Court

In September 2010, Public Works crews responded to the collapse of a section of sanitary sewer main in Lanky Court. After further investigation, it was



**CAPITAL FUND - 2012 Capital Projects**

---

discovered that this section of pipe had been repaired but the remaining pipe in the cul-de-sac was in poor condition.

Due to the steep grade on the pipe, Public Works estimates that this pipe will remain intact for another year until it can be replaced in 2012. There are also several private potable water services that will need replacement. This project will also be able to upgrade these lines and install proper freeze protection.

*Byrne Road*

In conjunction with the work to occur on Knutsen Avenue, it is prudent to proceed with the replacement of water and sewer services on Byrne Road. The services there support the hospital, the new GNWT Data Centre and many residences. The infrastructure under Byrne Road is also a high priority due to its age and has been a target for replacement for quite some time.

Once Byrne Road and Knutsen Avenue are complete, all that remains in the area is Bromley Drive. The City will have to replace a very large section of CMP pipe, single-line and potable water services, which will greatly reduce O&M costs, water wasting from bleeders and impacts on the lagoon system.

*Horton Crescent (Paving)*

This work will be completed under the 2013 program and will need to be resurfaced with concrete and asphalt.

Street	Replacement	CMP Estimate	Paving Estimate
Matonabee Street	2012/2013	\$1,500,000	\$1,200,000
Horton Crescent	2013/2014	\$1,500,000	\$750,000
Byrne Road	2014/2015	\$925,000	\$850,000
Lanky Court	2014/2015	\$900,000	\$300,000
Con Road	2014/2015	\$1,225,000	\$500,000
Bromley Drive	2016/2017	\$2,100,000	\$900,000
Forrest Drive	2017/2018	\$650,000	\$525,000
Finlayson Drive	2019/2020	\$2,100,000	\$1,700,000
Dagenais Drive	2020/2021	\$3,300,000	\$1,200,000
Franklin Avenue	2022/2023	\$3,500,000	\$3,300,000
<b>TOTAL</b>		<b>\$17,385,000</b>	<b>\$11,225,000</b>

These priorities are subject to change from year to year, depending on failures and deteriorating pipe conditions. Therefore, the section which has the highest probability of failure based on inspections will be placed higher in the priority queue. This is reviewed and evaluated on an annual basis.

CAPITAL FUND - 2012 Capital Projects

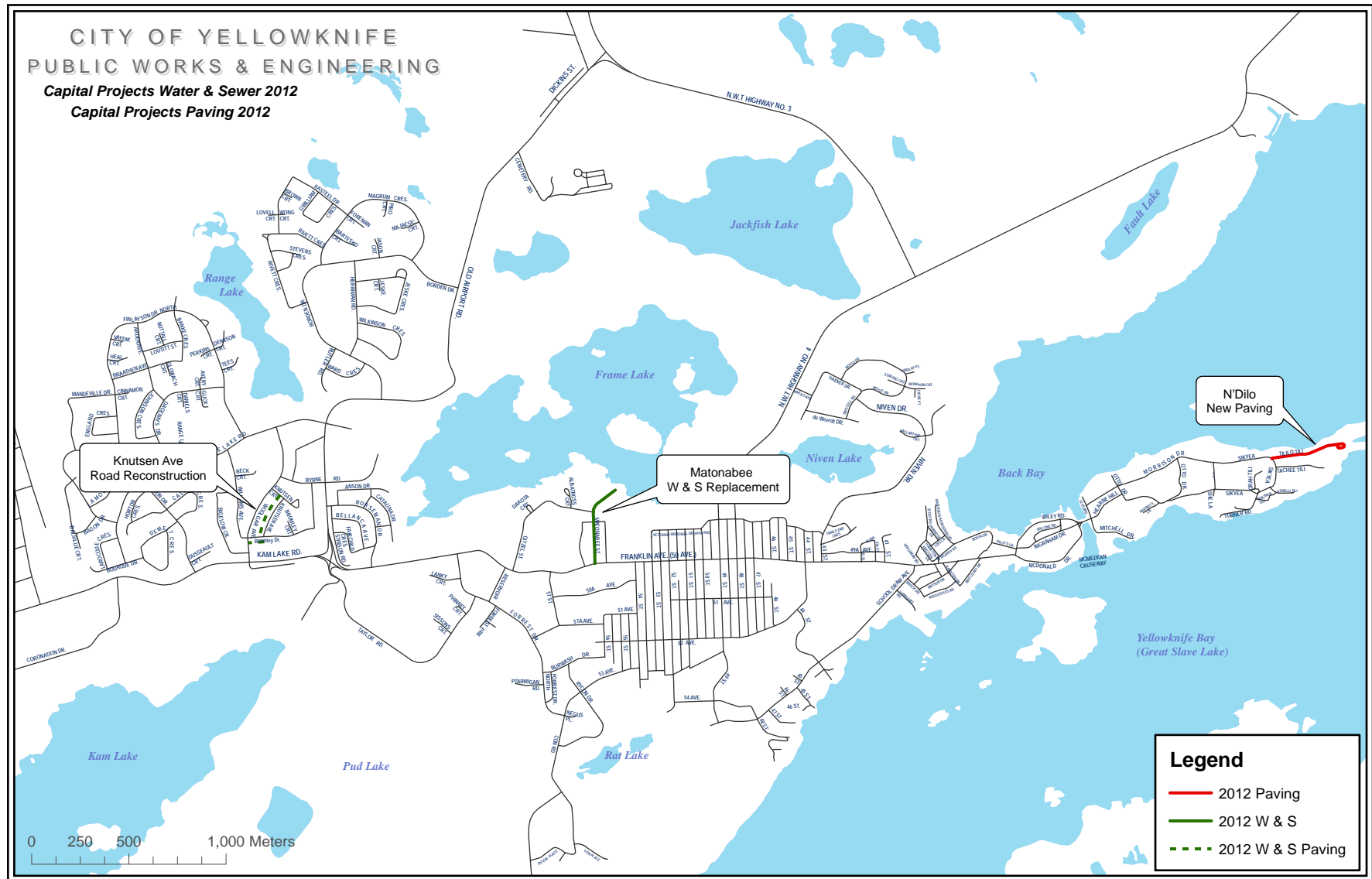

CAPITAL FUND - 2012 Capital Projects

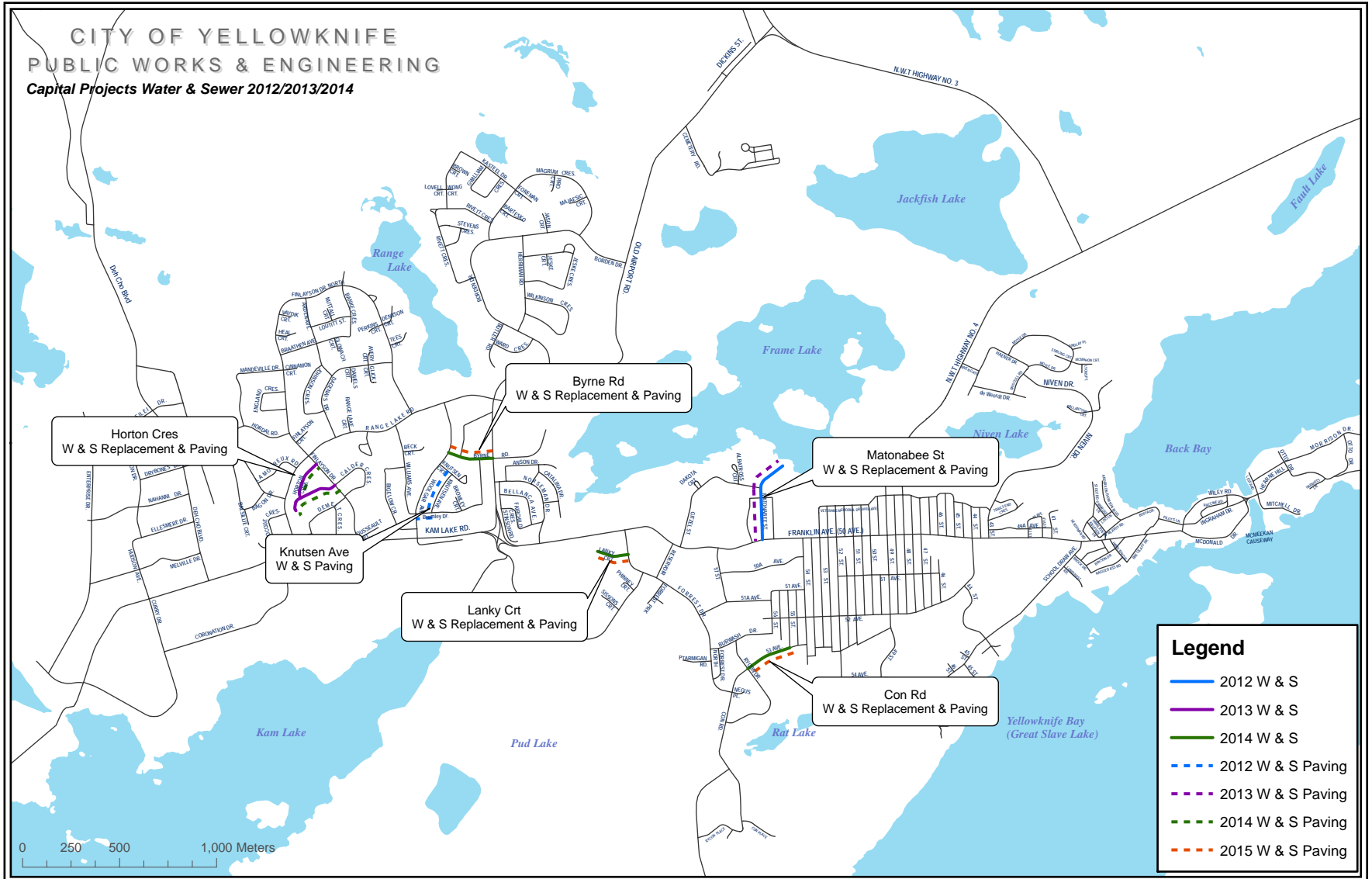

THIS PAGE LEFT BLANK INTENTIONALLY



**CAPITAL FUND - 2013 Capital Projects**

---

		<b>2013 Budget Recommended (\$000s)</b>	<b>Formula Funding (\$000s)</b>	<b>IT Reserve (\$000s)</b>
<b>General Government</b>				
	<b>Page</b>			
Tourism Marketing & Development	208	40	40	
		40	40	-
<b>Information Technology</b>				
Network Upgrades	209	25		25
GIS Enhancements	210	50		50
Server Replacement	211	25		25
Desktop Telephone Replacement	310	10		10
Satellite Imagery	311	75		75
Security Cameras	214	20		20
Secondary Site & Data Replication	215	10		10
Website Enhancements	216	15		15
Server Room Upgrades	312	25		25
Virtualization	218	40		40
Wireless Standardization	313	20		20
Development and Building Permit Automation	224	25		25
		340	-	340
<b>Subtotal</b>		380	40	340

## CAPITAL FUND - 2013 Capital Projects

---

<b>DEPARTMENT</b>	<b>CORPORATE SERVICES</b>
<b>DIVISION</b>	<b>INFORMATION TECHNOLOGY</b>
<b>PROJECT</b>	<b>Desktop Telephone Replacement</b>
<b>COST</b>	<b>\$10,000</b>
<b>STATUS</b>	<b>Replacement</b>
<b>PHASE</b>	<b>1 of 1</b>
<b>DESCRIPTION</b>	<p>Many of the City's desktop telephones are nearing the end of their life expectancies, and the Information Technology Division is noticing an increasing failure rate. Therefore it is recommended that the City plan to replace the approximately 30 remaining Toshiba units in 2013.</p> <p>This project works toward City Council's Goals #1<sup>1</sup> and #4<sup>2</sup>, Objectives #1.4<sup>3</sup> and #4.4<sup>4</sup>, and Action #4(b)<sup>5</sup>.</p>
<b>O&amp;M IMPACT</b>	<p>Desk set replacements are currently funded on an as-needed basis from the O&amp;M budget allocation. Therefore, replacing these end-of-life units as a coordinated initiative will reduce the O&amp;M requirements needed to purchase new ones on an ad hoc basis.</p>

---

<sup>1</sup> Affordability

<sup>2</sup> Continuous Improvement

<sup>3</sup> Emphasize fairness and transparency in financial decisions, program delivery and land assembly.

<sup>4</sup> Be a leader in innovation.

<sup>5</sup> Lead in innovation and best practices.



**CAPITAL FUND - 2013 Capital Projects**

---

**DEPARTMENT** CORPORATE SERVICES  
**DIVISION** INFORMATION TECHNOLOGY  
**PROJECT** Satellite Imagery  
**COST** 2013 \$75,000  
 2015 \$50,000  
**STATUS** Replacement  
**PHASE** Ongoing

**DESCRIPTION** Orthophotos – digital aerial photographs with uniform scale and minimal distortion – are an important part of a geographic information system (GIS) because they provide an accurate representation of the earth’s surface.

In 2006, the City began acquiring high resolution colour digital orthophotography and incorporating it into cityExplorer. It provides the base mapping for the City’s database, and its high spatial accuracy and resolution have made it a powerful and popular tool for both staff and citizens. For example, planners and engineers often use the imagery for planning the locations and scope of new construction and improvement projects, and taxation and assessment staff refer to the imagery to verify the existence of specific property improvements and developments. As well, the layer is often used for creating a variety of new information layers, and to help keep existing layers current and accurate.

To keep the imagery relevant and to provide a consistent visual legacy of the city, it is important to maintain these imagery acquisitions at frequent and regular intervals. Therefore, acquisitions are scheduled every two years. In order to make this more affordable, the Information Technology Division has partnered with the Airports Division of the GNWT to coordinate joint imagery collection and thus share costs.

**O&M IMPACT** This project works toward City Council’s Goals #1<sup>1</sup>, #3<sup>2</sup> and #4<sup>3</sup>, Objectives #1.4<sup>4</sup>, #3.3<sup>5</sup>, #3.4<sup>6</sup> and #4.4<sup>7</sup>, and Actions #4(a)<sup>7</sup> and #4(b)<sup>9</sup>.  
 This project does not directly impact O&M expenditures, but does enable City staff to work more efficiently and provide improved services.

---

<sup>1</sup> Affordability  
<sup>2</sup> Building Social Capital (Community Engagement)  
<sup>3</sup> Continuous Improvement  
<sup>4</sup> Emphasize fairness and transparency in financial decisions, program delivery and land assembly.  
<sup>5</sup> Improve community participation and volunteerism opportunities.  
<sup>6</sup> Promote heritage, culture, arts and other unique characteristics of Yellowknife to honour our past and preserve/showcase our history and cultural diversity.  
<sup>7</sup> Be a leader in innovation.  
<sup>8</sup> Develop a Customer Service Culture.  
<sup>9</sup> Lead in innovation and best practices.



## CAPITAL FUND - 2013 Capital Projects

---

**DEPARTMENT** CORPORATE SERVICES

**DIVISION** INFORMATION TECHNOLOGY

**PROJECT** Server Room Upgrades

**COST** \$25,000

**STATUS** New

**PHASE** 1 of 1

**DESCRIPTION** A significant portion of the City's information technology infrastructure is housed in its server room. As the City's dependence on technology increases, so do the demands on this room, particularly in terms of power, cooling, and monitoring requirements.

This project will evaluate the existing server room conditions and determine current and anticipated demands, then implement appropriate power and monitoring upgrades to ensure the facility continues to meet the increasing demands placed on it.

This project works toward City Council's Goals #1<sup>1</sup> and #4<sup>2</sup>, Objectives #1.4<sup>3</sup> and #4.4<sup>4</sup>, and Action #4(b)<sup>5</sup>.

**O&M IMPACT** There will be no direct impact on O&M expenditures.

---

<sup>1</sup> Affordability

<sup>2</sup> Continuous Improvement

<sup>3</sup> Pursue creative market partnerships to promote affordable living.

<sup>4</sup> Be a leader in innovation.

<sup>5</sup> Lead in innovation and best practices.



## CAPITAL FUND - 2013 Capital Projects

---

**DEPARTMENT** CORPORATE SERVICES

**DIVISION** INFORMATION TECHNOLOGY

**PROJECT** Wireless Standardization

**COST** \$20,000

**STATUS** Replacement

**PHASE** 1 of 1

**DESCRIPTION** The City's network undergoes regular, incremental improvements to sustain its functionality. This strategy has proven to be an effective way to grow and expand the network to meet increasing demands and expectations. However, there remains the occasional need for a more significant investment to enhance the infrastructure and thus it is recommended that in 2013 the City upgrade its wireless access points and bridges to address impending end-of-life scenarios, and standardize the equipment so makes and models are consistent at all locations.

This enhanced foundation will protect the City's existing investment in its network, and ensure the network is able to meet current and future demands.

This project works toward City Council's Goals #1<sup>1</sup> and #4<sup>2</sup>, Objectives #1.4<sup>3</sup> and #4.4<sup>4</sup>, and Action #4(b)<sup>5</sup>.

**O&M IMPACT** This project will not impact the O&M budget. However, if the upgrade and standardization are not undertaken, network reliability could be compromised.

- 
- <sup>1</sup> Affordability
  - <sup>2</sup> Continuous Improvement
  - <sup>3</sup> Emphasize fairness and transparency in financial decisions, program delivery and land assembly.
  - <sup>4</sup> Be a leader in innovation.
  - <sup>5</sup> Lead in innovation and best practices.

**CAPITAL FUND - 2013 Capital Projects**

		<b>2013 Budget Recommended (\$000s)</b>	<b>Formula Funding (\$000s)</b>	<b>Other Revenue (\$000s)</b>	<b>Grants (\$000s)</b>	<b>Twin Pine Hill Trail Reserve (\$000s)</b>
<b>Community Services</b>						
	<b>Page</b>					
<b>Arenas</b>						
Multiplex - Façade Repair	315	100	100			
Multiplex - Snow Melt Pit	316	40	40			
Multiplex - Painting DND Gymnasium & Lobby	317	60	60			
<b>Parks/Trails</b>						
Lakeview Cemetery Expansion	318	100	100			
Fencing - Cemetery & Ballparks	319	100	100			
Playground Equipment Replacement - Niven Beach	320	90	10		80	
Sport & Multi-use Fields Upgrade- William McDonald Middle School Field	240	130	130			
Trail Development - Old Airport Road, McMahon Frame Lake & Tin Can Hill	321	400	400			
Yellowknife Rotary Park - Trail Extension	322	80	80			
Twin Pine Hill Trail Development	241	150	15	50		85
<b>Pool</b>						
Locker Replacement	323	80	80			
<b>Subtotal</b>		<b>1,330</b>	<b>1,115</b>	<b>50</b>	<b>80</b>	<b>85</b>



## CAPITAL FUND - 2013 Capital Projects

---

**DEPARTMENT** COMMUNITY SERVICES

**DIVISION** FACILITIES

**PROJECT** Multiplex - Façade Repair

**COST** \$100,000

**PHASE** 1 of 1

**DESCRIPTION** The first phase of the Multiplex was completed in 2003, with the second phase reaching completion in 2005. It has become a hub of activity as a year-round facility, attracting thousands of visitors each year. The Multiplex is open 20 hours a day for 36 weeks of the year, and 16 hours a day for the remaining 16 weeks of the year.

When the facility was built, a decision was made to remove the curbing in the parking lot to stay within the project budget. As a result, the siding of the facility has been damaged by snow removal and falling ice. It is proposed that barricades be placed around the exterior of the building and that the damaged siding be replaced with new siding to keep the aesthetics of the facility intact, as well as other measures taken to reduce further damage.

This works toward Council's Goal #2<sup>1</sup>.

**O&M IMPACT** There is no O&M impact.



---

<sup>1</sup> Enhancing our Built Environment

## CAPITAL FUND - 2013 Capital Projects

---

**DEPARTMENT** COMMUNITY SERVICES

**DIVISION** FACILITIES

**PROJECT** Multiplex – Snow Melt Pit

**COST** \$40,000

**STATUS** Replacement

**PHASE** 1 of 1

**DESCRIPTION** The Multiplex was opened for business in 2003. In 2005 the second ice surface was completed and opened to the public. The facility is outfitted with a snow melt pit that utilizes waste heat from the ice plant to melt snow and ice removed from the ice surfaces during re-surfacing operations.

The piping currently used in the pit has met its life expectancy and has been repaired repeatedly. Since the original installation, the technology of this application has advanced significantly, which will be a benefit in terms of longevity.

The proposed project will see the replacement of the coils in the snow melt pit with new coils that are designed for a 25-year life span.

This project works toward Council's Goal #2<sup>1</sup>.

**O&M IMPACT** There will be no O&M impact.



---

<sup>1</sup> Enhancing our built environment.



## CAPITAL FUND - 2013 Capital Projects

---

**DEPARTMENT** COMMUNITY SERVICES  
**DIVISION** FACILITIES  
**PROJECT** Multiplex – Painting of DND Gymnasium & Lobby  
**COST** \$60,000  
**STATUS** Upgrade  
**PHASE** 1 of 1

**DESCRIPTION** The Multiplex opened in 2002. Its major focal points are the main lobby and the DND Gymnasium, and their rate of use is extremely high. Since the opening of the facility, there has been minor repair and patch work done to the walls, but it is now in need of major repainting to protect the integrity of the building.

The Multiplex gymnasium has served many sporting, cultural, fundraising, and family functions. The facility has had some minor repairs and will require a more thorough overhaul in 2013.

The lobby is the main greeting area for all users of the facility. It is also used by various organizations for registration and reception. It is proposed that the two areas of the Multiplex be painted to ensure they remain vibrant and aesthetically pleasing.

This project works toward Council's Goal #2<sup>1</sup>.

**O&M IMPACT** There will be no O&M impact.



---

<sup>1</sup> Enhancing our built environment.

## CAPITAL FUND - 2013 Capital Projects

---

**DEPARTMENT** COMMUNITY SERVICES

**DIVISION** FACILITIES

**PROJECT** Lakeview Cemetery Expansion

**COST** \$100,000

**STATUS** New

**PHASE** 1 of 1

**DESCRIPTION** Lakeview Cemetery has been in existence since the late 1940s. There are 15 to 20 interments annually, a number which has been steadily increasing over the past few years.

The active area of the cemetery covers approximately 17,500 square metres which, until recently, has been adequate for interments, including cremations and regular casket burials. In 2009, the area was expanded to the west, which entailed the removal of trees and the addition of topsoil. This expanded area used up the last of the easily accessible land mass, and it is now necessary to undertake the development of the area to ensure it continues to meet the interment needs of the community well into the future.

It is proposed to design, survey, and expand the cemetery in an efficient and effective manner. This will ensure an orderly expansion in appropriate phases that will take into account topography and landscaping of the site.

This will work toward City Council's Goal #2<sup>1</sup>.

**O&M IMPACT** There will be an impact on O&M as the area will need to be maintained as a Class 'A' park after its completion. The cost of this will be \$4.00 per square metre of park.

---

<sup>1</sup> Enhancing our built environment.



## CAPITAL FUND - 2013 Capital Projects

---

**DEPARTMENT** COMMUNITY SERVICES

**DIVISION** FACILITIES

**PROJECT** Fencing (Cemetery and Ballparks)

**COST** \$100,000

**STATUS** Upgrade

**PHASE** 1 of 1

**DESCRIPTION** The Community Services Department maintains more than 150,000 square metres of parkland within the city limits, much of which is enclosed by chain-link fence. Over the years, the fences have fallen in various locations due to a combination of age, damage, and vandalism.

It is proposed that the fences in the City of Yellowknife be upgraded and returned to a high standard of maintenance. This will help beautify the city, promote our facilities, and generate community well-being.

This project works toward Council's Goal #2<sup>1</sup>.

**O&M IMPACT** There is no direct O&M impact.

---

<sup>1</sup> Enhancing our built environment.



## CAPITAL FUND - 2013 Capital Projects

---

**DEPARTMENT** COMMUNITY SERVICES  
**DIVISION** FACILITIES  
**PROJECT** Niven Beach – Playground Equipment Replacement  
**COST** \$90,000  
**STATUS** Replacement  
**PHASE** 1 of 1  
**DESCRIPTION** Playgrounds have a life span of about 15 to 20 years and need to be replaced on an ongoing basis to best serve the community.

There have been multiple code changes and advances in play equipment over the past 20 years, and the new equipment is mostly hard plastic that endures well in our northern climate. Suppliers now recommend that all new playground equipment be constructed with plastics or powder-coated aluminum technologies.

In 2013, it is proposed that the playground equipment be replaced at Niven Beach. The equipment is a combination of steel and wooden structures that have deteriorated over the years. The equipment is used frequently by many citizens in the area.

The new playground equipment will stimulate children and encourage their mental and physical growth. This is an investment in the future of Yellowknife, and works toward Council's Goals #2<sup>1</sup> and #4<sup>2</sup>. A sports grant will offset almost 90% of the cost of this project.

<b>BUDGET</b>	
Equipment	\$90,000
<u>Less Grant</u>	<u>\$80,000</u>
<b>Total =</b>	<b>\$10,000</b>

**O&M IMPACT** There will be no financial impact as these playgrounds already exist and will need the same level of safety checking regardless of the age of the equipment.

---

<sup>1</sup> Enhancing our Built Environment.

<sup>2</sup> Building Social Capital (Community Engagement).



**CAPITAL FUND - 2013 Capital Projects**

---

<b>DEPARTMENT</b>	<b>COMMUNITY SERVICES</b>	
<b>DIVISION</b>	<b>FACILITIES</b>	
<b>PROJECT</b>	<b>Trail Design, Development &amp; Upgrade – Old Airport Road, Frame Lake, Tin Can Hill</b>	
<b>COST</b>	2013	\$400,000
	2014	<u>\$290,000</u>
		<b>\$690,000</b>
<b>BUDGET</b>	Old Airport Road	\$590,000
	McMahon Frame Lake Trail	\$ 40,000
	Tin Can Hill Trail	<u>\$ 60,000</u>
	<b>Total</b>	<b>\$690,000</b>
<b>STATUS</b>	<b>Upgrade &amp; New</b>	
<b>PHASE</b>	<b>1 of 1</b>	
<b>DESCRIPTION</b>	<p>In 2005, Council adopted the Integrated Parks, Trails &amp; Open Spaces Development study with the mission of creating an environmentally friendly park system that beautifies the City; meets the needs of residents, visitors and tourists; and encourages people to be active in the outdoors year-round. The study addressed the future needs of the city in terms of parks and trails.</p> <p><b>Old Airport Road</b>          The development of a multi-use trail in close proximity to what is commonly referred to as the “Airport Loop” will formalize a trail system that has been utilized by walkers, joggers, and cyclists for many years. The trail will approximate the road distance, but will provide a safer option than using the highway to traverse from Old Airport Road back to the city centre, the McMahon Frame Lake Trail, Niven Lake Trail, or the Yellowknife Ski Club.</p>	

It is proposed that the trail be designed and developed

to provide its many users with an alternative to using the road.

**McMahon Frame Lake Trail**

The McMahon Frame Lake Trail is the busiest of the trail systems in the City of Yellowknife. The current trail system is maintained on an annual basis by Community Services staff.

In 2009, a report entitled “Bicycle Routing for the City of Yellowknife” was completed. One of the recommendations of this report is that the trail be widened to address the issues of safety, access, and traffic congestion.

It is proposed that areas of the trail be widened as necessary to address these issues.

**Tin Can Hill Trail**

Tin Can Hill is within walking distance of a high number of Yellowknife residents as well as the downtown city core. With the completion of the School Draw housing development, there will be an even greater demand to provide recreational facilities in this area.

It is proposed that funding be used for the design and development of approximately 3 kilometres of trail system.

These projects work toward Council’s Goals #2<sup>1</sup> and #3<sup>2</sup>.

**O&M IMPACT**

The O&M will depend on the length of the trails. For every kilometre of trail developed, the O&M impact would be \$6,000 per annum.

---

<sup>1</sup> Enhancing our built environment.

<sup>2</sup> Building social capital (Community Engagement).

## CAPITAL FUND - 2013 Capital Projects

---

<b>DEPARTMENT</b>	<b>COMMUNITY SERVICES</b>
<b>DIVISION</b>	<b>FACILITIES</b>
<b>PROJECT</b>	<b>Yellowknife Rotary Park – Trail Extension</b>
<b>COST</b>	<b>\$80,000</b>
<b>STATUS</b>	<b>New</b>
<b>PHASE</b>	<b>1 of 1</b>
<b>DESCRIPTION</b>	<p>In 2003, the Yellowknife Rotary Club and the City of Yellowknife collaborated to build the Yellowknife Rotary Centennial Waterfront Park off School Draw Avenue. In 2005, a picnic shelter was completed and the boardwalk expanded. In 2006, a bandstand was added to the park, and in 2008, a further extension to the boardwalk was completed.</p> <p>Residents throughout the city use the park quite extensively, as it offers a good-quality green picnic area with an excellent view of the waterfront.</p> <p>In 2010, the walkway in the park was paved and a disabled ramp installed to allow access for disabled citizens.</p> <p>Currently, the trail stops after ½ kilometre of trail, and it is proposed that the boardwalk be extended around the marshlands to connect with an informal trail extending from Ragged Ass Road.</p> <p>This extension will include several lookouts along the trail onto the lake, and the informal trail will be upgraded to provide proper access.</p> <p>This project would meet City Council's Goals #2<sup>1</sup> and #3<sup>2</sup>.</p>

**O&M IMPACT** There would be an increase of about \$2,000 per annum in the cost of maintaining this trail system, including staff time and equipment.

---

<sup>1</sup> Enhancing our built environment.

<sup>2</sup> Building social capital.



## CAPITAL FUND - 2013 Capital Projects

---

<b>DEPARTMENT</b>	<b>COMMUNITY SERVICES</b>
<b>DIVISION</b>	<b>PROGRAMS</b>
<b>PROJECT</b>	<b>Ruth Inch Memorial Pool – Locker Replacement</b>
<b>COST</b>	<b>2013 \$80,000</b> <b>2014 \$80,000</b>
<b>STATUS</b>	<b>Replacement</b>
<b>PHASE</b>	<b>2013 1 of 2</b> <b>2014 2 of 2</b>
<b>DESCRIPTION</b>	<p>The Ruth Inch Memorial Pool has been open to the public since 1988. The pool operates an average of 16 hours a day for 48 weeks of the year. About 300 to 400 patrons visit the pool daily and the facility is used for a variety of activities. Pool users require lockers to store their personal belongings while they participate in their activities. The lockers are coin operated - the public can insert a coin to obtain a key to lock their locker. On average, the facility recovers about \$10,000 annually in locker revenue.</p> <p>Over the past 22 years, the high humidity, chlorinated air, and constant washing of these lockers have broken down the metal and they are beginning to rust. Some coin drop boxes are rusting to the point where they are difficult to open or lock.</p> <p>The plan is to replace the men’s lockers (2013) and the women’s lockers (2014). This project would replace the existing metal lockers with hard plastic lockers that will last the life of the building. These hard plastic lockers are available from the same supplier that installed the original lockers for the pool.</p>

This project works toward Council’s Goal #2<sup>1</sup>.

**O&M IMPACT** There will be no impact on the O&M. Resources that have been spent in the past to maintain the lockers will be redirected to other areas of the facility.



---

<sup>1</sup> Enhancing Our Built Environment.

CAPITAL FUND - 2013 Capital Projects

---

		2013 Budget Recommended (\$000s)	Formula Funding (\$000s)
<b>Public Safety</b>			
	<u>Page</u>		
<b>Fire &amp; Ambulance</b>			
Bunker Gear Lockers	325	60	60
Front Ramps and Site Improvements	326	150	150
<b>Subtotal</b>		<u>210</u>	<u>210</u>

		2013 Budget Recommended (\$000s)	Formula Funding (\$000s)
<b>Planning &amp; Development</b>			
	<u>Page</u>		
Smart Growth & Harbour Plan Initiatives	252	600	600
Streetscaping Initiatives (Downtown)	253	500	500
<b>Subtotal</b>		<u>1,100</u>	<u>1,100</u>



## CAPITAL FUND - 2013 Capital Projects

---

**DEPARTMENT** PUBLIC SAFETY

**DIVISION** FIRE AND AMBULANCE

**PROJECT** Bunker Gear Lockers

**COST** \$60,000

**STATUS** New

**PHASE** 1 of 1

**DESCRIPTION** An increase in Paid-On-Call firefighters has resulted in the need for more locker space. The fire hall expansion will open space in the apparatus bay to accommodate the additional bunker gear lockers, which will be consistent with the lockers currently used by other firefighters.

This project works toward City Council's Goal #4<sup>1</sup>.

**O&M IMPACT** Minimal

---

<sup>1</sup>Continuous Improvement

## CAPITAL FUND - 2013 Capital Projects

---

<b>DEPARTMENT</b>	<b>PUBLIC SAFETY</b>
<b>DIVISION</b>	<b>FIRE AND AMBULANCE</b>
<b>PROJECT</b>	<b>Front Ramps and Site Improvements</b>
<b>COST</b>	<b>\$150,000</b>
<b>STATUS</b>	<b>Replacement</b>
<b>PHASE</b>	<b>1 of 1</b>
<b>DESCRIPTION</b>	Repairs are required to the front ramp and portions of the foundation which have heaved, causing structural damage. This amount was originally allocated to the 2011 budget but was used to offset the cost of the Fire Hall expansion.  This project works toward City Council's Goal #4 <sup>1</sup> .
<b>O&amp;M IMPACT</b>	Minimal

---

<sup>1</sup> Continuous Improvement



**CAPITAL FUND - 2013 Capital Projects**

---

		<b>2013 Budget Recommended (\$000s)</b>	<b>Formula Funding (\$000s)</b>	<b>M.E.R. Reserve (\$000s)</b>	<b>MACA Capital Grant (\$000s)</b>
<b>Public Works &amp; Engineering</b>					
	<b>Page</b>				
<b>Fleet Management</b>	<b>329</b>				
1053-09 Crown Victoria B53		51		51	
1122-09 Bush Hog Professional Series M		15		15	
2019-96 Mobile Street Sweeper		367		367	
2033-07 Cat 140M Grader		204		204	
2100-01 Bobcat Loader Ingersoll		66		66	
2110-97 Ford E-350 Ambulance		179		179	
3129-04 Zamboni Model 440		123		123	
Fleet Total		<u>1,005</u>	<u>-</u>	<u>1,005</u>	<u>-</u>
	<b>Page</b>				
<b>Engineering &amp; Garage</b>					
Diagnostic, Safety Equipment & Specialty Tools For Mechanics	267	20	20		
Garage- Fire Code & Safety Improvements	268	50	50		
<b>Roads &amp; Sidewalks</b>					
Road Rehabilitation	269	2,622	412		2,210
Traffic Lights UPS	273	60	60		
Drainage Improvements	274	50	50		
New Bus Shelters & Route Posts	275	20	20		
		<u>2,822</u>	<u>612</u>	<u>-</u>	<u>2,210</u>



**CAPITAL FUND - 2013 Capital Projects**

	<b>Page</b>	<b>2013 Budget Recommended (\$000s)</b>	<b>Formula Funding (\$000s)</b>	<b>Water &amp; Sewer User Fees (\$000s)</b>	<b>M.E.R. Reserve (\$000s)</b>	<b>Gas Tax Rebate (\$000s)</b>	<b>MACA Capital Grant (\$000s)</b>
<b>Solid Waste Management</b>							
<b>Landfill</b>							
Baling Facility Mechanical Upgrades	278	25	25				
Site Restoration	279	150	150				
Centralized Composting Project	280	750	750				
		<b>925</b>	<b>925</b>	<b>-</b>	<b>-</b>	<b>-</b>	<b>-</b>
<b>Community Energy Plan (CEP) Initiatives</b>							
CEP Implementation	283	85	85			-	
Energy Efficiency Projects	283	415	415			-	
		<b>500</b>	<b>500</b>	<b>-</b>	<b>-</b>	<b>-</b>	<b>-</b>
<b>Pumphouses/Liftstations (PHs/LSs)</b>							
Water Treatment Plant	286	5,290		771		4,519	
Liftstations Capital Upgrade	289	65		65			
Reservoir Flushing, Cleaning & Repairs	291	25		25			
Pump Replacement Program	292	100	100				
Monitor & Controls Assessment & Upgrade	294	75	75				
Pumphouse & Liftstation Pipe Replacement	296	300	300				
<b>Other</b>							
Water Meter Replacement & Upgrade	297	25	4	21			
Fire Hydrant Repair/Upgrade	298	30	30				
Water Licence Study & Report Requirements	299	50	50				
<b>CMP Replacement Program</b>	<b>302</b>	<b>2,700</b>	<b>875</b>	<b>1,825</b>			
		<b>8,660</b>	<b>1,434</b>	<b>2,707</b>	<b>-</b>	<b>4,519</b>	<b>-</b>
<b>PW Subtotal</b>		<b>13,912</b>	<b>3,471</b>	<b>2,707</b>	<b>1,005</b>	<b>4,519</b>	<b>2,210</b>



## CAPITAL FUND - 2013 Capital Projects

---

<b>DEPARTMENT</b>	<b>PUBLIC WORKS &amp; ENGINEERING</b>
<b>DIVISION</b>	<b>FLEET MANAGEMENT</b>
<b>PROJECT</b>	<b>Upgrading of Fleet</b>
<b>COST</b>	<b>\$1,004,700</b>
<b>STATUS</b>	<b>Replacement/ New</b>
<b>PHASE</b>	<b>Ongoing</b>
<b>DESCRIPTION</b>	<p>The mobile equipment fleet has a replacement value of \$13.0 million and must be maintained to meet the service levels expected by residents. The City has a fleet of 118 heavy-duty and mobile equipment that support Fire and Ambulance, Road Maintenance, Water and Sewer Maintenance, Solid Waste, Parks, Arenas and Administrative functions, plus 24 stationary engines for emergency power generation and fire pumping capacity.</p> <p>The replacement vehicles listed have passed their useful lives according to City practices. In addition, they are recommended for replacement according to a mechanical assessment carried out by mechanics. In the 2006 Infrastructure Needs Assessment by Ferguson, Simek and Clark Architects and Engineers, it was noted that nearly half of the City's fleet has exceeded its anticipated life span.</p> <p><b><u>Pickups – 43 units</u></b> According to the City of Yellowknife Fleet Management Practices, these vehicles should be reviewed for replacement after five years and replaced after eight years. We currently have 43 pickups and vans in the fleet and two of them are over ten years old. The average age of the fleet is five years. If the policy were followed, the average age of the fleet would be five years. There have been 41 pickups that have been replaced in the last eight years. Replacing the aging</p>

fleet will lower the O&M to operate the fleet. Five pickups have to be replaced every year to maintain the fleet to the policy standard. If the standard is not followed, more maintenance staff will have to be hired to maintain the fleet to a safe and operational level and there will be increased costs. Status: Good – meets standard. Note: Replacement increased from eight to ten years.

### **Medium-Duty Trucks – 8 units**

According to the City of Yellowknife Fleet Management Practices, these vehicles should be reviewed for replacement after eight years and replaced after ten years. The City currently has eight medium-duty trucks in the fleet, with none of them over ten years old. The average age of the fleet is four years. If the policy were followed, the average age of the medium-duty truck fleet would be five years. Status: Medium - duty trucks meet standard and no replacement medium trucks are planned.

### **Municipal Enforcement Vehicles – 4 units**

These are to be replaced every three years or 100,000 km. The average age of the fleet of four Municipal Enforcement vehicles is three years and one has over 100,000 km. Due to the high usage, Municipal Enforcement vehicles require a high amount of maintenance (nearly five times that of similar vehicles in the fleet). For this reason, it is important to maintain the replacement of the vehicles. One Municipal Enforcement vehicle must be replaced yearly to maintain the City standards and in order to reduce O&M costs and labour requirements. With the replacement of one vehicle this year, the City will meet the practice identified. Status: Good – standard is maintained.

### **Heavy Trucks – 18 units**

This vehicle class includes trailers, tandem tractors, dump trucks, and street sweepers. One of the heavy-duty trucks and trailers is due for replacement. The heavy

trucks are to be replaced every 12 years. Currently, the age of the fleet is ten years old, and if the replacement policy is followed, the average age should be six years old. Trucks are used for City projects and snow removal in the winter. The cost of operating these vehicles over hiring contractors is about half. Each truck is operated for about 1,000 hrs/yr, saving the City \$45,000/year each truck it operates rather than contracting out.

Trailers are reviewed when aged out. If practical, the trailer is re-furbished and returned to service. The dump trailer (due to more use and normal wear and tear) is replaced when aged out.

As trucks get older, increased maintenance and repairs are required, such as replacing motors and transmissions at costs of \$20,000 and \$10,000 respectively. Breakdowns inevitably occur when equipment is needed resulting in a cost to the City to engage contractors that is much higher than using our own resources. Condition: if replacement continues, heavy-duty fleet condition is good.

### **Heavy Equipment – 10 units**

Heavy equipment is to be replaced every 12 years, and two units are due for replacement. Currently the age of the fleet is six years old, and the average age should be six years old. Heavy equipment is used for City projects and snow removal in the winter. The cost of operating our equipment over hiring contractors is about half. Each piece of heavy equipment is operated for about 1,000 hrs/yr, saving the City \$45,000 per year for each piece of heavy equipment it operates. As heavy equipment gets older, increased maintenance and repairs are required, such as replacing motors and transmissions at a cost of \$30,000 and \$20,000 respectively. Breakdowns inevitably occur when equipment is needed resulting in a cost to the City to engage contractors.

The City has explored contracting out heavy equipment services and leasing vehicles, but recommends the acquisition of replacement vehicles as the most cost-effective option.. Condition: Heavy equipment fleet is in good condition.

### **Mobile Tractors – 8 units**

The average age of the fleet is six years. This includes Zambonis, skid steers, compactors, and forklifts. The anticipated life span is ten years. The average age of the fleet if replaced as per the schedule should be five years. This equipment is currently tasked with sidewalk maintenance in the winter. Work in the summer includes sidewalk resurfacing and cold mix patches, Community Services trail repairs, and grounds maintenance. Two units are due for replacement. Condition: Good.

### **Emergency Vehicles – 9 units**

This includes fire trucks, ambulances and water trucks. The average age of the fleet is 15 years. Due to increased demand, the replacement life cycle standard has been evaluated by Public Works and the Fire and Ambulance Division. The standard for replacement was reduced from 30 years to 20 years for most firefighting equipment. This was done after a replacement part was not available for a fire truck that was over 20 years old. The vehicle was out of service for 8 weeks until a part was finally found at a used car wrecker. Parts are no longer manufactured for vehicles over 20 years old.

Ambulances are now replaced on a 12-year cycle, due to the high amount of use and reliability issues with ambulances as they get older. We have three ambulances and one is replaced every four years. The newest is placed on “first out the door” service and the oldest is declared surplus. Status: Most of the Emergency Vehicles are due for replacement since re-evaluation of their life cycle. A new piece of Emergency equipment is due for replacement in 2017 when the new replacement schedule will be realized.



**Other Equipment – 34 units**

This class of equipment includes the miscellaneous equipment required by City departments to do their work. Included are: riding mowers, snowmobiles (Municipal Enforcement Division), All-terrain Vehicles (firefighters), Solid Waste Facility baler, light trailers (Community Services and Public Works), line-painters, crack sealing equipment, trailer-mounted water pumps, and ground thawing equipment. Equipment in this group have a varied life expectancy and replacement cost. Status: for the most part, this equipment group is in good shape and the replacement schedule allows for safe work and consistent work flow.

**Stationary Engines – 21 Units**

Our fleet mechanics also maintain and service 21 stationary engines. These include standby generators for City water and sewer supply and City facilities (City Hall, Fire and Ambulance Division, Multiplex/Fieldhouse). The stationary engines provide standby electricity on water and sewer services in times of power outages or natural disasters. The estimated value of the stationary engines is approximately \$4.8 million. Many of the existing engines are old; five are over 30 years old, 12 are over 20 years old, 14 are over ten years old, and only seven are under ten years. Parts are often unavailable for engines over 20 years old. Though these engines get little use, even small breakdowns may result in lengthy repairs.

The Mobile Reserve Fund is not used to replace Stationary engines though fleet resources are used to maintain them. It is recommended to departmental managers that the older stationary engines be replaced. Fleet-wide, it is recommended that one engine a year be replaced until all stationary engines are less than 20 years old.

**Summer Vehicles – 12 Units**

Summer vehicles are those that have been replaced but are still useful in a secondary or low priority role. There are nine light vehicles used mainly by Community Services Parks staff in the summer or as administration vehicles year round, and one heavy equipment class dump trailer used in winter as a backup or with a leased tractor for winter snow removal. If repair of a summer vehicle exceeds an estimated cost of \$500, the vehicle may be removed from service at the discretion of the Works Superintendent.

This project addresses City Council's Goal #4.1<sup>1</sup>.

**O&M IMPACT**

Maintenance costs will decrease if City of Yellowknife Fleet Management Practices are followed, due to reduced fuel consumption and repair costs. City residents will be highly satisfied with City services. If the fleet is replaced and a schedule followed, services will be more consistent and not interrupted due to equipment failure.

---

<sup>1</sup> Be accountable to residents by ensuring open and accessible information flow and accessible decision making.

<b>Vehicle Unit #</b>	<b>New / Replacement</b>	<b>Year</b>	<b>Replacement Year/Standard</b>	<b>Replacement Value</b>
1053-09 2009 Crown Victoria B53	Replacement	2009	2013	\$51,000
1122-09 BUSH HOT PROFESSIONAL SERIES M	Replacement	2009	2013	\$15,300
2019-96 MOBILE STREET SWEEPER	Replacement	1996	2008	\$367,200
2033-07 CAT 140M GRADER	Replacement	2007	2013	\$204,000
2100-01 2001 BOBCAT LOADER - INGERSOLL	Replacement	2001	2010	\$66,300
2110-97 97 FORD E350 AMBULANCE	Replacement	1997	2012	\$178,500
3129-04 ZAMBONI MODEL: 440	Replacement	2004	2014	\$122,400
Total				\$1,004,700



**CAPITAL FUND - 2014 Capital Projects**

---

		2014 Budget Recommended (\$000s)	Formula Funding (\$000s)	IT Reserve (\$000s)
	<u>Page #</u>			
<b>General Government</b>				
Tourism Marketing & Development	208	40	40	
		40	40	-
<b>Information Technology</b>				
Network Upgrades	209	25		25
GIS Enhancements	210	50		50
Server Replacement	211	25		25
Security Cameras	214	20		20
Secondary Site & Data Replication	215	10		10
Website Enhancements	216	15		15
Core Switch Upgrades	334	25		25
Virtualization	218	40		40
Automated Ticket Writer	335	40		40
		250	-	250
<b>Subtotal</b>		290	40	250

## CAPITAL FUND - 2014 Capital Projects

---

**DEPARTMENT** CORPORATE SERVICES

**DIVISION** INFORMATION TECHNOLOGY

**PROJECT** Core Switch Upgrades

**COST** \$25,000

**STATUS** New

**PHASE** 1 of 1

**DESCRIPTION** The City's network undergoes regular, incremental improvements to sustain its functionality. This strategy has proven to be an effective way to grow and expand the network to meet increasing demands and expectations. However, there remains the occasional need for a more significant investment to enhance the infrastructure and thus it is recommended that the City replace its core switch stack in 2014.

This equipment forms the very backbone of the City's network, but by 2014 it will be seven years old and approaching the end of its useful life. Therefore a timely replacement is crucial.

This enhanced foundation will protect the City's existing investment in its network, and ensure the network is able to meet current and future demands.

This project works toward City Council's Goals #1<sup>1</sup> and #4<sup>2</sup>, Objectives #1.4<sup>3</sup> and #4.4<sup>4</sup>, and Action #4(b)<sup>5</sup>.

**O&M IMPACT** There will be no direct impact on O&M expenditures. However, should this equipment fail, significant network outages will ensue.

- 
- <sup>1</sup> Affordability
  - <sup>2</sup> Continuous Improvement
  - <sup>3</sup> Emphasize fairness and transparency in financial decisions, program delivery and land assembly.
  - <sup>4</sup> Be a leader in innovation.
  - <sup>5</sup> Lead in innovation and best practices.



## CAPITAL FUND - 2014 Capital Projects

---

**DEPARTMENT** CORPORATE SERVICES

**DIVISION** INFORMATION TECHNOLOGY

**PROJECT** Automated Ticket Writer

**COST** \$40,000

**STATUS** New

**PHASE** 1 of 1

**DESCRIPTION** The Municipal Enforcement Division currently utilizes a two-part parking ticket. These tickets are printed by a local printer at a cost of approximately \$9.95 per 25 tickets. There are approximately 11,000 tickets issued each year at a cost of approximately \$4,400. The officers issuing the tickets hand write the offenders' information on the tickets which are then given to Municipal Enforcement Clerks who manually enter the information from the ticket onto the City's financial information system. This process is labour-intensive, taking up a significant amount of a clerk's work day. The Automated Ticket Writer would eliminate the need to print tickets as the unit prints the tickets as they are issued. The unit would also be capable of downloading the information directly to the City's financial information system, greatly reducing the time the staff spend doing data entry.

This project works toward City Council's Goals #1<sup>1</sup> and #4<sup>2</sup>, Objectives #1.4<sup>3</sup> and #4.4<sup>4</sup>, and Action #4(b)<sup>5</sup>.

**O&M IMPACT** This project will reduce O&M expenditures on paper tickets, and ensure ticket data are captured more efficiently and accurately.

- 
- <sup>1</sup> Affordability
  - <sup>2</sup> Continuous Improvement
  - <sup>3</sup> Emphasize fairness and transparency in financial decisions, program delivery and land assembly.
  - <sup>4</sup> Be a leader in innovation.
  - <sup>5</sup> Lead in innovation and best practices.



**CAPITAL FUND - 2014 Capital Projects**

---

	<u>Page #</u>	<u>2014 Budget Recommended (\$000s)</u>	<u>Formula Funding (\$000s)</u>	<u>Grants (\$000s)</u>
<b>Community Services</b>				
<b>Arenas</b>				
YKCA - Wiring	337	15	15	
YK Curling Club - Lighting	338	40	40	
<b>Parks/Trails</b>				
Ball Diamond Upgrade	339	25	15	10
Rental Equipment	239	40	40	
Sport & Multi-use Fields Upgrade - Range Lake North School Field	240	100	100	
Sport & Multi-use Fields Upgrade - Sir John Franklin High School Field	240	60	60	
Outdoor Fitness Equipment	340	75	5	70
Trail Development - Old Airport Road, McMahon Frame Lake & Tin Can Hill	321	290	290	
Paving - Niven Lake Trail	341	255	255	
<b>Pool</b>				
Locker Replacement	323	80	80	
Roof Resurfacing	342	120	120	
<b>Subtotal</b>		<u>1,100</u>	<u>1,020</u>	<u>80</u>



## CAPITAL FUND - 2014 Capital Projects

---

**DEPARTMENT** COMMUNITY SERVICES

**DIVISION** FACILITIES

**PROJECT** Yellowknife Community Arena – Wiring

**COST** \$15,000

**STATUS** New

**PHASE** 1 of 1

**DESCRIPTION** The Yellowknife Community Arena was built in 1982 and has served the needs of the community very well over the years. During maintenance of the facility and on advice of our electrical contractor, it has been determined that the wiring from the penalty box side of the facility to the main control box is in need of replacement.

This wiring controls power to the game clock, the facility's public address system and all of the arena on the penalty box side. A failure in the wiring system will result in this equipment not being functional.

This project works toward Council's Goal #2<sup>1</sup>.

**O&M IMPACT** There will be no additional costs for maintenance as this will be covered under our current budget for repairs and maintenance.

---

<sup>1</sup> Enhancing our built environment.

## CAPITAL FUND - 2014 Capital Projects

---

**DEPARTMENT** COMMUNITY SERVICES

**DIVISION** FACILITIES

**PROJECT** Curling Club - Lighting

**COST** \$40,000

**STATUS** Replacement

**PHASE** 1 of 1

**DESCRIPTION** The Yellowknife Curling Club was opened in 1988 and has served the needs of the community well in those years. In addition to local curling, the club has hosted a number of territorial and national events, as well as four Arctic Winter Games.

A facility of this age is considered to be in the adult portion of its life cycle and, as such, various upgrades are required to ensure that the building meets expectations for its life cycle and continues to operate in an efficient and effective manner.

The existing lighting system in the Curling Club is obsolete, and parts for repairs are difficult to find. In fact, ballasts for the lighting no longer exist.

This project will allow the City to upgrade the lighting system to T5 energy-efficient lighting.

This works toward Council's Goal #2<sup>1</sup>.

**O&M IMPACT** There will be no additional costs for maintenance as this will be covered under our current budget for repairs and maintenance.

---

<sup>1</sup> Enhancing our built environment.



**CAPITAL FUND - 2014 Capital Projects**

---

**DEPARTMENT**    **COMMUNITY SERVICES**

**DIVISION**        **FACILITIES**

**PROJECT**         **Ball Diamonds Upgrade**

**COST**             **\$25,000**

**STATUS**          **Replacement**

**PHASE**          **1 of 1**

**DESCRIPTION**    The City directly administers six ball diamonds: two at Fritz Theil Ballpark, two at Parker Field, one at William McDonald School, and one at St. Joseph School.

Several of the diamonds use shale that requires periodic replacement and conditioning. This project will allow for the purchase of shale to address this need.

This project would allow the department to replace the shale on the five remaining fields, improving the ball playing experience there.

**BUDGET**

Upgrade	\$25,000
<u>Less grant</u>	<u>\$10,000</u>
Total	\$15,000

This project works toward Council's Goal #2<sup>1</sup>.

**O&M IMPACT**    There will be no additional costs for maintenance as this will be covered under our current budget for repairs and maintenance.

---

<sup>1</sup> Enhancing our community environment.

## CAPITAL FUND - 2014 Capital Projects

---

<b>DEPARTMENT</b>	<b>COMMUNITY SERVICES</b>						
<b>DIVISION</b>	<b>FACILITIES</b>						
<b>PROJECT</b>	<b>Parks - Outdoor Fitness Equipment</b>						
<b>COST</b>	<b>\$75,000</b>						
<b>STATUS</b>	<b>New</b>						
<b>PHASE</b>	<b>1 of 1</b>						
<b>DESCRIPTION</b>	<p>Today we know that fitness activities and an active lifestyle are essential to improved health, longevity and enjoyment of life.</p> <p>All of the fitness equipment in the city is currently located indoors. By installing outdoor fitness equipment, Yellowknife residents of any age can have fun outdoors and get fit at the same time.</p> <p>This project would allow the department to purchase two diverse packages that would be installed in locations strategically chosen to attract the most use.</p> <p>Each park would be equipped with a nine-unit system providing 18 fitness stations and an opportunity to perform more than 72 exercises that provide several cardio options, full body and core strengthening, plus warm-up, stretching, balance and flexibility.</p> <p>Users of all ages and all fitness levels can enjoy these fitness stations.</p> <p><b>BUDGET</b></p> <table><tr><td>Equipment</td><td>\$75,000</td></tr><tr><td><u>Less grant</u></td><td><u>\$70,000</u></td></tr><tr><td>Total</td><td>\$ 5,000</td></tr></table>	Equipment	\$75,000	<u>Less grant</u>	<u>\$70,000</u>	Total	\$ 5,000
Equipment	\$75,000						
<u>Less grant</u>	<u>\$70,000</u>						
Total	\$ 5,000						

This project works toward Council's Goals #2<sup>1</sup> and #3<sup>2</sup>.

**O&M IMPACT** There will be no additional cost for maintenance, as this will be covered under our current budget for repairs and maintenance.



---

<sup>1</sup> Enhancing our built environment.

<sup>2</sup> Building social capital.



## CAPITAL FUND - 2014 Capital Projects

---

**DEPARTMENT** COMMUNITY SERVICES

**DIVISION** FACILITIES

**PROJECT** Paving Niven Lake Trail

**COST** \$255,000

**STATUS** New

**PHASE** 1 of 1

**DESCRIPTION** Currently there are 10.7 kilometres of trails within the City of Yellowknife. The paved McMahon/Frame Lake Trail represents two kilometers of that total.

The 2.1-kilometre Niven Lake Trail is popular with all residents of the city, not only those living in the area.

When the trails were developed in the 90s, housing in the area was limited. Continued development has increased recreational and commuter use of the trail.

To facilitate the continuing popularity of this trail, it is proposed to pave its entire length, giving it greater year-round accessibility for parents with strollers, senior citizens, and disabled persons.

Snow removal on a paved trail would be quicker and more thorough as it could be brushed with our equipment. The Niven Lake Trail would receive the same level of service that the McMahon/Frame Lake Trail currently receives in the winter months.

This project works toward Council's Goals #2<sup>1</sup> and #3<sup>2</sup>.

**O&M IMPACT** There will be no additional costs for maintenance as this will be covered under our current budget for repairs and maintenance.

---

<sup>1</sup> Enhancing our built environment.

<sup>2</sup> Building social capital.

## CAPITAL FUND - 2014 Capital Projects

---

**DEPARTMENT** COMMUNITY SERVICES

**DIVISION** PROGRAMS

**PROJECT** Ruth Inch Memorial Pool - Roof Resurfacing

**COST** \$120,000

**STATUS** Replacement

**PHASE** 1 of 1

**DESCRIPTION** The Ruth Inch Memorial Pool opened its doors to the public in the fall of 1988. The pool continues to be a popular facility for the citizens and visitors of Yellowknife. In 2010, the City awarded a tender to an engineering firm to do a life cycle analysis of the Ruth Inch Memorial Pool which identified items that needed to be addressed to ensure the pool meets its life expectancy. The roof was identified as one of the exterior elements that needed to be repaired within the next three to five years. The report stated that the average life expectancy of an asphalt rolled roof is 25 years which means that the roof should be scheduled for replacement.

The Community Services Department is recommending that funding be identified for replacement of the roof in the summer of 2014.

This project works toward Council's Objective #2.2<sup>1</sup>.

**O&M IMPACT** No immediate impact on O&M.

---

<sup>1</sup> Improve transit, roads, sidewalks, recreation facilities and trails with an emphasis on active transportation.



CAPITAL FUND - 2014 Capital Projects

---

		2014 Budget Recommended (\$000s)	Formula Funding (\$000s)
<b>Public Safety</b>			
	<u>Page #</u>		
<b>Fire &amp; Ambulance</b>			
Storage Facility	344	150	150
Thermal Imaging Cameras	345	25	25
FDM Software (Apparatus Maintenance Module)	346	30	30
<b>Subtotal</b>		<u>205</u>	<u>205</u>
<b>Planning &amp; Development</b>			
	<u>Page #</u>		
Smart Growth & Harbour Plan Initiatives	252	1,000	1,000
Streetscaping Initiatives (Downtown)	253	500	500
<b>Subtotal</b>		<u>1,500</u>	<u>1,500</u>



## CAPITAL FUND - 2014 Capital Projects

---

**DEPARTMENT** PUBLIC SAFETY

**DIVISION** FIRE AND AMBULANCE

**PROJECT** Storage Facility

**COST** \$150,000

**STATUS** New

**PHASE** 1 of 1

**DESCRIPTION** The Fire and Ambulance Division is currently storing equipment and apparatus (Engine 2) outside, exposed to the elements. There is a pressing need for an organized storage facility to accommodate efficiencies and proper care of spare equipment.

This project works toward City Council's Goal #4<sup>1</sup>.

**O&M IMPACT** Minimal

---

<sup>1</sup> Continuous Improvement



## CAPITAL FUND - 2014 Capital Projects

---

**DEPARTMENT** PUBLIC SAFETY  
**DIVISION** FIRE AND AMBULANCE  
**PROJECT** Thermal Imaging Cameras  
**COST** \$25,000  
**STATUS** Replacement  
**PHASE** 1 of 1  
**DESCRIPTION** The Fire and Ambulance Division is currently using thermal imaging cameras that are outdated in comparison to the technology available today. It is vital that firefighters have the best equipment available in order to ensure safe and effective rescues.  
  
This project works toward City Council's Goal #4<sup>1</sup>.  
**O&M IMPACT** Minimal

---

<sup>1</sup> Continuous Improvement

## CAPITAL FUND - 2014 Capital Projects

---

<b>DEPARTMENT</b>	<b>PUBLIC SAFETY</b>
<b>DIVISION</b>	<b>FIRE AND AMBULANCE</b>
<b>PROJECT</b>	<b>FDM Software (Apparatus Maintenance Module)</b>
<b>COST</b>	<b>\$30,000</b>
<b>STATUS</b>	<b>New</b>
<b>PHASE</b>	<b>1 of 1</b>
<b>DESCRIPTION</b>	<p>The Fire and Ambulance Division is currently using FDM software, but would like to upgrade its system to enhance the ability to manage the equipment and apparatus. The Asset Management and Preventative Maintenance modules will allow us to track apparatus and equipment service and maintenance. Currently, Public Works only tracks service of light apparatus. The Fire and Ambulance Division is responsible for heavy apparatus, small engines and equipment, and ancillary vehicles. The number of daily, weekly, monthly, and annual inspections that we do calls for a more sophisticated system to ensure safety and operational readiness.</p> <p>This project works toward City Council's Goal #4<sup>1</sup>.</p>
<b>O&amp;M IMPACT</b>	Minimal

---

<sup>1</sup> Continuous Improvement



**CAPITAL FUND - 2014 Capital Projects**

---

		<b>2014 Budget Recommended (\$000s)</b>	<b>Formula Funding (\$000s)</b>	<b>M.E.R. Reserve (\$000s)</b>	<b>MACA Capital Grant (\$000s)</b>
<b>Public Works &amp; Engineering</b>	<b><u>Page</u></b>				
<b>Fleet Management</b>	349				
1023-10 Crown Victoria Police Interceptor		52		52	
1102-04 F350 Ford 1-Ton		42		42	
1103-04 Ford E250 Service Van		36		36	
1124-04 Ford F150		33		33	
1125-04 Ford F150		33		33	
1174-09 '34" Exmark Mower'		7		7	
2022-08 Cat 140M Grader		208		208	
2064-08 Landfill Haul Truck		156		156	
2099-02 Freightliner Sweeper		375		375	
3130-04 Zamboni Ice-Resurfacers		125		125	
		<u>1,067</u>	-	<u>1,067</u>	-
<b>Engineering &amp; Garage</b>					
Garage- Fire Code & Safety Improvements	267	50	50		
<b>Roads &amp; Sidewalks</b>					
Road Rehabilitation	269	3,500	1,290		2,210
Traffic Lights UPS	273	60	60		
Drainage Improvements	274	50	50		
New Bus Shelters & Route Posts	275	20	20		
		<u>3,680</u>	<u>1,470</u>	-	<u>2,210</u>

**CAPITAL FUND - 2014 Capital Projects**

	<b>Page</b>	<b>2014 Budget Recommended (\$000s)</b>	<b>Formula Funding (\$000s)</b>	<b>Water &amp; Sewer User Fees (\$000s)</b>	<b>M.E.R. Reserve (\$000s)</b>	<b>Gas Tax Rebate (\$000s)</b>	<b>MACA Capital Grant (\$000s)</b>
<b>Solid Waste Management</b>							
<b>Landfill</b>							
Baling Facility Mechanical Upgrades	278	100				100	
Site Restoration	279	150	150				
Centralized Composting Project	280	50	50				
		<u>300</u>	<u>200</u>	<u>-</u>	<u>-</u>	<u>100</u>	<u>-</u>
<b>Community Energy Plan (CEP) Initiatives</b>							
CEP Implementation	283	85	85			-	
Energy Efficiency Projects	283	415	415			-	
		<u>500</u>	<u>500</u>	<u>-</u>	<u>-</u>	<u>-</u>	<u>-</u>
<b>Pumphouses/Liftstations (PHs/LSs)</b>							
Water Treatment Plant	286	1,500				1,500	
Liftstations Capital Upgrade	289	65				65	
Reservoir Flushing, Cleaning & Repairs	291	60		60			
Monitor & Controls Assessment & Upgrade	294	75				75	
Pumphouse & Liftstation Pipe Replacement	296	300				300	
<b>Other</b>							
Water Meter Replacement & Upgrade	297	25	25				
Fire Hydrant Repair/Upgrade	298	30	30				
Water Licence Study & Report Requirements	299	25	25				
<b>CMP Replacement Program</b>	<b>302</b>	<b>3,800</b>		<b>1,321</b>		<b>2,479</b>	
		<u>5,880</u>	<u>80</u>	<u>1,381</u>	<u>-</u>	<u>4,419</u>	<u>-</u>
<b>PW Subtotal</b>		<b><u>11,427</u></b>	<b><u>2,250</u></b>	<b><u>1,381</u></b>	<b><u>1,067</u></b>	<b><u>4,519</u></b>	<b><u>2,210</u></b>



## CAPITAL FUND - 2014 Capital Projects

---

DEPARTMENT	PUBLIC WORKS & ENGINEERING
DIVISION	FLEET MANAGEMENT
PROJECT	Upgrading of Fleet
COST	\$1,067,040
STATUS	Replacement/ New
PHASE	Ongoing
DESCRIPTION	<p>The mobile equipment fleet has a replacement value of \$13 million and must be maintained to meet the service levels expected by residents. The City has a fleet of 118 heavy-duty and mobile equipment that support Fire and Ambulance, Road Maintenance, Water and Sewer Maintenance, Solid Waste, Parks, Arenas and Administrative functions, plus 24 stationary engines for emergency power generation and fire pumping capacity.</p> <p>The replacement vehicles listed have passed their useful lives according to City practices. In addition, they are recommended for replacement according to a mechanical assessment carried out by mechanics. In the 2006 Infrastructure Needs Assessment by Ferguson, Simek and Clark Architects and Engineers, it was noted that nearly half of the City's fleet has exceeded its anticipated life span.</p> <p><b><u>Pickups – 43 units</u></b> According to City of Yellowknife Fleet Management Practices, these vehicles should be reviewed for replacement after five years and replaced after eight years. We currently have 43 pickups and vans in the fleet and two of them are over ten years old. The average age of the fleet is five years. If the policy were followed, the average age of the fleet would be five years. There have been 41 pickups replaced in the last eight years. Replacing the aging fleet will lower the O&amp;M</p>

to operate the fleet. Five pickups have to be replaced every year to maintain the fleet to the policy standard. If the standard is not followed, more maintenance staff will have to be hired to maintain the fleet to a safe and operational level and there will be increased costs. Status: Good – meets standard. Note: Replacement increased from eight to ten years.

### **Medium-Duty Trucks – 8 units**

According to City of Yellowknife Fleet Management Practices, these vehicles should be reviewed for replacement after eight years and replaced after ten years. The City currently has eight medium-duty trucks in the fleet, with none of them over ten years old. The average age of the fleet is four years. If the policy were followed, the average age of the medium-duty truck fleet would be five years. Status: Medium-duty trucks meet the standard and no replacements are planned.

### **Municipal Enforcement Vehicles – 4 units**

These are to be replaced every three years or 100,000 km. The average age of the fleet of four Municipal Enforcement vehicles is three years and one has over 100,000 km. Due to the high usage, Municipal Enforcement vehicles require a high amount of maintenance (nearly five times that of similar vehicles in the fleet). For this reason, it is important to maintain the replacement of the vehicles. One Municipal Enforcement vehicle must be replaced yearly to maintain the City standards and in order to reduce O&M costs and labour requirements. With the replacement of one vehicle this year, the City will meet the practice identified. Status: Good – standard is maintained.

### **Heavy Trucks – 18 units**

The 18 heavy-duty trucks and trailers, includes trailers, tandem tractors, dump trucks, and street sweepers. One of the heavy-duty trucks and trailers is due for replacement. The heavy trucks are to be replaced every 12 years. Currently, the age of the fleet is ten years old,

and if the replacement policy is followed, the average age should be six years old. Trucks are used for City projects and snow removal in the winter. The cost of operating these vehicles over hiring contractors is about half. Each truck is operated for about 1,000 hrs/yr, saving the City \$45,000/year for each truck it operates, rather than contracting out.

Trailers are reviewed when aged out. If practical, the trailer is refurbished and returned to service. The dump trailer (due to more use and normal wear and tear) is replaced when aged out.

As trucks get older, increased maintenance and repairs are required, such as replacing motors and transmissions at costs of \$20,000 and \$10,000 respectively. Breakdowns inevitably occur when equipment is needed, resulting in a cost to the City to engage contractors at a much higher cost than using our own resources. Condition: If replacement continues, heavy-duty fleet condition is good.

### **Heavy Equipment – 10 units**

Heavy equipment is to be replaced every 12 years, and two units are due for replacement. Currently, the fleet is six years old, and the average age should be six years old. Heavy equipment is used for City projects and snow removal in the winter. The cost of operating our equipment over hiring contractors is about half. Each piece of heavy equipment is operated for about 1,000 hrs/yr, saving the City \$45,000 per year for each piece of heavy equipment it operates. As heavy equipment gets older, increased maintenance and repairs are required, such as replacing motors and transmissions at a cost of \$30,000 and \$20,000 respectively. Breakdowns inevitably occur when equipment is needed, resulting in a cost to the City to engage contractors.

The City has explored contracting out heavy equipment services and leasing vehicles, but recommends the acquisition of replacement vehicles as the most cost-effective option. Condition: Heavy equipment fleet is in good condition.

### **Mobile Tractors – 8 units**

The average age of the fleet is six years. This includes Zambonis, skid steers, compactors, and forklifts. The anticipated life span is ten years. The average age of the fleet, if replaced as per the schedule, should be five years. This equipment is currently tasked with sidewalk maintenance in the winter. Work in the summer includes sidewalk resurfacing and cold mix patches, Community Services trail repairs, and grounds maintenance. Two units are due for replacement. Condition: Good.

### **Emergency Vehicles – 9 units**

This includes fire trucks, ambulances and water trucks. The average age of the fleet is 15 years. Due to increased demand, the replacement life cycle standard has been evaluated by Public Works and the Fire and Ambulance Division. The standard for replacement was reduced from 30 years to 20 years for most firefighting equipment. This was done after a replacement part was not available for a fire truck that was over 20 years old. That vehicle was out of service for 8 weeks until a part was finally found at a used car wrecker. Parts are no longer manufactured for vehicles over 20 years old.

Ambulances are now replaced on a 12-year cycle due to heavy use and reliability issues with ambulances as they get older. We have three ambulances and one is replaced every four years. The newest is placed on “first out the door” service and the oldest is declared surplus. Status: Most of the Emergency Vehicles are due for replacement since the re-evaluation of their life cycle. A new piece of Emergency equipment is due for



replacement in 2017, when the new replacement schedule will be realized.

**Other Equipment – 34 units**

This class of equipment includes the miscellaneous equipment required by City departments to do their work. Included are: riding mowers, snowmobiles (Municipal Enforcement Division), all-terrain vehicles (firefighters), Solid Waste Facility baler, light trailers (Community Services and Public Works), line-painters, crack sealing equipment, trailer mounted water pumps, and ground thawing equipment. Equipment in this group have a varied life expectancy and replacement cost. Status: for the most part, this equipment group is in good shape and the replacement schedule allows for safe work and consistent work flow.

**Stationary Engines – 21 Units**

Our fleet mechanics also maintain and service 21 stationary engines. These include standby generators for City water and sewer supply and City facilities (City Hall, Fire Hall, Multiplex/Fieldhouse). The stationary engines provide standby electricity on water and sewer services during power outages or natural disasters. The estimated value of the stationary engines is approximately \$4.8 million. Many of the existing engines are old; five are over 30 years old, 12 are over 20 years old, 14 are over ten years old, and only seven are under ten years. Parts are often unavailable for engines over 20 years old. Though these engines get little use, even small breakdowns may lead to lengthy repairs.

The Mobile Reserve Fund is not used to replace Stationary engines though fleet resources are used to maintain them. It is recommended to departmental managers that the older stationary engines be replaced. Fleet-wide, it is recommended that one engine a year be replaced until all stationary engines are less than 20 years old.

**Summer Vehicles – (12)**

Summer vehicles are those that have been replaced but remain useful in a secondary or low priority role. There are nine light vehicles used mainly by Community Services Parks staff in the summer, or as administration vehicles year-round, and one heavy equipment class dump trailer used in winter as a backup or with a leased tractor for winter snow removal. If repair of a summer vehicle exceeds an estimated cost of \$500, the vehicle may be removed from service at the discretion of the Works Superintendent.

This project addresses City Council's Goal #4.1<sup>1</sup>.

**O&M IMPACT**

Maintenance costs will decrease if City of Yellowknife Fleet Management Practices are followed, due to reduced fuel consumption and repair costs. City residents will be highly satisfied with City services. If the fleet is replaced according to schedule, services will be more consistent and not interrupted due to equipment failure.

---

<sup>1</sup> Be accountable to residents by ensuring open and accessible information flow and accessible decision making.



<b>Vehicle Unit #</b>	<b>New / Replacement</b>	<b>Year</b>	<b>Replacement Year/Standard</b>	<b>Replacement Value</b>
1023-10 CROWN VICTORIA POLICE INTERCEPTOR	Replacement	2010	2014	\$52,000
1102-04 2004 F350 FORD 1-TON	Replacement	2004	2014	\$41,600
1103-04 2004 FORD E250 SERVICE VAN	Replacement	2004	2014	\$36,400
1124-04 FORD F150	Replacement	2004	2014	\$33,280
1125-04 FORD F150	Replacement	2004	2014	\$33,280
1174-09 '34' EXMARK MOWER	Replacement	2009	2014	\$7,280
2022-08 CAT 140M GRADER	Replacement	2008	2014	\$208,000
2064-08 LANDFILL HAUL TRUCK	Replacement	2008	2014	\$156,000
2099-02 FREIGHTLINER SWEEPER	Replacement	2002	2014	\$374,400
3130-04 ZAMBONI ICE-RESURFACER	Replacement	2004	2014	\$124,800
Total				\$1,067,040



## RESERVE FUND

---

Reserves are unfunded which means that a separate bank account is not kept for each individual reserve. The Reserves are funded through all of the City's financial assets, namely cash on hand, accounts receivable and land held for resale. All interest earned is recorded in the General Fund as revenue. The amount earned or paid out in overdraft interest varies on an annual basis depending on expenditures. For instance, the construction of the twin pad arena impacts the General Fund's interest revenue. The impact of the Reserve Fund is the decreased balance in the reserve offset by a decrease in financial assets. How transfers of revenue are recorded in each reserve, and the purpose of each reserve follows:

Information Technology Reserve: Amounts approved by Council for future information technology are transferred to the Information Technology Reserve.

Major Community Facility Reserve (M.C.F.R.): Amounts approved by Council for future community facilities are transferred to the Major Community Facility Reserve.

Mobile Equipment Replacement Reserve (M.E.R.R.): Amounts budgeted for future mobile equipment replacement are transferred to the Mobile Equipment Replacement Reserve.

Waterfront Development Reserve: Amounts approved by Council for future waterfront development are transferred to the Waterfront Development Reserve.

Downtown Development Reserve: Starting in 2002, 25% of parking meter revenue is transferred to the Downtown Development Reserve to fund future projects that impact the downtown area.

Heritage Reserve: To develop and maintain heritage sites.

Samuel Colley Donation Reserve: To provide for the Yellowknife Public Library.

Twin Pine Hill Trail Reserve: In 2005 and 2006, \$125,000 was transferred to this reserve for the development of the Twin Pine Hill Trail.

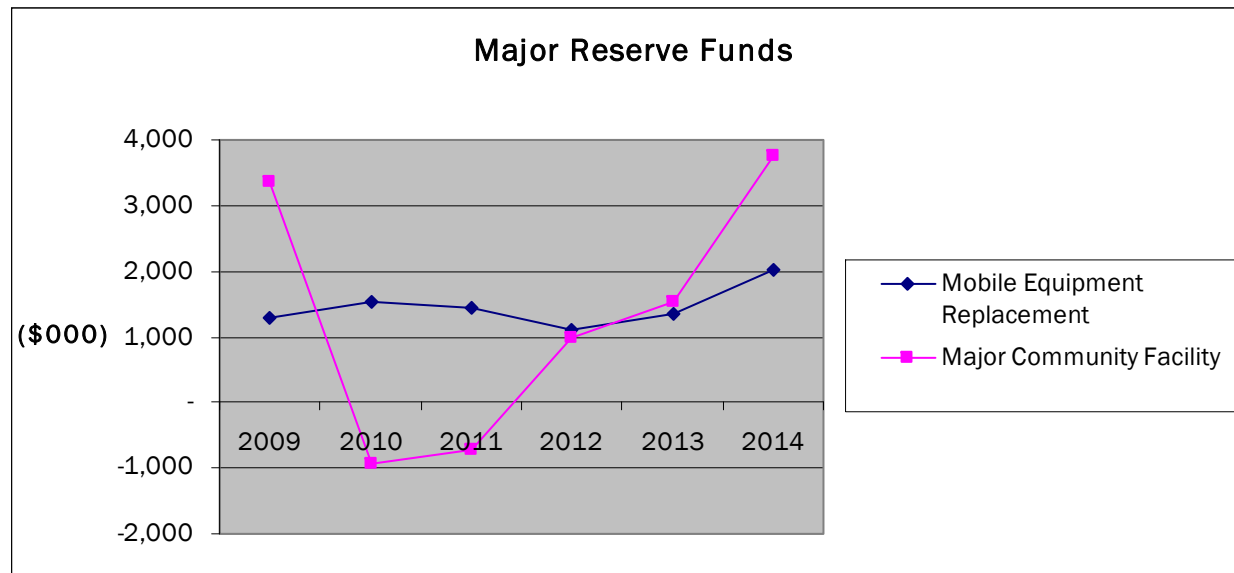

## RESERVE FUND

Reserves	2010 Actual (\$000's)	2011 Budget (\$000's)	2011 Forecast (\$000's)	2012 Budget (\$000's)	2013 Budget (\$000's)	2014 Budget (\$000's)
<b>Information Technology</b>						
Opening Balance	871	635	784	279	266	226
To Capital Fund	(387)	(637)	(780)	(313)	(340)	(250)
From Capital Fund	300	275	275	300	300	600
	784	273	279	266	226	576
<b>Major Community Facility</b>						
Opening Balance	3,370	(1,467)	(919)	(706)	990	1,532
To Capital Fund	(6,991)	-	(254)	-	-	-
From Capital Fund	2,702	467	467	1,696	542	2,230
	(919)	(1,000)	(706)	990	1,532	3,762
<b>Mobile Equipment Replacement</b>						
Opening Balance	1,298	1,122	1,521	1,432	1,100	1,340
To Capital Fund	(873)	(1,259)	(1,206)	(1,449)	(1,005)	(1,067)
From Capital Fund	1,096	1,117	1,117	1,117	1,245	1,760
	1,521	980	1,432	1,100	1,340	2,033
<b>Downtown Development</b>						
Opening Balance	87	78	264	95	137	180
To Capital Fund	(34)	-	(250)	-	-	-
To General Fund	(7)	(78)	(78)	(78)	(78)	(78)
From Land Fund	110	-	39	-	-	-
From General Fund	108	105	120	120	121	121
	264	105	95	137	180	223
<b>Heritage Committee</b>						
Opening Balance	17	17	48	48	48	48
From General Fund	31	-	-	-	-	-
	48	17	48	48	48	48
<b>Samuel Colley Library Donation</b>						
Opening Balance	134	199	200	200	200	200
To Capital Fund	-	-	-	-	-	-
From Capital Fund	65	-	-	-	-	-
From Bank Interest	1	-	-	-	-	-
	200	199	200	200	200	200
<b>Twin Pine Hill Trail</b>						
Opening Balance	258	258	260	260	85	0
To Capital Fund	-	(25)	-	(175)	(85)	-
From Capital Fund	-	-	-	-	-	-
From Bank Interest	2	-	-	-	-	-
	260	233	260	85	0	0
<b>Waterfront Development</b>						
Opening Balance	80	80	80	80	80	80
To Capital Fund	-	-	-	-	-	-
	80	80	80	80	80	80
	2,239	887	1,689	2,907	3,607	6,923
Opening Balance	6,116	923	2,239	1,689	2,907	3,607
Transfers	(3,877)	(35)	(550)	1,218	700	3,316
Closing Balance	2,239	888	1,689	2,907	3,607	6,923



**LONG-TERM DEBT**

	2010 Actual (\$000)	2011 Budget (\$000)	2011 Forecast (\$000)	2012 Budget (\$000)	2013 Budget (\$000)	2014 Budget (\$000)
<b>Outstanding Long-term Debt</b>						
Opening Balance	3,843	3,147	3,136	2,400	1,751	1,278
Capital Fund Debt Repaid	(707)	(746)	(736)	(649)	(473)	(319)
Closing Balance	3,136	2,401	2,400	1,751	1,278	959
<b>Comprised of</b>						
General Capital	3,136	2,401	2,400	1,751	1,278	959
	3,136	2,401	2,400	1,751	1,278	959

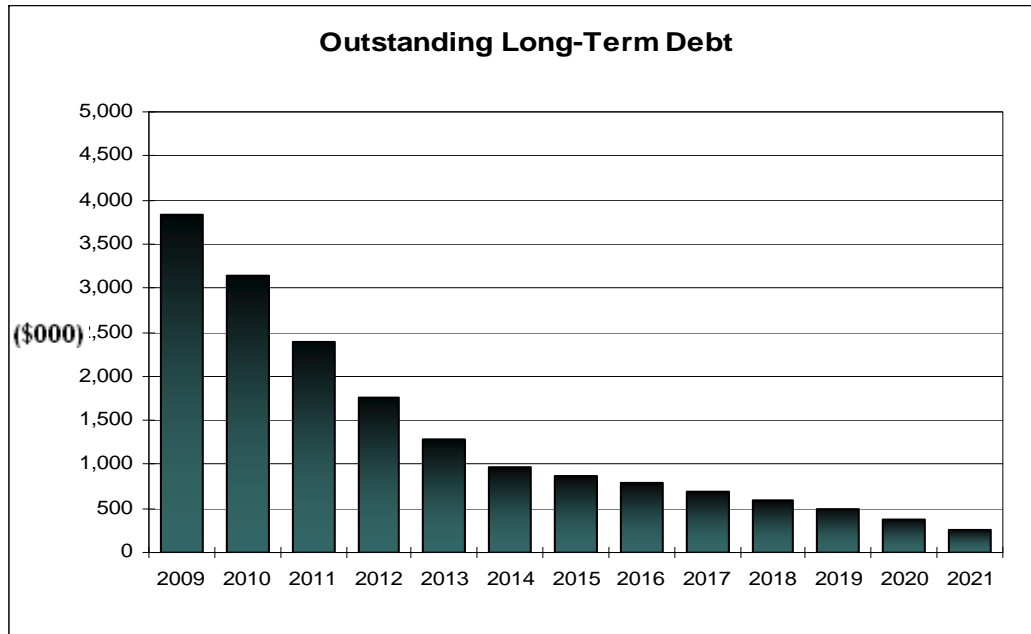

## LONG-TERM DEBT

	2010 Actual (\$000)	2011 Budget (\$000)	2011 Forecast (\$000)	2012 Budget (\$000)	2013 Budget (\$000)	2014 Budget (\$000)
<b>General Capital</b>						
<b>2001 Debenture #233,</b> authorized by By-law 4130, to finance part of the 2001 paving program, with annual payments of \$33,760, including principal and interest at 5.56%, expiring September, 2011.	29	-	-	-	-	-
<b>2001 Debenture #234,</b> authorized by By-law 4131, to finance part of 2001 paving program, with annual payments of \$80,406, including principal and interest at 5.50%, expiring September, 2011.	70	-	-	-	-	-
<b>2002 Debenture #235,</b> authorized by By-law 4176 to finance the 2002 road rehabilitation program, with annual payments of \$197,898, including principal and interest at 6.14%, expiring May, 2012.	345	168	168	-	-	-
<b>2002 Debentures #236 and 237,</b> authorized by By-laws 4177 and 4178 to finance traffic lights, with annual payments of \$22,065, including principal and interest at 6.14%, expiring May, 2012.	38	18	18	-	-	-
<b>CIBC Debenture #239,</b> authorized by By-law 4213 to finance completion of phase one of the twin pad arena, with annual payment of \$140,098 including principal and interest at 5.81%, expiring March 2023.	1,254	1,187	1,187	1,115	1,039	959
<b>2003 Debenture #240</b> authorized by By-law 4244 to finance the 2003 road rehabilitation program, with annual payment of \$191,254 including principal and interest at 4.82%, expiring July 2013.	512	345	345	170	-	-
<b>2004 Debenture #242</b> authorized by By-law 4280 to finance the 2004 road rehabilitation program, with annual payment of \$251,268 including principal and interest at 5.109% expiring July 2014.	889	683	683	466	239	-
	<b>3,136</b>	<b>2,401</b>	<b>2,400</b>	<b>1,751</b>	<b>1,278</b>	<b>959</b>



**LONG-TERM DEBT**

Principal Payments and Interest Expenditures		2010	2011	2012	2013	2014	2015	2016	2017 &	Total From
		Actual	Forecast	Budget	Budget	Budget	Estimated	Estimated	Thereafter	2012
		(\$000)	(\$000)	(\$000)	(\$000)	(\$000)	(\$000)	(\$000)	Projected	Onwards
									(\$000)	(\$000)
<b>General</b>										
	233 Principal	30	29	-	-	-	-	-	-	-
	Interest	3	1	-	-	-	-	-	-	-
		33	30	-	-	-	-	-	-	-
	234 Principal	73	70	-	-	-	-	-	-	-
	Interest	7	3	-	-	-	-	-	-	-
		80	73	-	-	-	-	-	-	-
	235 Principal	166	177	168	-	-	-	-	-	168
	Interest	25	14	32	-	-	-	-	-	32
		191	191	200	-	-	-	-	-	200
	236 / 237 Principal	19	20	19	-	-	-	-	-	19
	Interest	3	2	4	-	-	-	-	-	4
		22	22	23	-	-	-	-	-	23
	239 Principal	64	67	71	75	80	84	89	788	1,187
	Interest	74	70	66	61	57	52	47	156	439
		138	137	137	136	137	136	136	944	1,626
	240 Principal	159	167	175	171	-	-	-	-	346
	Interest	29	21	12	4	-	-	-	-	16
		188	188	187	175	-	-	-	-	362
	242 Principal	196	206	216	227	239	-	-	-	682
	Interest	51	41	30	19	7	-	-	-	56
		247	247	246	246	246	-	-	-	738
<b>Total</b>	Principal	707	736	649	473	319	84	89	788	2,402
	Interest	193	152	144	84	64	52	47	156	547
		900	888	793	557	383	136	136	944	2,949

## LONG-TERM DEBT

### Legal Borrowing Limit

Year	Assessed Values (\$000's)	Total Revenue (\$000's)	Legal Limit (\$000's)	Policy Limit (\$000's)	Debt Balance (\$000's)	Note (1)
1995	1,198,546		239,709	59,927	29,590	
1996	1,224,364		244,873	61,218	26,539	
1997	1,250,581		250,116	62,529	26,821	
1998	1,262,300		252,460	63,115	24,034	(2)
1999	1,281,385		256,277	64,069	20,720	
2000	1,249,584		249,917	62,479	19,117	
2001	1,265,922		253,184	63,296	15,123	
2002	1,314,146		262,829	65,707	13,253	(2)
2003	1,388,128		277,626	69,406	13,068	
2004	1,437,217		143,722	71,861	14,910	
2005	1,495,756		149,576	74,788	10,686	
2006	1,524,748		152,475	76,237	8,721	(2)
2007	1,862,823		186,282	93,141	6,422	
2008	1,911,676	52,683	105,366	95,584	4,971	
2009	1,951,056	54,293	108,586	97,553	3,843	
2010	1,984,644	58,674	117,348	99,232	3,136	
2011	2,002,337	59,689	119,378	100,117	2,400	
2012	2,024,486	60,419	120,839	101,224	1,751	
2013	2,047,443	61,405	122,809	102,372	1,278	(3)
2014	2,068,924	62,784	125,568	103,446	959	(3)

**Note:**

- (1) Prior to 2004, the City's legal limit was 20% of the assessed value of property as per *Cities, Towns and Villages Act* Section 150(2). In 2004, under the *Cities, Towns and Villages Act* Section 112(1), the legal limit was changed to 10% of assessment, and debt service payments were not to exceed 20% of revenue. However, starting from 2008, legal debt limit has changed. According to Section 167 of *Cities, Towns and Villages Act*, borrowing limit is two times total eligible revenue and debt service is 25% of revenue. As of December 31, 2010, our debt service payments were 1.69% of total revenue and total debt was 0.16% of assessment. The policy limit is 5% of property assessed values.
- (2) In 1998, 2002 and 2006, City conducted general assessment.
- (3) For 2013 and 2014, the assessed values are projection only.



# LONG-TERM DEBT

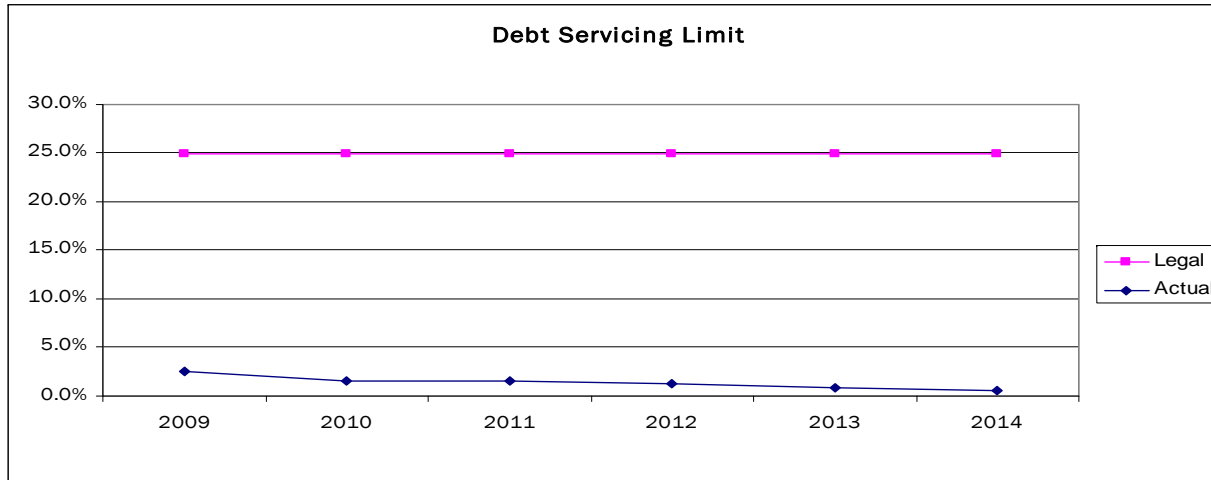

Legal debt servicing limit is 25% of total eligible revenue. City's debt servicing in 2009-2014 is far below legal limit.

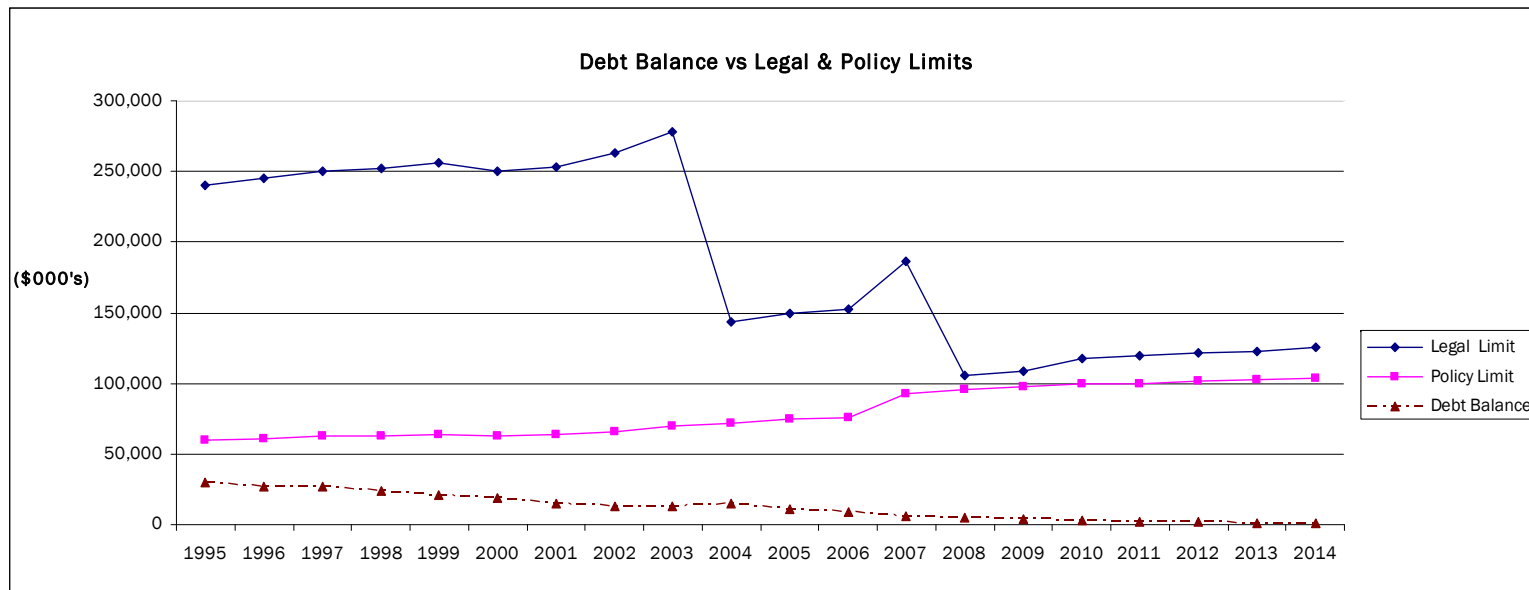

Legal limit is two times the eligible revenue and City's policy limit is 5% of assessment. City's debt balance is far below the legal and policy limits.



THIS PAGE LEFT BLANK INTENTIONALLY



### 10-Year Capital Improvement Plan (2012 – 2021)

The 10-Year Capital Improvement Plan (“Plan”) reflects the capital expenditures that the City can afford within the current funding envelope. It attempts to address what is believed necessary to maintain infrastructure, address environmental issues and deal with growth. It also documents the progress the City has made in attaining its financial goals, and provides a clear path to a financially sound future.

Crucial to the success of any forecasting exercise are the key assumptions used in preparing the Plan.

#### Key Assumptions

To develop the Plan, information was compiled utilizing the following assumptions:

- The 2012, 2013 and 2014 capital expenditures are based on the draft budgeted expenditures as outlined in this budget document.
- 2015 – 2021 is based on the best estimates of required future “core” funding levels for capital work projects.
- Formula funding and infrastructure funding from the GNWT are not expected to decrease over the ten-year period.
- Any infrastructure grant funding (e.g. Gas Tax Rebate and MACA Capital Grant) is used to supplement the annual core funding levels.
- Development costs for residential and industrial subdivisions are not included in this Plan, as it is assumed that all future development costs will be recovered from land sales.
- The Plan anticipates reviewing the City’s requirement to enter into long-term debt for core funding requirements, such as road rehabilitation.
- Council will follow Budget Policy 18 – Capital Asset Management Policy – which requires that the greater of:
  - 10% of taxation revenue, or
  - debt servicing costs on long-term debtbe transferred to the Capital Fund. This policy has not been adhered to for several years.

### Infrastructure Gap

The Infrastructure Needs Assessment Report commissioned in 2006 forecasted a \$67.8 million infrastructure gap in the City. The City has been using the report to support funding requests to other orders of government, and to assist with the prioritization of capital projects. This has helped the City address some immediate needs since 2006. However, based on the Capital Investment plan that is currently envisioned, this gap is expected to increase to approximately \$74 million by 2016. The growth in the gap may be reduced in later years if long-term debt is used for infrastructure replacement or for future major capital projects.

Currently, planned capital expenditures over the next 10 years are \$209 million. An Asset Analysis was conducted in 2011 which indicates that there is a need to address a significant gap in linear assets immediately. The City’s road network and its water and sewer networks require an immediate investment of \$42.4 million to address portions of those networks that are below acceptable condition levels. If this backlog can be addressed in the next three to five years, normal levels of investment in aging infrastructure could be re-established that would maintain these networks at a satisfactory level. Over a ten-year period, \$246 million should be invested in the City’s infrastructure in order to begin to address this gap. This cannot be accomplished within the current planning environment.

In order to address this issue, the City is embarking upon a long-term asset management plan which would guide the City’s investment in its existing infrastructure over the next 25-year period. The asset management plan will include provisions for borrowing where necessary, provisions for the establishment of viable reserve funds to address the need for new or replacement infrastructure and an investment plan for those reserves.

It has been six years since the City used long-term debt to fund core funding requirements such as road rehabilitation, and has been able to avoid the overall negative impact that principal and interest payments would have on property taxes and a financially sound future for the City. However, large capital projects such as the water treatment plant replacement would be more appropriately financed by borrowing, given

the City's existing infrastructure gap within our core areas – water and sewer infrastructure, roadways and sidewalks, and our fleet of vehicles – as well as historically low interest rates when compared to the inflationary cost of non-residential construction.

### Major Capital Projects

#### General Government

The communications infrastructure investment will continue through 2012. This investment has already resulted in improved communications equipment leading to better safety for firefighters and increased efficiency of wireless communications amongst municipal departments. Future investment will include a major addition to our city-wide communications capabilities and will allow the City the potential to take advantage of some significant efficiency saving opportunities. Total investment will be \$2.5 million.

The cost of City Hall renovations in 2015 is currently identified at \$2 million. The City has seen significant growth since the facility was first built and its services have expanded. The City is also working towards establishing a “one-stop shopping” model for services that residents obtain from City Hall, requiring a retrofit of the building. The age of the building is beginning to show as operating expenses, particularly heating and ventilation, are continually increasing. The Council Chambers are in major need of modernization to allow better participation by the public. Finally, the security of employees and other resources needs to be improved and only a reconfiguration of City Hall can accomplish this. It is estimated that approximately \$3.5 million will be required to retrofit this 35-year-old building to meet today's needs, and that investment needs to take place sooner than 2015.

#### Community Services

Library and Arts/Cultural Centre – Administration is recommending that the existing library can continue to serve the needs of residents well into the future by simply expanding the library rather than building a new one. Based on the 10-Year Financial Plan, there should be sufficient funds available in the Major Community Facility Reserve by 2015 to complete a detailed renovation to the library at an estimated cost of \$3 million.

#### Public Works

CMP Replacement Program – The replacement of deteriorated corrugated metal pipes (CMP) first began in 1984. Anticipated to be a 25-year program, there remains a significant amount of investment left to complete the project. It is estimated that, at the current level of investment, it would take longer than seven years. Over the next ten years, the City is budgeting to spend more than \$29 million to replace the aging underground water and sewer infrastructure in Yellowknife. Other water and sewer projects totaling just over \$11 million will also be undertaken over the next ten years.

Other Water and Sewer Infrastructure – Just as important as the underground infrastructure are the buildings and equipment that form part of the water delivery system that provides residents with excellent water quality. Expansion of the water reservoir will be completed in 2012. The City will also be starting on a project to replace the City's water treatment plant and Pumphouse #1. The first phase to begin in 2012 will consist of the selection of the treatment system and the engineering and design of the plant. The total estimated cost of this project is over \$20 million. The City will be using the Gas Tax Rebate funding (federal funding), formula funding (GNWT funding) and water and sewer user fees (municipal funding) to cover the costs of this important project.

Given the size of this investment and the need to continue to address the infrastructure gap in our linear assets, it would be prudent to borrow to complete this project and allocate the existing reserves to the previously mentioned CMP project and toward expanding our road rehabilitation program. The cost of debt is at an all-time low and the costs for non-residential construction continue to increase at a pace higher than normal inflation.

Road Rehabilitation (paving and repaving) – Historically, a majority of the road rehabilitation program has been financed by long-term borrowing (debentures). In 2005, however, the City decided to reduce its reliance on long-term borrowing while at the same time maintaining funding levels for road rehabilitation at a minimum of \$2 million per year. This level of investment has not been sufficient, as evidenced by the results of the 2011 Asset Analysis conducted by Dillon and Associates on behalf of the



City. That analysis indicates that there is an immediate need to invest \$11.4 million in our existing road system just to address those roads that are in immediate need of reconstruction or overlay.

The City is using formula funding (GNWT) to finance the costs of road rehabilitation and, over the next ten years, the City plans to invest more than \$32 million. Some road rehabilitation is also accomplished at the same time as the CMP replacement program using funds from that program.

Kam Lake Bypass Road (Airport West) – The Kam Lake Bypass road was completed in 2012 with a chip-sealed surface. Over the next two to three years, the City will complete this project by applying an asphalt surface to the road and completing the greenway recreation corridor which runs alongside it. The costs to provide this bypass were funded through a 50% partnership with the GNWT Department of Transportation. The GNWT has already committed its 50% share. The City will complete its 50% share over the next year. The City's share of this project will be obtained from a combination of land sales and/or long-term borrowing. Sales of lots in the Engle Business District will be crucial to fund the City's share of this project and to pay the debt servicing costs on an annual basis.

### **Solid Waste Management**

Landfill Expansion – The current cell of the landfill will be at capacity in the near future. Between 2012 and 2014, the City will expand into a new site adjacent to the existing landfill. Reclamation of the existing facility will be completed in 2014. The estimated cost of just over \$2 million is being funded from formula funding, Gas Tax Rebate and federal government Infrastructure Stimulus Funding.

### **Financing Capital Projects**

The City uses GNWT formula funding, government grants, property taxes, water and sewer fees, and solid waste levies to fund capital projects and reserve funds. Currently part of the property tax revenue is used for debt servicing costs but, as debt servicing costs decrease, budget policy requires that a minimum of 10% of property tax revenue be used to finance capital projects.

The City has two major reserve funds. They are the Major Community Facility Reserve and the Mobile Equipment Reserve. The Major Community Facility Reserve is used to fund major capital projects such as the City Hall and Library renovations. The Mobile Equipment Reserve is used to fund the replacement of the City's fleet of vehicles.

### **Long-Term Debt**

The City decided about six years ago to reduce its reliance on long-term borrowing to fund core capital spending obligations, such as road rehabilitation. As a result, the City has reduced its long-term debt significantly. The Ten-year Financial Plan anticipates reducing the long-term debt of the City from \$2.4 million in 2011 to less than \$300,000 by 2021. It is estimated that the debt servicing costs will be reduced from a high of \$880,000 in 2011 to a low of \$135,000 in 2021.

As stated before, however, this reduced reliance on debt is now having an adverse effect on addressing core capital requirements and the portion of the infrastructure deficit related to the linear assets is growing rather than shrinking. Relying on long-term debt for the replacement or refurbishment of major assets is being investigated and could increase the debt levels in the short to medium term.

### **Summary**

Over the 2012 to 2021 period, planned capital expenditures of the City will average \$16.3 million. Based on the plan, these requirements will be funded totally from cash reserves. However, the recent Asset Analysis indicates that the City needs to spend an average of \$22.8 million per year (much of it in the early years) to adequately address the infrastructure gap. It is this difference that the City will attempt to address with its Long-Term Asset Management Plan. As well, there is a concern that since the non-residential construction index is higher than other inflationary indices it may be difficult to keep up with the infrastructure requirements using only cash reserves. This means that it may be more economically advantageous for the City to enter into debt at a much lower rate than 5.7%, rather than wait until the City has accumulated sufficient balances in its MCFR to fund projects with cash.

## 10-YEAR FINANCIAL PLAN

---

The City continues to benefit from outside funding sources such as the MACA Capital Grant and Gas Tax Rebate. However, the City has continually transferred less from the General Fund to the Capital Fund than recommended under the policies established by Council, thus limiting the City's ability to address the gap. In other words, the City's tax base has not held up its end when it comes to addressing the City's infrastructure issues since the problem was fully quantified in 2006. The Long-Term Asset Management Plan will attempt to resolve this.

